



1 9 5 3

2 0 2 3



Al **Sig. Luigi De Luca**

che ha dato vita ad un successo

che dura **70 anni!**

To **Mr Luigi De Luca**

who started a **70-year**

success story!







Da 70 anni il nostro impegno è improntato a realizzare la miglior offerta di complementi dal design italiano per **innovazione, ampiezza di gamma e competitività**. Il nostro servizio ha il fine ultimo di creare valore per collaboratori, partner e clienti, unendo la professionalità alla responsabilità sociale e ambientale.

**Dal 1953, diamo il tocco finale per il tuo bagno.**

For 70 years, our commitment has been focused on making the best offer of complements from Italian design in terms of **innovation, range breadth and competitiveness**. Our service has the ultimate goal of creating value for employees, partners and customers, combining professionalism with social and environmental responsibility. **Since 1953, we have been giving**

**your bathroom's final touch.**

1 9 5 3 - 2 0 2 3

**1953**

**Azienda fondata  
da Luigi De Luca.**

Company founded  
by Luigi De Luca.

**1972**

**Prima serie in ABS.**

First range in ABS

**1977**

**MoMA** June 27, 1977  
In permanent Design Collection  
of the Museum of Modern Art  
in New York

**GEDY entra al MOMA  
di New York con Cucciolo.**

GEDY enters New York's  
MOMA with Cucciolo.

**1994**

**Prima serie  
di accessori in metallo.**

First range  
of metal accessories.

**1968**

**Produzione accessori bagno  
in legno, porcellana e resina.**

Production of bathroom  
accessories in wood,  
porcelain and resin.

**1974**

**Nasce il Cucciolo.**

The Cucciolo  
is created.

**1983**

**Fondazione di GEDY  
Iberica S.A.**

GEDY Iberica S.A.  
is founded.

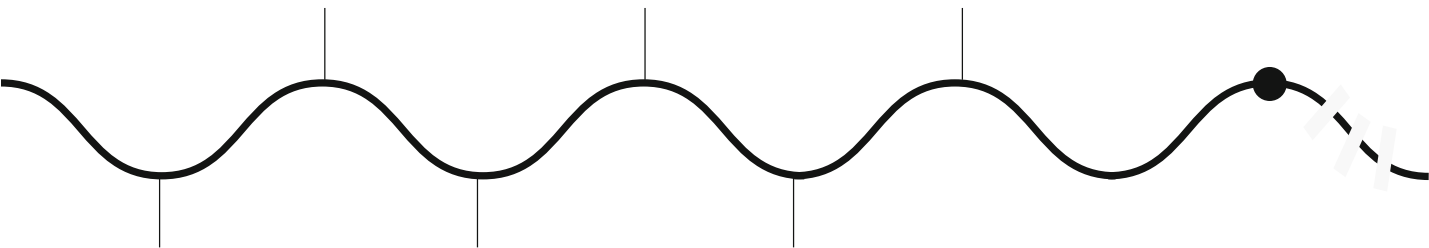

## 2011

**Green Good Design Award by Museum of Architecture & Design Chicago con lo sgabello Yannis.**

Green Good Design Award by Museum of Architecture & Design Chicago with Yannis stool.

## 2023

**Settantesimo anniversario dalla fondazione. Lancio della "nuova" identità GEDY.**

Seventieth anniversary. Launch of the "new" GEDY identity.

## 2002

**Trasferimento uffici a Origgio e ampliamento magazzino.**

Offices transferred to Origgio and expansion of warehouse.

## 1997

**Acquisizione e trasferimento del magazzino ad Origgio.**

Acquisition and transfer of warehouse to Origgio.

## 2010

**Automazione del sistema di spedizione.**

Automation of shipment system.

## 2013

**Sessantesimo anniversario dalla fondazione. Lancio della "nuova" identità Gedy Premio miglior stand Cersaie.**

Sixtieth anniversary. Launch of the "new" GEDY identity. Best stand award by Cersaie fair.



1 9 5 3  
2 0 2 3

# Indice.

## SERIE DA MURO. WALL SERIES.

06

2900 _____	192	Fuji _____	144	Nevis _____	122
Atena _____	62	Gea _____	42	New Jersey _____	130
Azzorre _____	22	Genziana _____	180	Olimpo _____	160
Bernina _____	110	Glamour _____	88	Outline _____	34
Bridge _____	60	Gran Torino _____	104	Pirenei _____	92
Canarie _____	28	Himalaya _____	202	Project _____	80
Cervino _____	168	Hot _____	186	Romance _____	114
Colorado _____	118	Il Giglio _____	8	Samoa _____	52
Darios _____	190	Junior _____	196	Spluga _____	126
Edera Plus _____	134	K2 _____	176	Stelvio _____	148
Elba _____	18	Kansas _____	100	Teide _____	164
Eros _____	70	Kent _____	84	Tonale _____	152
Everest _____	172	Lanzarote _____	14	Tonga _____	140
Febo _____	66	Lounge _____	46	Ventus _____	178
Felce _____	156	Maui _____	56	Vermont Pro _____	76
Ficus _____	184	Maine _____	106	Vesuvio _____	200
				Wizard _____	138

## SERIE DA APPOGGIO. TABLE TOP.

204

Afrodite _____	215	Giunone _____	214	Ninfea _____	251
Alexia _____	240	Glady _____	290	Petra _____	282
Altea _____	217	Helen _____	280	Petunia _____	242
Amelie _____	222	Idra _____	269	Polaris _____	208
Antares _____	264	Ilary _____	235	Primula _____	211
Aries _____	256	Irina _____	259	Pyxis _____	285
Astrid _____	225	Iside _____	253	Quadrotto _____	272
Azalea _____	239	Karima _____	243	Rainbow _____	266
Betty _____	210	Kira _____	277	Sabina _____	237
Bonnie _____	218	Kelly _____	244	Seventy _____	286
Brenda _____	283	Layla _____	278	Seventy Ekoplà _____	289
Calipso _____	213	Libra _____	255	Sharon _____	292
Catherine _____	229	Lounge _____	206	Silverino _____	295
Chanelle _____	262	Lucy _____	228	Sofia _____	254
Chantal _____	236	Lucrezia _____	223	Sole _____	274
Cixi _____	219	Marina _____	221	Spot _____	295
Clothilde _____	224	Marika _____	232	Thea _____	252
Corinne _____	248	Myosotis _____	220	Twist _____	260
Dafne _____	216	Moby _____	294	Vega _____	276
Dalia _____	241	Naomi _____	231	Verbena _____	246
Dori _____	284	Nemesia _____	209	Vivienne _____	234
Elettra _____	207	New Martina _____	230	Yvonne _____	279
Gemini _____	270	New Mizar _____	226	Wilma _____	238
Gioia _____	250	Nicole _____	247	Zoe _____	258
Giulia _____	268	Nigella _____	212		

## SPECCHI E ILLUMINAZIONE. MIRRORS AND LIGHTING.

296

• Specchi con luci - Mirrors with lights _____	298
• Specchi senza luci - Mirrors without lights _____	311
• Specchi contenitori e armadietti - Mirror cabinets _____	319
• Illuminazione - Lighting _____	322
• Specchi ingranditori - Magnifying mirrors _____	327

**ACCESSORI WC . WC ACCESSORIES .****3 3 2**

• Poubelles - Waste baskets _____	3 3 4
• Scopini wc da muro - Wall toilet brush holders _____	3 4 0
• Scopini wc - Toilet brush holders _____	3 4 5
• Sedili wc - Wc seats _____	3 6 0

**COMPLEMENTI D'ARREDO . FURNISHING ACCESSORIES .****3 6 6**

• Piantane - Towel stands _____	3 6 8
• Appendiabiti - Hooks _____	3 9 2
• Porta phon - Hairdryer supports _____	4 0 2
• Sgabelli - Stools _____	4 0 5
• Organizer - Organizers _____	4 1 0
• Portabiancheria - Laundry baskets _____	4 1 5
• Mensole - Shelves _____	4 1 8
• Bilance elettroniche - Electronic scales _____	4 1 9

**ACCESSORI DOCCIA . SHOWER ACCESSORIES .****4 2 0**

• Portaoggetti doccia - Shower caddies _____	4 2 2
• Tergivetro - Wiper blades _____	4 3 8
• Tappeti antiscivolo - Non slip mats _____	4 4 1
• Tappetini antiscivolo lavello - Sink-Mats _____	4 4 6
• Pedane doccia - Shower platforms _____	4 4 7
• Sedili per doccia e vasca - Shower and bath tub seats _____	4 4 8
• Tende doccia - Shower curtains _____	4 5 2
• Telai doccia - Shower rails _____	4 8 6

**TAPPETI DA BAGNO . BATH RUGS .****4 9 2****IDROTERAPIA . HYDROTHERAPY .****4 9 8**

• Doccette - Hand showers _____	5 0 0
• Duplex - Shower kits _____	5 1 2
• Set doccia - Shower sets _____	5 2 0
• Saliscendi - Shower slider rails _____	5 2 5
• Colonne doccia - Shower columns _____	5 3 1
• Pannelli doccia - Shower panels _____	5 4 1
• Soffioni - Shower heads _____	5 4 7
• Flessibili - Hoses _____	5 5 4
• Accessori - Accessories _____	5 5 7
• Idraulica - Taps accessories _____	5 6 6

**CONTRACT .****5 6 8**

• Distributori di sapone e gel igienizzante - Dispensers for soap and sanitizer gel _____	5 7 0
• Phon con supporto a parete - Hair dryers with wall support _____	5 7 9
• Asciugamani elettrici - Air hand dryers _____	5 8 0
• Distributori di carta - Paper towel dispensers _____	5 8 3
• Materiali di consumo - Refills _____	5 9 0
• Filo stendibiancheria riavvolgibile - Retractable clothes line _____	5 9 1
• Mesole porta asciugamani - Shelves for towels _____	5 9 1
• Maniglioni - Grab bars _____	5 9 5
• Project _____	6 0 0
• Prima Classe _____	6 0 4
• Sicura _____	6 1 0
• Fortis _____	6 1 4
• Friend _____	6 1 7

**BAMBOOM . ЕКОПЛА .****6 1 8**

**ATTENZIONE: le quote sono puramente indicative, NON considerarle per l'esecuzione delle forature.**

ATTENTION: measurements are indicative. DO NOT use them to drill holes.

ATTENTION: les cotes sont fournies à titre indicatif, NE PAS en tenir compte pour la réalisation des perçages.

ACHTUNG: die Quoten dienen als Anhaltspunkte; sie NICHT zur Ausführung der Bohrungen heranziehen!

ATENCIÓN: las medidas son indicativas, NO tenerlas en cuenta para realizar los orificios.

ВНИМАНИЕ: измерения являются ориентировочными. НЕ используйте их для сверления отверстий.

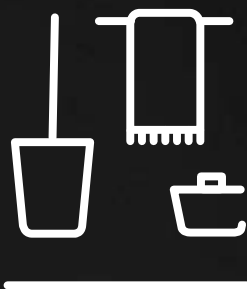

SERIE  
DA MURO  
Wall lines



# Il Giglio.

design Makio Hasuike\*



**Realizzata in ottone, acciaio inox AISI 304 e Cromall® con contenitori in vetro satinato**

Made of brass, AISI 304 stainless steel and Cromall® with frosted glass containers

Réalisée en laiton, acier inoxydable AISI 304 et Cromall® avec boîtiers en verre satiné

Hergestellt aus Messing, Edelstahl AISI 304 und Cromall® mit Behältern aus satiniertem Glas

Realizada en latón, acero inox AISI 304 y Cromall® con contenedores en cristal satinado

Изготовлено из латуни, нержавеющей стали AISI 304 и Cromall® с ёмкостями из матового стекла



Con viti  
With screws



GARANZIA  
WARRANTY



MADE  
in Italy

esclusi prodotti con \*\*  
excluding items with \*\*



13  
Cromato  
Chromed

esclusi prodotti con \*  
excluding items with \*



# Il Giglio.

SERIE DA MURO  
Wall series



SERIE DA MURO . WALL LINES .

TOP DESIGN

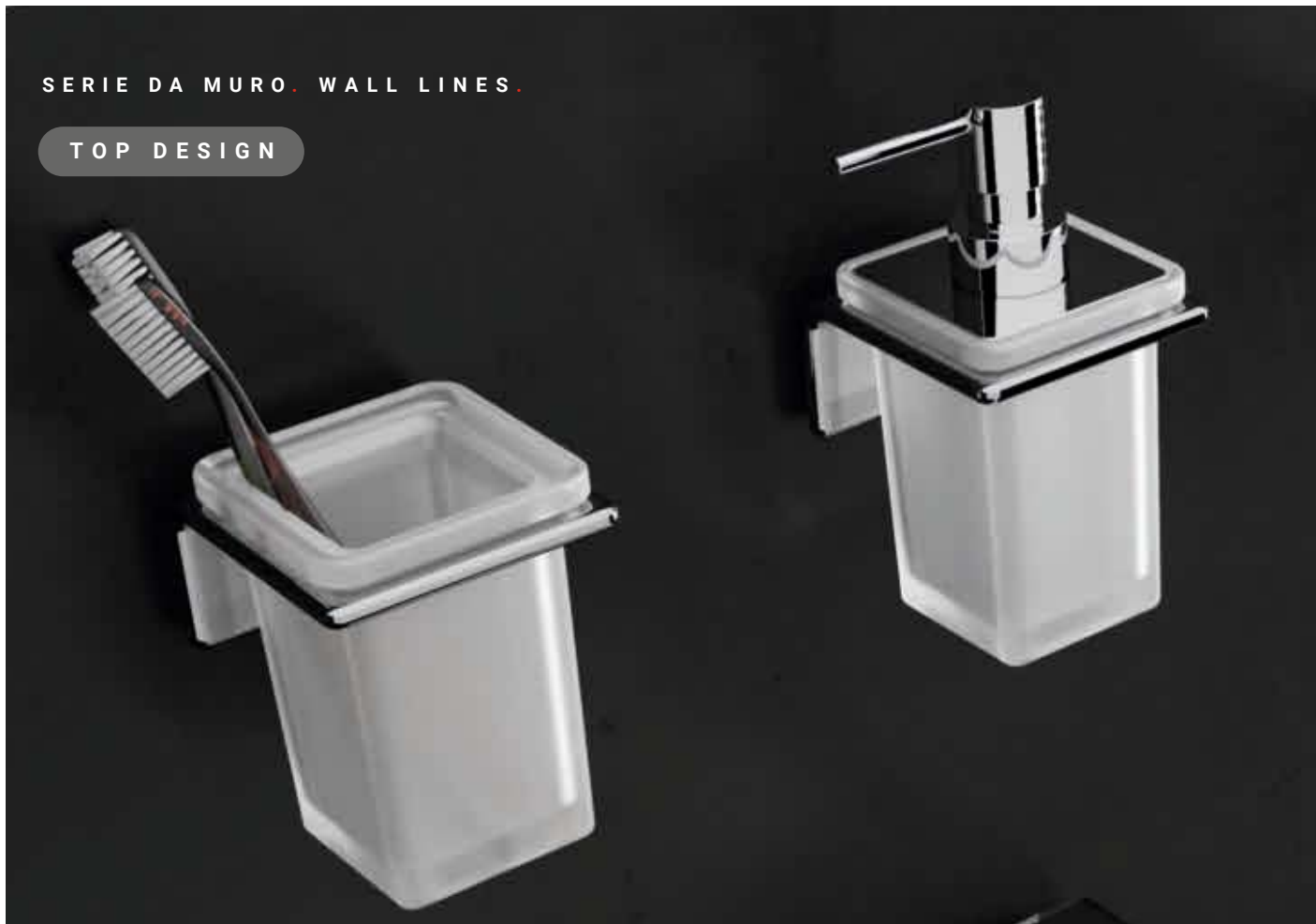

# Il Giglio.

SERIE DA MURO  
Wall series

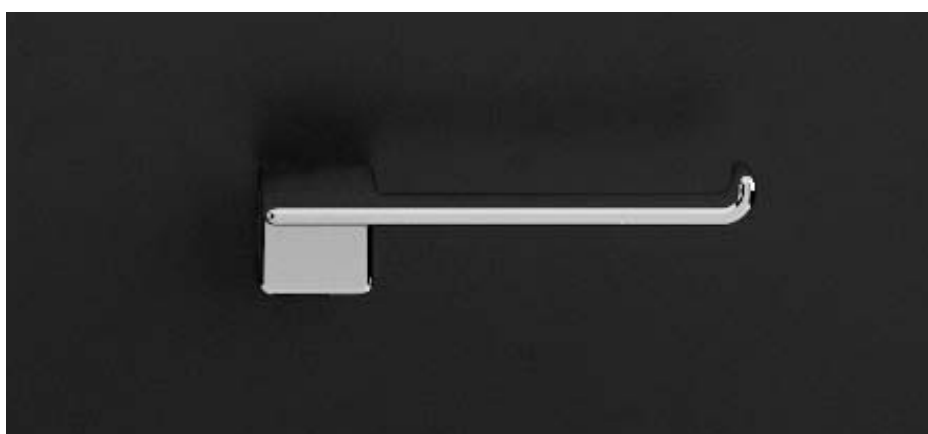

SERIE DA MURO . WALL LINES .

TOP DESIGN



A910

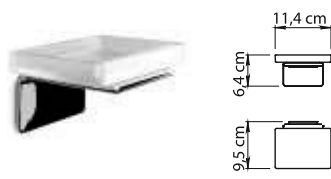

A911

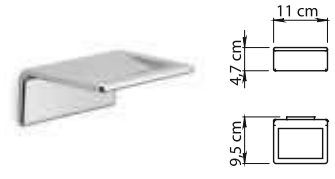

A912



A981

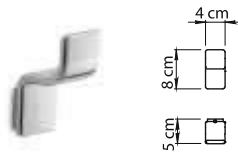

A926

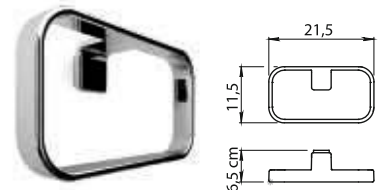

A970



A921-35



A921-45



A921-60



A923



A924

# Il Giglio.

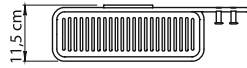
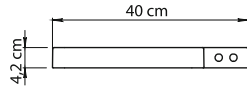

**A918\*\***

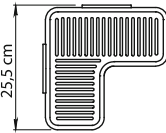
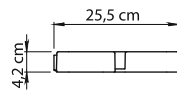

**A983\*\***

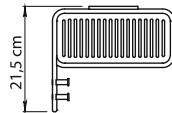
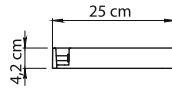

**A919\*\***



**Ottone e alluminio**  
Brass and aluminium  
Laiton et aluminium  
Messing und Aluminium  
Latón y aluminio  
Латуни и алюминия

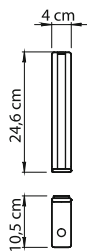
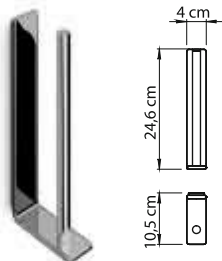

**A924-02**

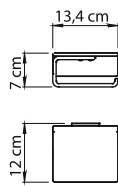

**A925**

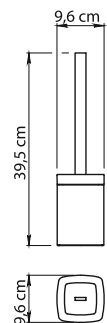

**A933\*\***

## Lanzarote.

**Realizzata in ottone e Cromall® con contenitori in vetro satinato**

Made of brass and Cromall® with frosted glass containers

Réalisée en laiton et Cromall® avec boîtiers en verre satiné

Hergestellt aus Messing und Cromall® mit Behältern aus satiniertem Glas

Realizada en latón y Cromall® con contenedores en cristal satinado

Изготовлено из латуни и Cromall® с ёмкостями из матового стекла



Con viti

With screws



GARANZIA

WARRANTY



13

Cromato  
Chromed

Lanzarote.

SERIE DA MURO  
Wall series



SERIE DA MURO . WALL LINES .

TOP DESIGN

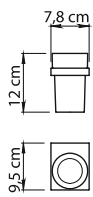
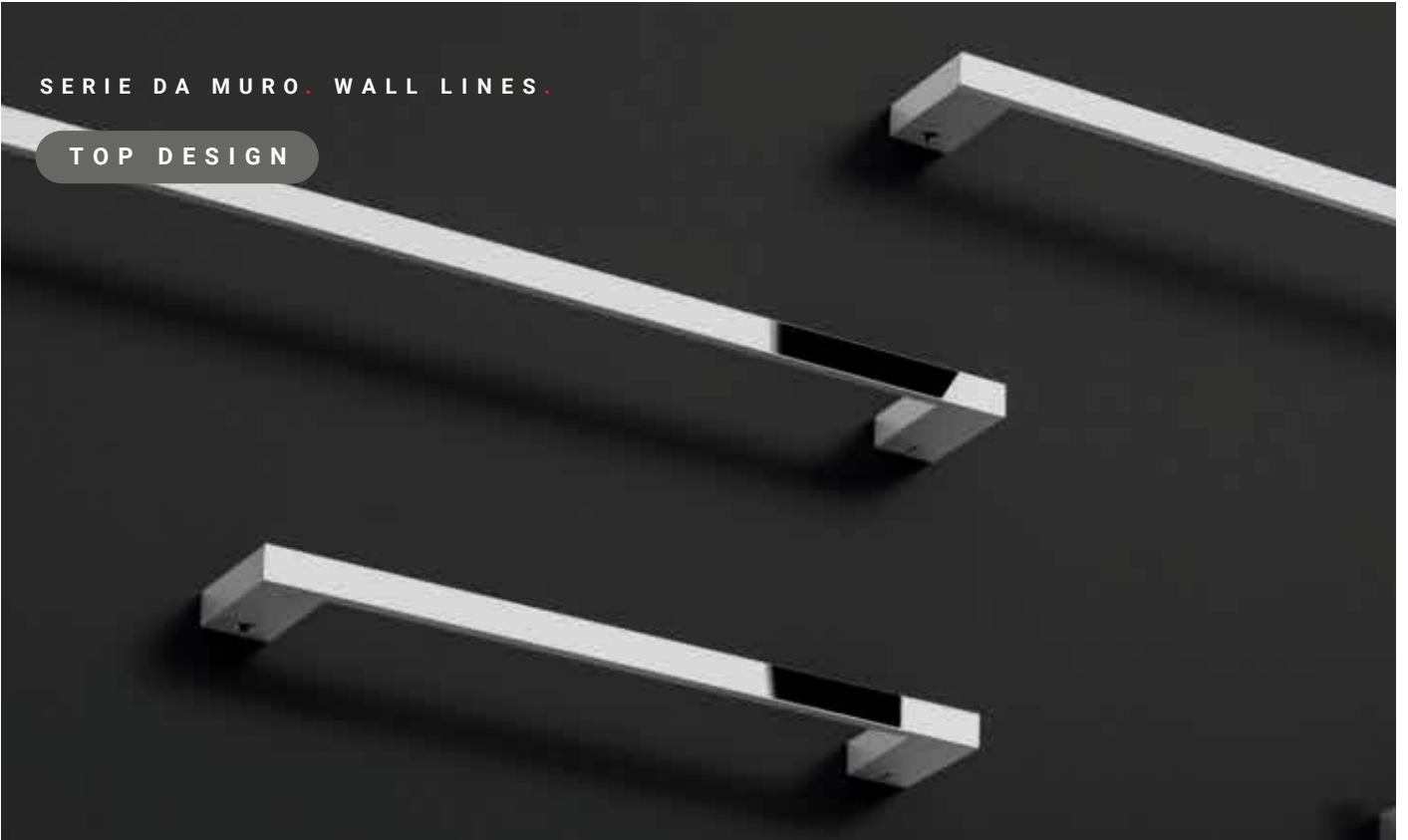

A310

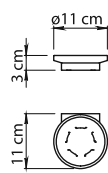

A311

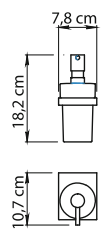

A381



# Lanzarote.

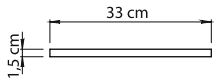

**A321-30**

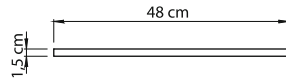

**A321-45**

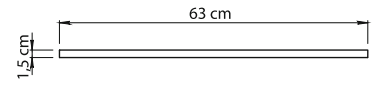

**A321-60**

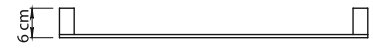

**A370**

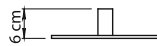
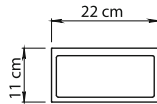

**A323**

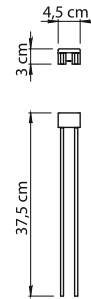

**A324**

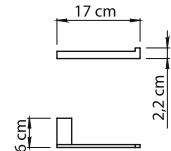

**A326**

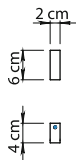

**A325**

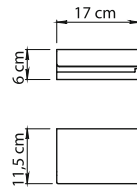

**A329**

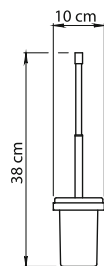
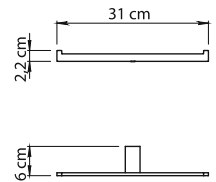

**A333-03**

**Manico telescopico**  
Telescopic handle  
Manche télescopique  
Ausziehbarer Stiel  
Mango telescópico  
Телескопической ручкой



**Elba.**

**Realizzata in ottone, alluminio e Cromall® con contenitori in vetro satinato**

Made of brass, aluminium and Cromall® with frosted glass containers

Réalisée en laiton, aluminium et Cromall® avec boîtiers en verre satiné

Hergestellt aus Messing, Aluminium und Cromall® mit Behältern aus satiniertem Glas

Realizada en latón, aluminio y Cromall® con contenedores en cristal satinado

Изготовлено из латуни, алюминия и Cromall® с ёмкостями из матового стекла



Con viti

With screws



Con colla

With glue

(Venduta a parte  
Sold seperately)



GARANZIA

WARRANTY



13

Cromato  
Chromed

Elba.

SERIE DA MURO  
Wall series

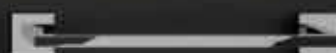
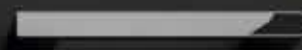

SERIE DA MURO . WALL LINES .

TOP DESIGN



**Elba.**

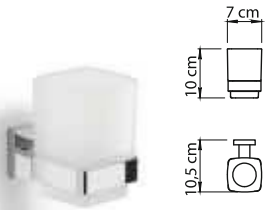

**A010**

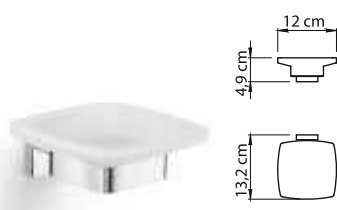

**A011**

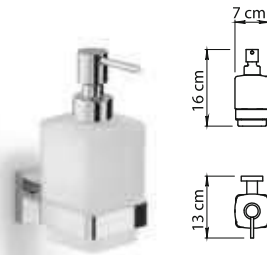

**A081**

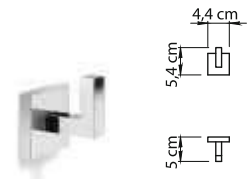

**A026**



**A021-30**



**A021-45**



**A021-60**



**A070**

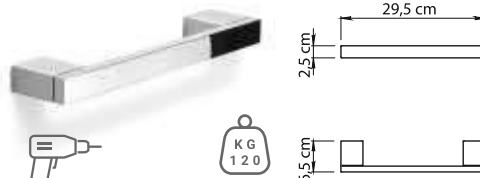

Solo con viti  
Only with screws **A021-28**

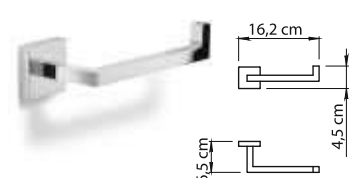

**A024**



**A022**

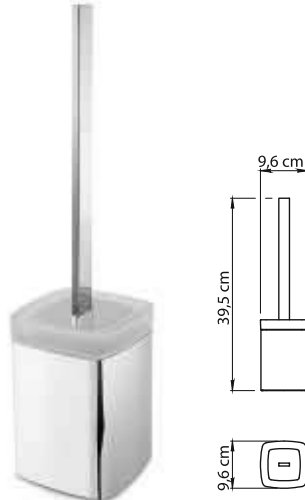

**A033**

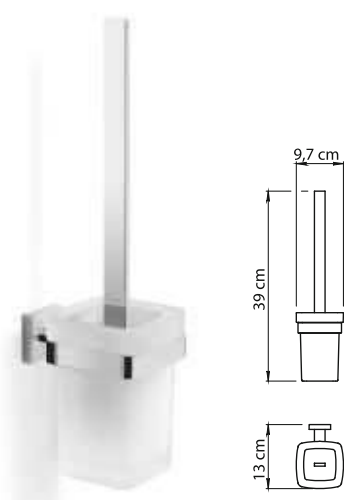

**A033-03**

## Azzorre.

**Realizzata in alluminio, ottone e Cromall® con contenitori in vetro satinato**

Made of aluminium, brass and Cromall® with frosted glass containers

Réalisée en aluminium, laiton et Cromall® avec boîtiers en verre satiné

Hergestellt aus Aluminium, Messing und Cromall® mit Behältern aus satiniertem Glas

Realizada en aluminio, latón y Cromall® con contenedores en cristal satinado

Изготовлено из алюминия, латуни и Cromall® с ёмкостями из матового стекла



Con viti

With screws



GARANZIA

WARRANTY



13

Cromato  
Chromed

Azzorre.

SERIE DA MURO  
Wall series



SERIE DA MURO . WALL LINES .

TOP DESIGN







Azzorre.

SERIE DA MURO  
Wall series

SERIE DA MURO . WALL LINES .

TOP DESIGN



A110

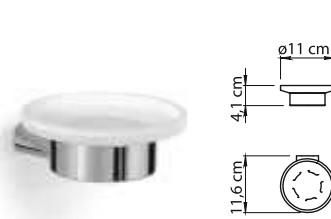

A111



A181



A121-30



A121-45



A121-60



A170



A123

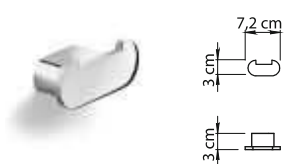

A126



A124



A125

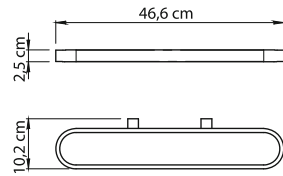

**A147**

**Accessori venduti separatamente**

Accessoires supplied separately



S2

Satinato  
Satinized

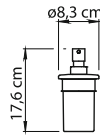
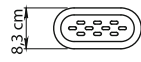
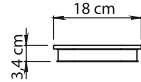
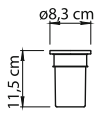

**A198**



**A151**



**A155**

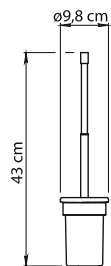

**A133-03**

**Manico telescopico**

Telescopic handle  
Manche télescopique  
Ausziehbares Stiel  
Mango telescópico  
Телескопической ручкой

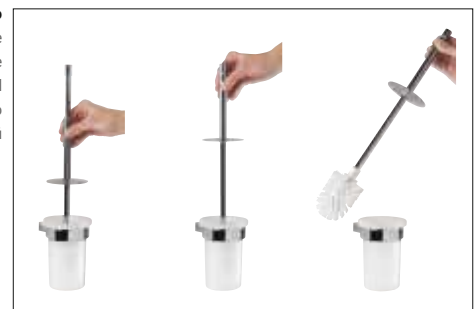

## Canarie.

**Realizzata in ottone e Cromall® con contenitori in vetro satinato**

Made of brass and Cromall® with frosted glass containers

Réalisée en laiton et Cromall® avec boîtiers en verre satiné

Hergestellt aus Messing und Cromall® mit Behältern aus satiniertem Glas

Realizada en latón y Cromall® con contenedores en cristal satinado

Изготовлено из латуни и Cromall® с ёмкостями из матового стекла



Con viti

With screws



GARANZIA

WARRANTY



13

Cromato  
Chromed

Canarie.

SERIE DA MURO  
Wall series

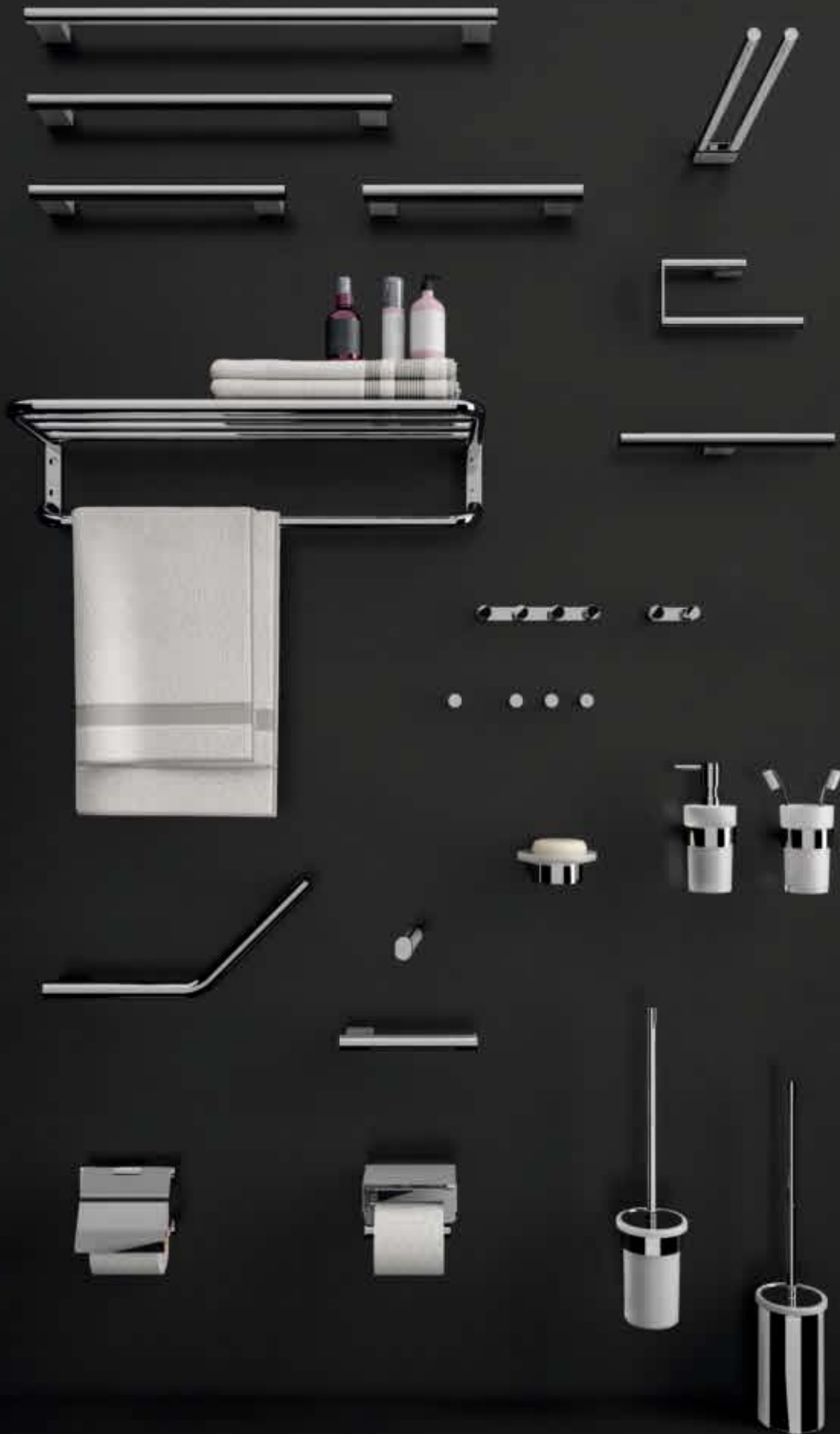

SERIE DA MURO . WALL LINES .

TOP DESIGN



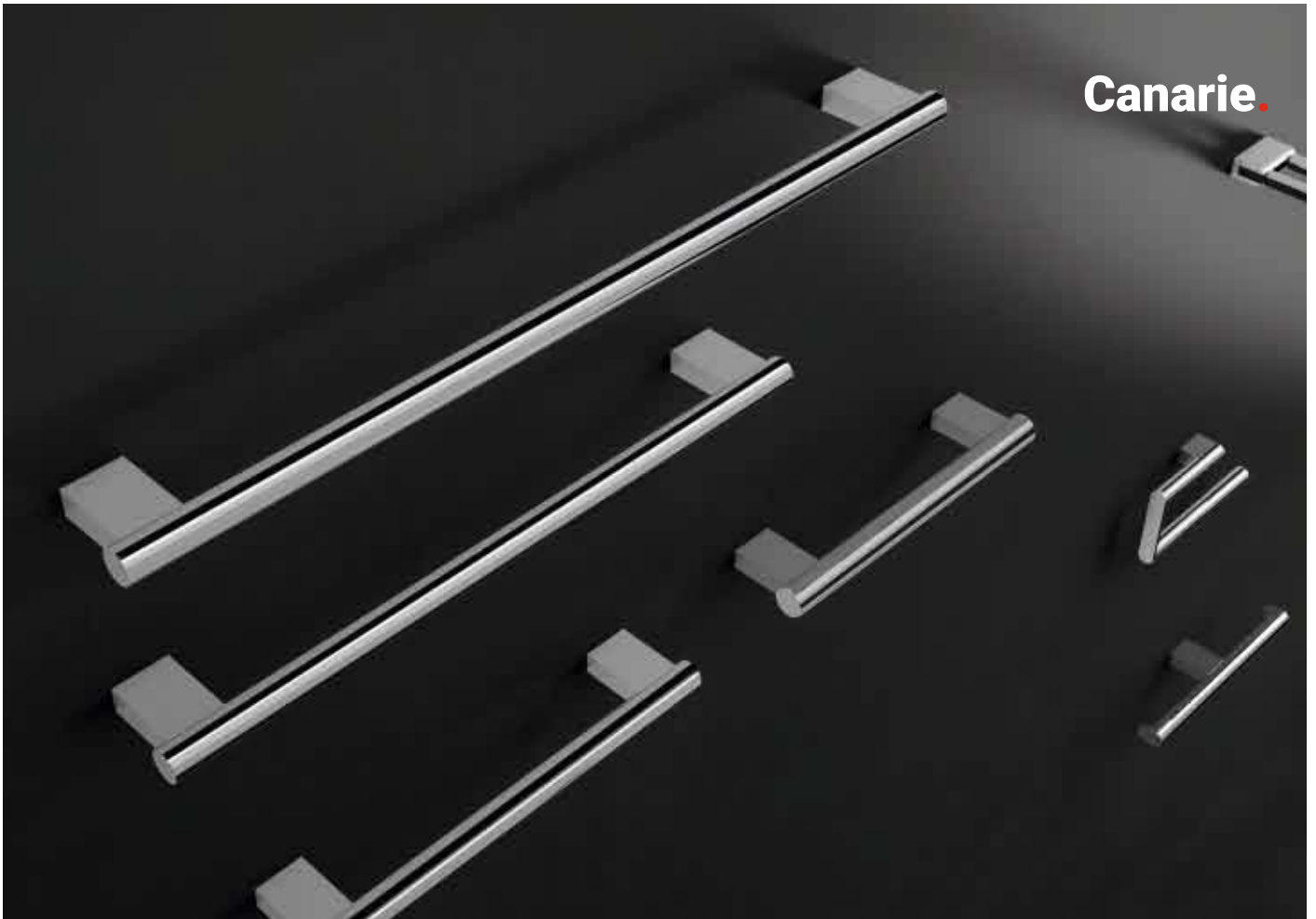

A210



A211



A281

AISI  
304



A221-30



A221-45



A221-60

SERIE DA MURO . WALL LINES .

TOP DESIGN

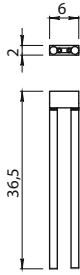

A223

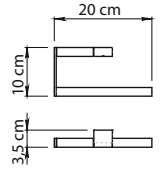

A270

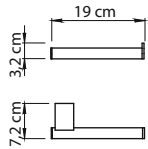

A224

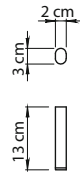

A224-02

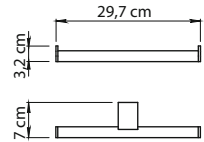

A229

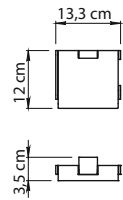

A225

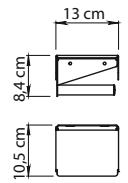

A225-01

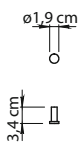

A227

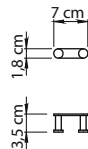

A226

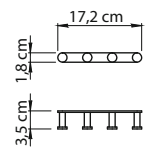

A228



# Canarie.

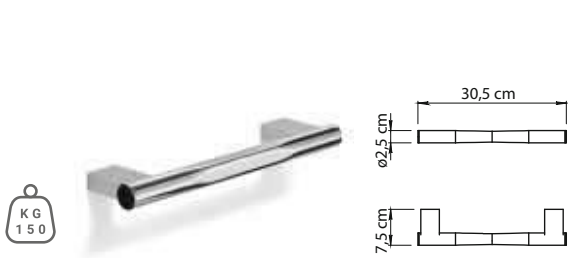

**A221-28**

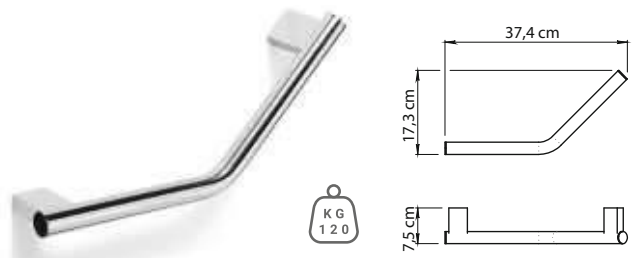

**A222**



**A235**

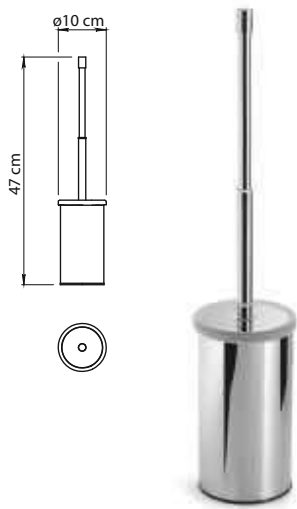
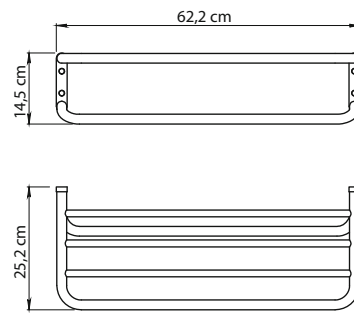

**Acciaio inox**  
Stainless steel  
Acier inoxydable  
Edelstahl  
Acero inox  
Нержавеющая сталь

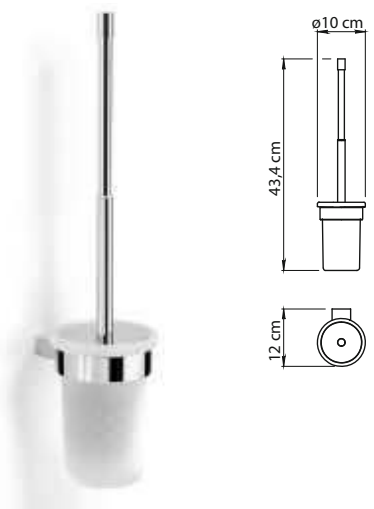

**Manico telescopico**  
Telescopic handle  
Manche télescopique  
Ausziehbarer Stiel  
Mango telescópico  
Телескопической ручкой



**A233**



**A233-03**

## Outline.

design Simone Micheli

**Realizzata in ottone, acciaio inox e Cromall®**

Made of brass, stainless steel and Cromall®

Réalisée en laiton, acier inoxydable et Cromall®

Hergestellt aus Messing, Edelstahl und Cromall®

Realizada en latón, acero inox y Cromall®

Изготовлено из латуни, нержавеющей стали и Cromall®



Con viti  
With screws



GARANZIA  
WARRANTY



13  
**Cromato**  
Chromed



14  
**Nero matt**  
Matt black



22  
**Bianco matt**  
Matt white

Outline.

SERIE DA MURO  
Wall series



SERIE DA MURO . WALL LINES .

TOP DESIGN





SERIE DA MURO. WALL LINES.

TOP DESIGN

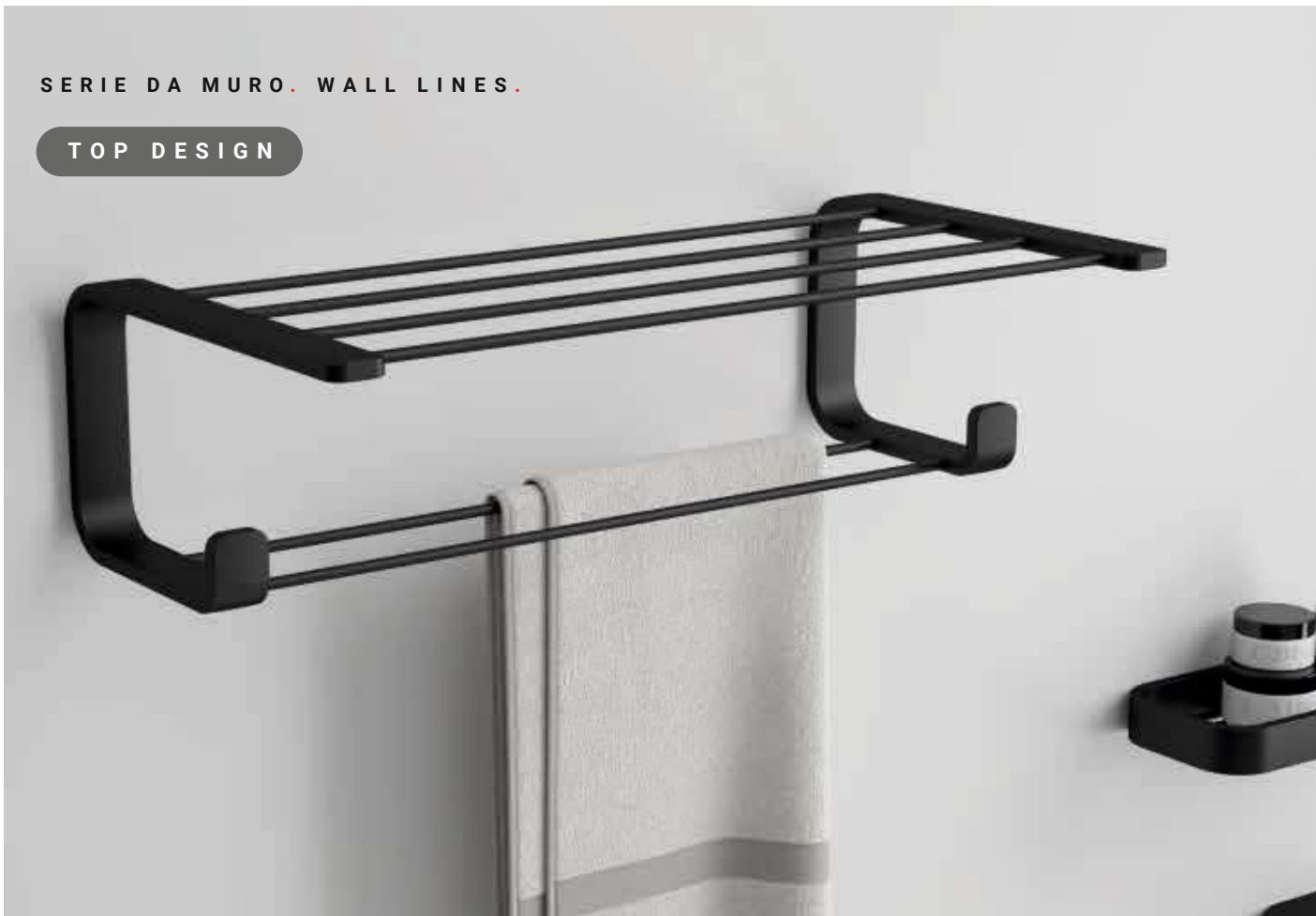

# Outline.

SERIE DA MURO  
Wall series



SERIE DA MURO . WALL LINES .

TOP DESIGN

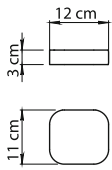

3212

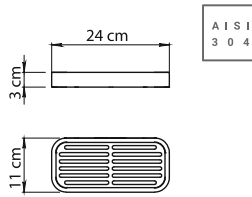

3218

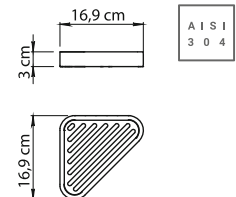

3283

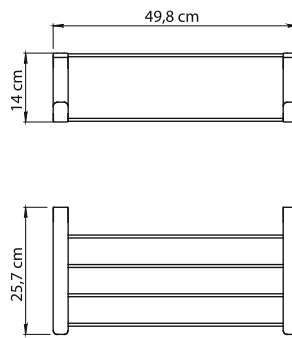

3235

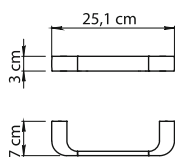

3221-25

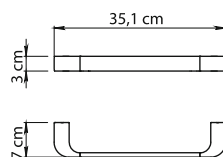

3221-35

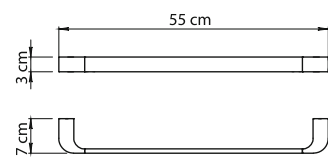

3221-55



# Outline.

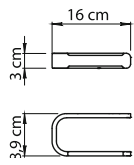

**3224**

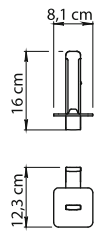

**3224-02**

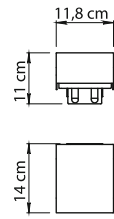

**3225**

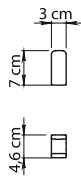

**3226**

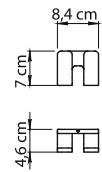

**3228**

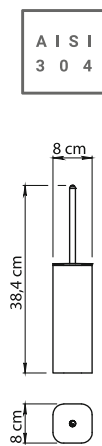

**3234**

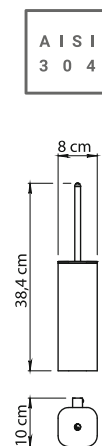

**3233-03**

SERIE DA MURO . WALL LINES .

TOP DESIGN

**Gea.**

**Realizzata in ottone e alluminio con contenitori in vetro satinato**

Made of brass and aluminium with frosted glass containers

Réalisée en laiton et aluminium avec boîtiers en verre satiné

Hergestellt aus Messing und Aluminium mit Behältern aus satiniertem Glas

Realizada en latón y aluminio con contenedores en cristal satinado

Изготовлено из латуни и алюминия с ёмкостями из матового стекла



Con biadesivo

With double sided tape



GARANZIA

WARRANTY



13  
Cromato  
Chromed

Gea.

SERIE DA MURO  
Wall series

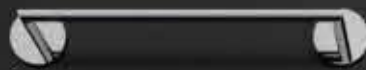

SERIE DA MURO . WALL LINES .

TOP DESIGN

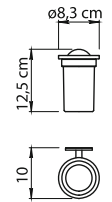
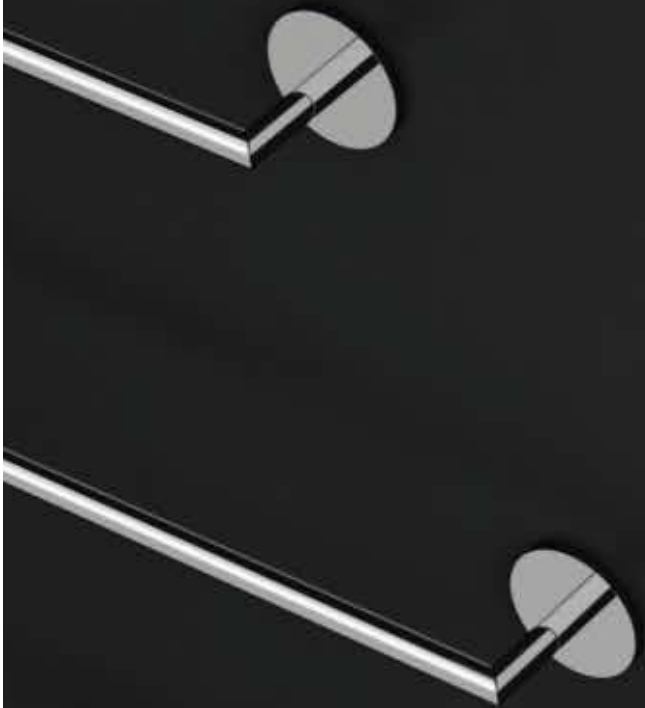

3610

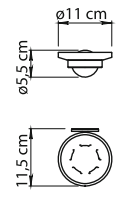

3611

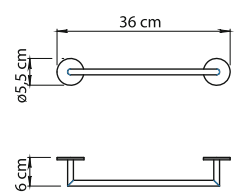

3621-35

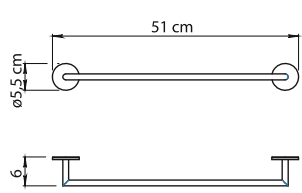

3621-50

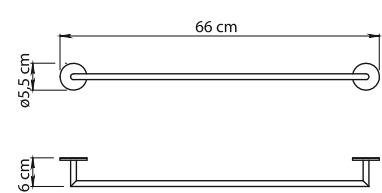

3621-65

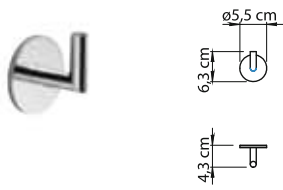

**3626**

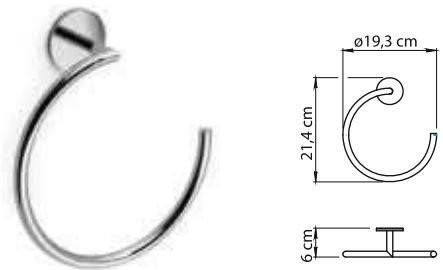

**3670**

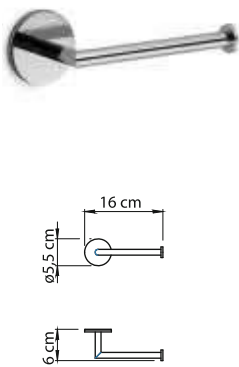

**3624**



**3625**

## Lounge.

**Realizzata in alluminio e Cromall® con contenitori in vetro satinato**

Made of aluminium and Cromall® with frosted glass containers

Réalisée en aluminium et Cromall® avec boîtiers en verre satiné

Hergestellt aus Aluminium und Cromall® mit Behältern aus satiniertem Glas

Realizada en aluminio y Cromall® con contenedores en cristal satinado

Изготовлено из латуни и ёмкостями с Cromall® из матового стекла



Con viti

With screws



GARANZIA

WARRANTY



13  
Cromato  
Chromed



14  
Nero matt  
Matt black

# Lounge.

SERIE DA MURO  
Wall series



SERIE DA MURO . WALL LINES .

TOP DESIGN



5410



5411



5481

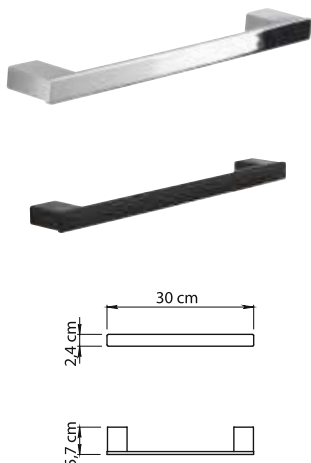

5421-30

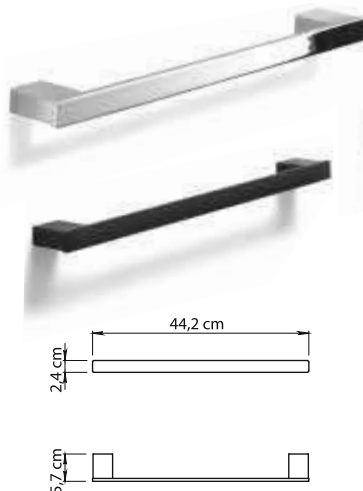

5421-45

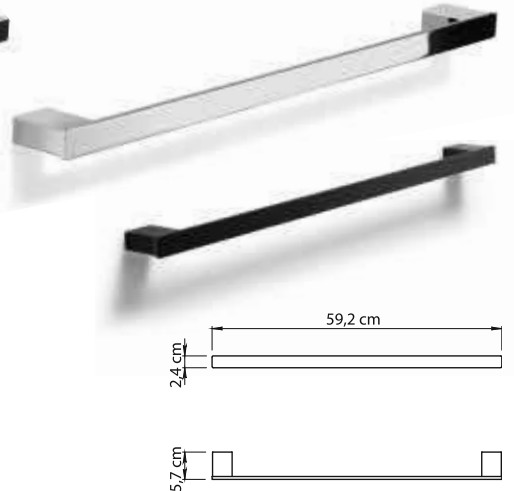

5421-60





TOP DESIGN

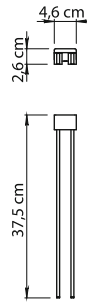

5423

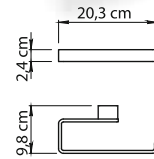
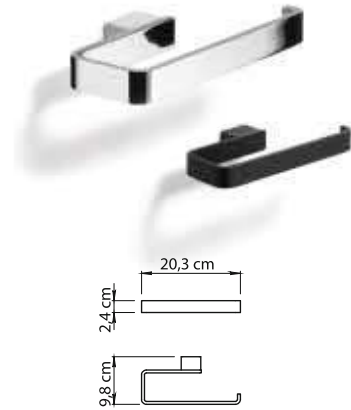

5470

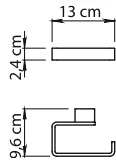

5424

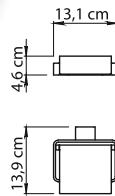

5425

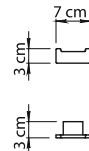

5426

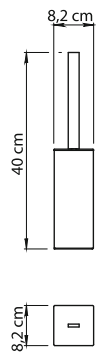

5433

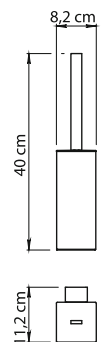

5433-03

# Lounge.

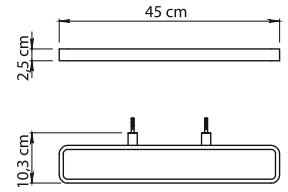

**Accessori venduti separatamente**

Accessoires supplied separately

**5447**



**S2**  
**Satinato**  
Satinized



**S2**  
**Satinato/cromato**  
Satinized/chromed



**SN**  
**Satinato/nero**  
Satinized/black

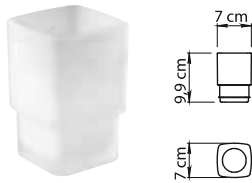

**5498**

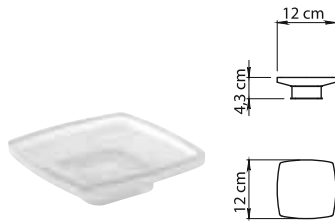

**5451**



**5455**



**13**  
**Cromato**  
Chromed



**14**  
**Nero matt**  
Matt black



**5498**



**5451**



**5455**

# Samoa.

design Piet Billekens

**Realizzata in ottone e Cromall® con contenitori in vetro satinato**

Made of brass and Cromall® with frosted glass containers

Réalisée en laiton et Cromall® avec boîtiers en verre satiné

Hergestellt aus Messing und Cromall® mit Behältern aus satiniertem Glas

Realizada en latón y Cromall® con contenedores en cristal satinado

Изготовлено из латуни и Cromall® с ёмкостями из матового стекла



Con viti

With screws



GARANZIA

WARRANTY



13

**Cromato**  
Chromed



14

**Nero matt**  
Matt black

Samoa.

SERIE DA MURO  
Wall series



SERIE DA MURO . WALL LINES .

TOP DESIGN

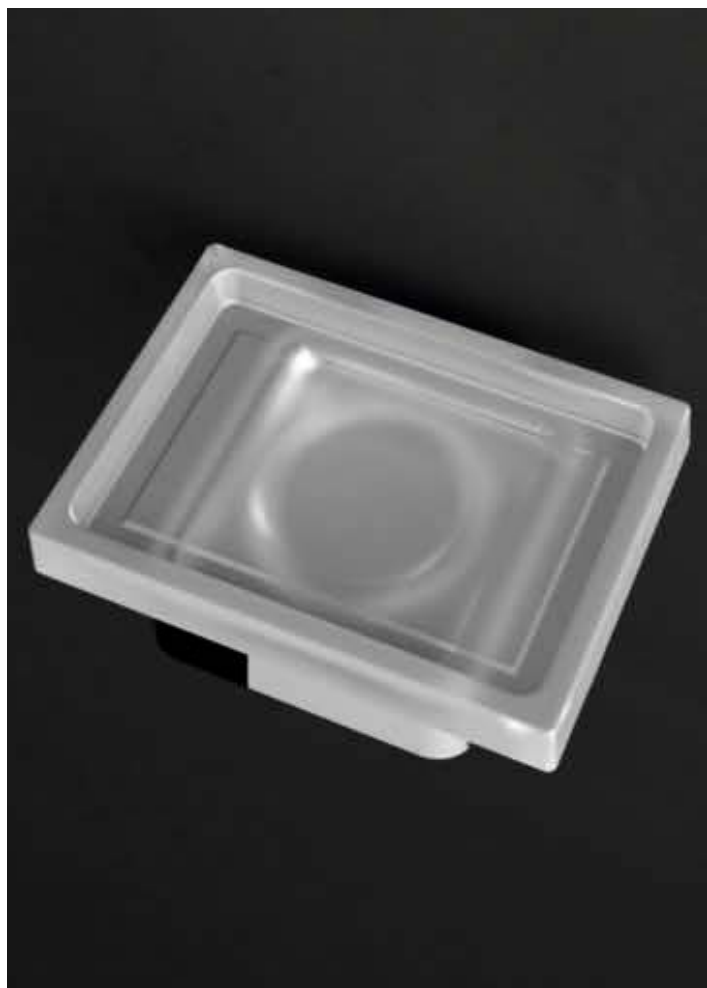

# Samoa.

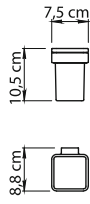

**A810**

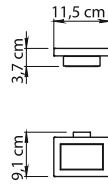

**A811**

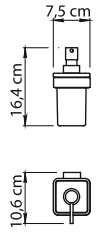

**A881**

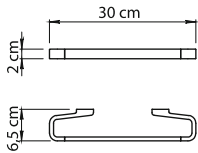

**A821-30**

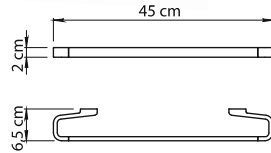

**A821-45**

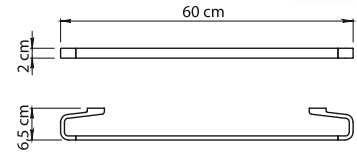

**A821-60**

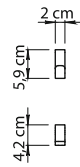

**A827**

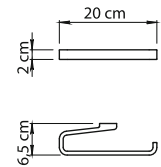

**A870**

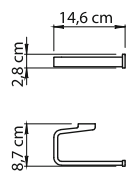

**A824**

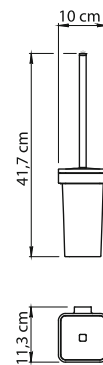

**A833-03**

## Maui.



**Realizzata in acciaio inox AISI 304 e Cromall® con contenitori in vetro satinato**

Made of AISI 304 stainless steel and Cromall® with frosted glass containers

Réalisée en acier inoxydable AISI 304 et Cromall® avec boîtiers en verre satiné

Hergestellt aus Edelstahl AISI 304 und Cromall® mit Behältern aus satiniertem Glas

Realizada en acero inox AISI 304 y Cromall® con contenedores en cristal satinado

Изготовлено из нержавеющей стали AISI 304 и Cromall® с ёмкостями из матового стекла



Con viti  
With screws



GARANZIA  
WARRANTY



38  
Spazzolato  
Brushed



Maui.



SERIE DA MURO . WALL LINES .

TOP DESIGN

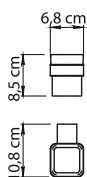

A510

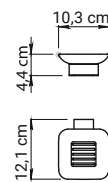

A511

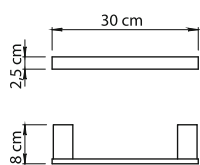

A521-30

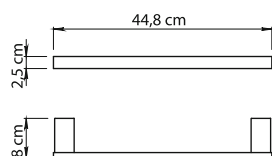

A521-45

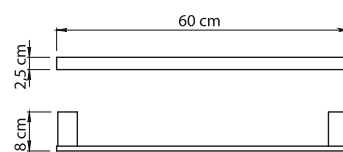

A521-60

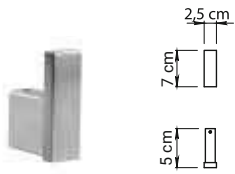

**A526**



**A570**



**A524**

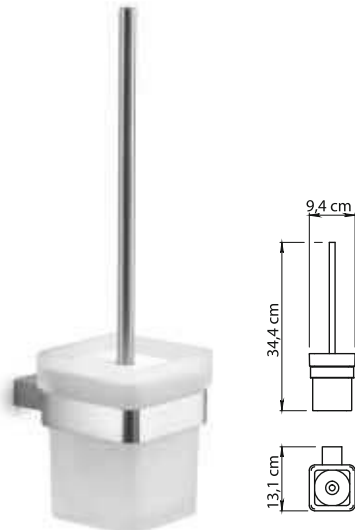

**A533-03**

SERIE DA MURO . WALL LINES .

TOP DESIGN

# Bridge.

design Carlo Martino

**Realizzata in ottone, acciaio inox e Cromall®**

Made of brass, stainless steel and Cromall®

Réalisée en laiton, acier inoxydable et Cromall®

Hergestellt aus Messing, Edelstahl und Cromall®

Realizada en latón, acero inox y Cromall®

Изготовлено из латуни, нержавеющей стали, Cromall® и матового стекла



Con viti  
With screws



GARANZIA  
WARRANTY



13  
Cromato  
Chromed

# Bridge.

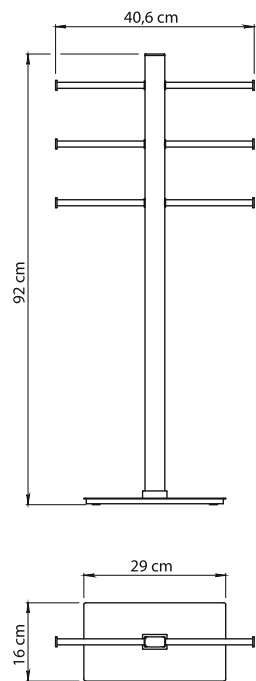
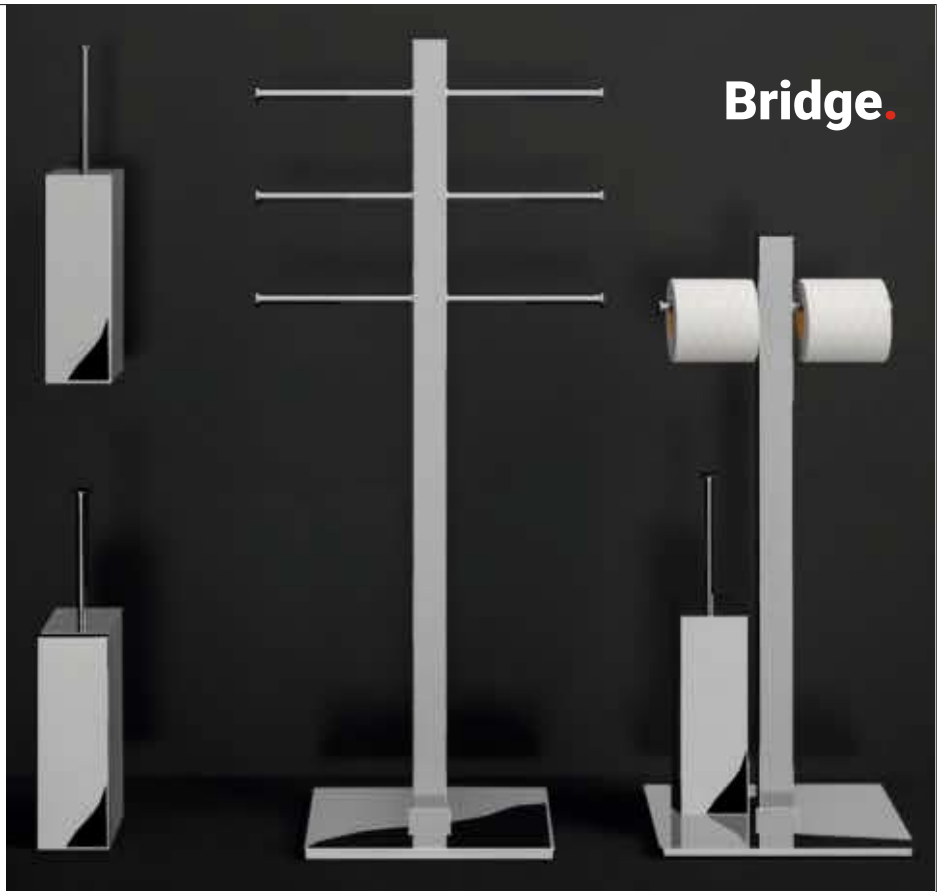

**7631**

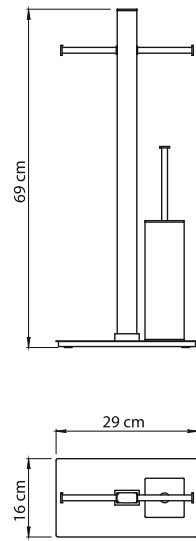

**7632**

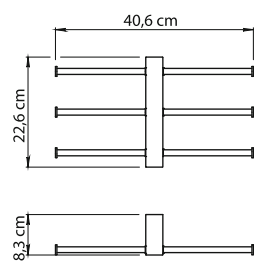

**7630**

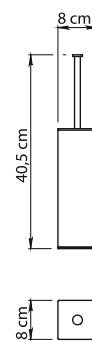

**7633**

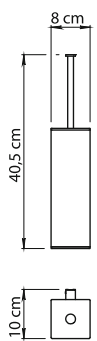

**7633-03**

RETAIL

## Atena.

### Realizzata in acciaio inox e Cromall® con contenitori in vetro satinato

Made of stainless steel and Cromall® with frosted glass containers

Réalisée en acier inoxydable et Cromall® avec boîtiers en verre satiné

Hergestellt aus Edelstahl und Cromall® mit Behältern aus satiniertem Glas

Realizada en acero inoxidable y Cromall® con contenedores en cristal satinado

Изготовлено из нержавеющей стали и Cromall® с ёмкостями из матового

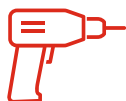

Con viti

With screws



Con colla

With glue

(Venduta a parte  
Sold seperately)



GARANZIA

WARRANTY



13  
Cromato  
Chromed



14  
Nero matt  
Matt black

**Atena.**

SERIE DA MURO  
Wall series



SERIE DA MURO. WALL LINES.

RETAIL

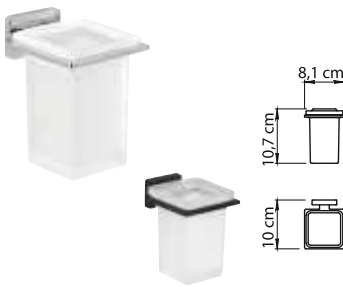
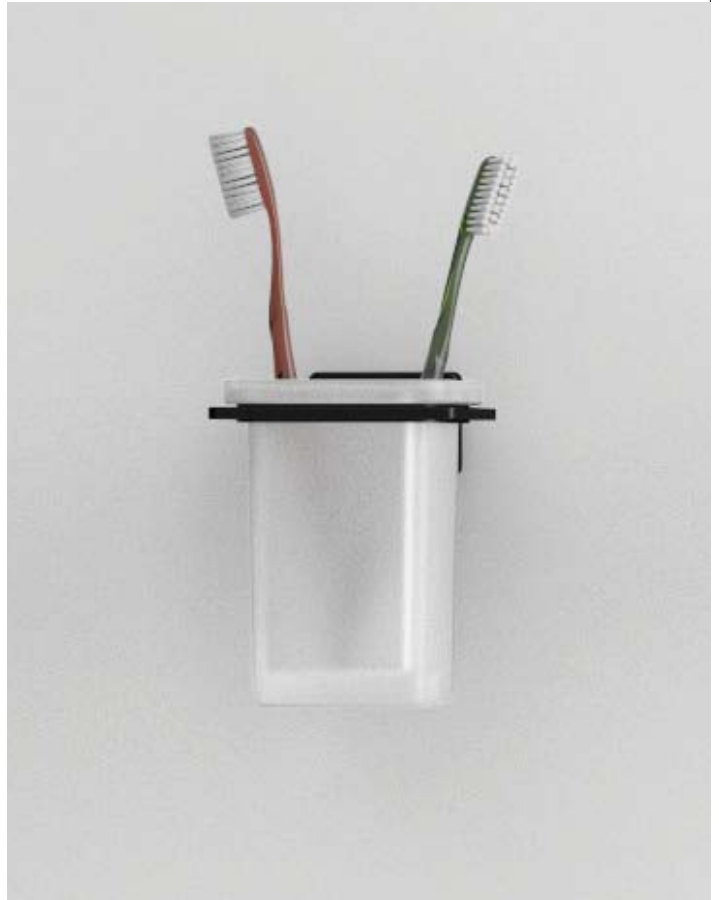

4410

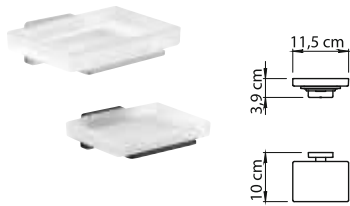

4411

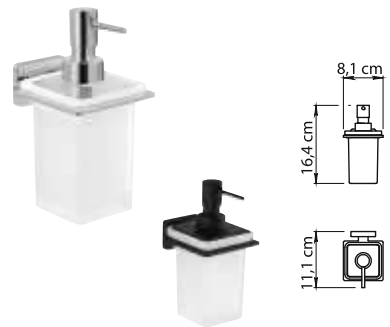

4481



# Atena.

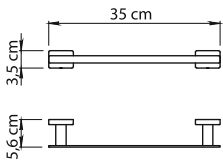
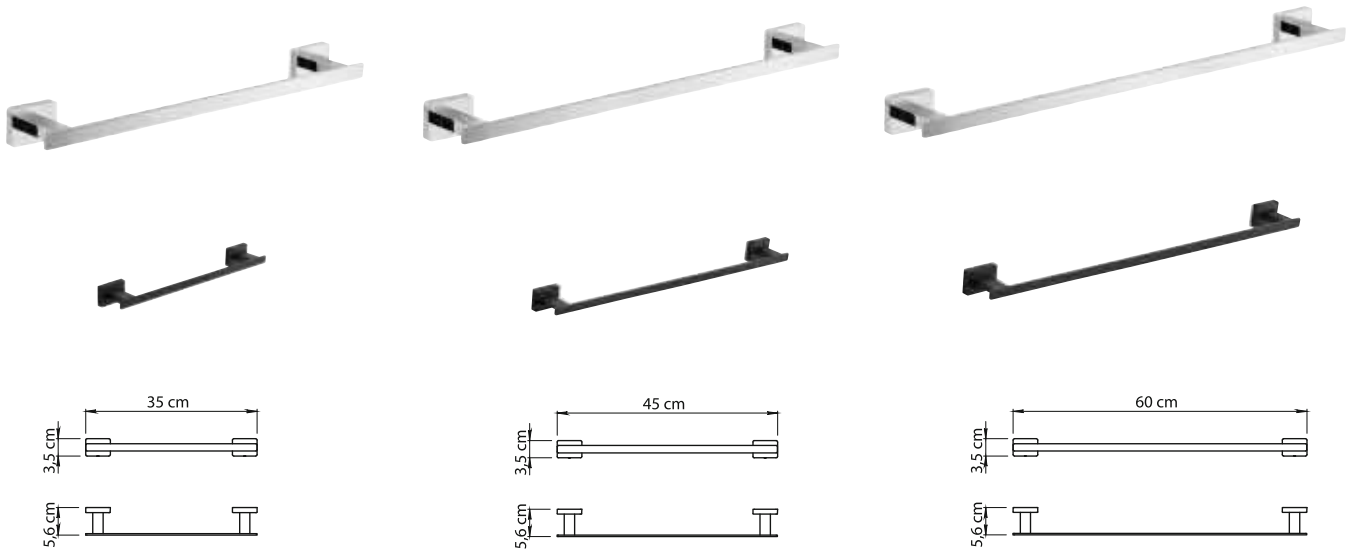

**4421-30**

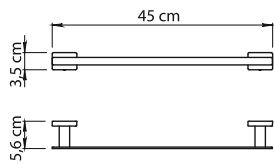

**4421-45**

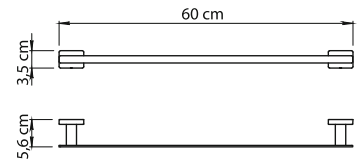

**4421-60**

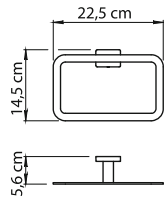
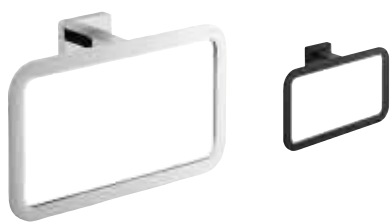

**4470**

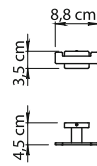

**4426**

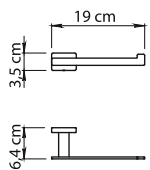
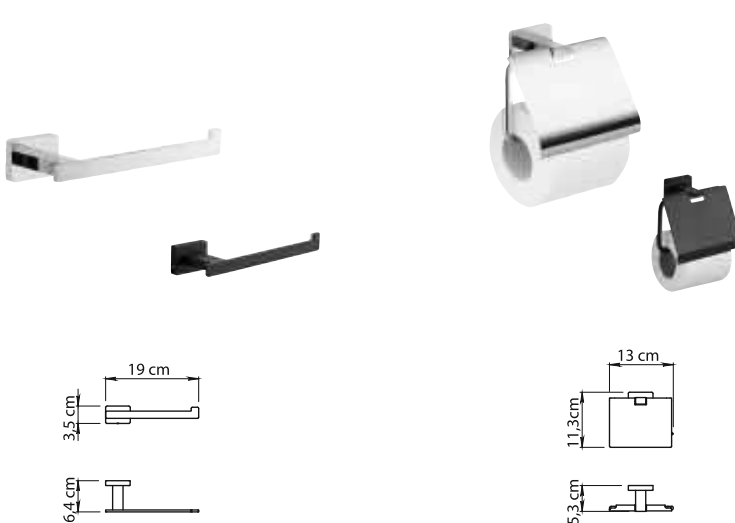

**4424**

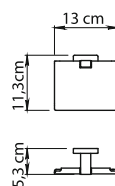

**4425**

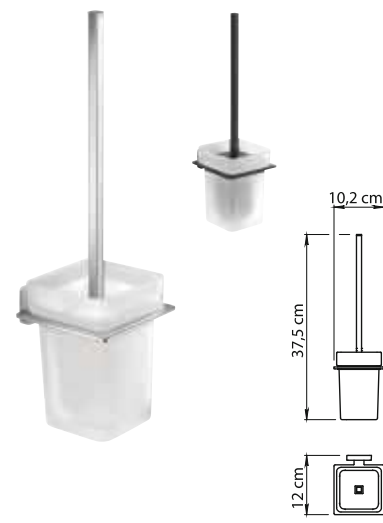

**4433-03**

RETAIL

## Febo.

### Realizzata in acciaio inox e Cromall® con contenitori in vetro satinato

Made of stainless steel and Cromall® with frosted glass containers

Réalisée en acier inoxydable et Cromall® avec boîtiers en verre satiné

Hergestellt aus Edelstahl und Cromall® mit Behältern aus satiniertem Glas

Realizada en acero inoxidable y Cromall® con contenedores en cristal satinado

Изготовлено из нержавеющей стали и Cromall® с ёмкостями из матового стекла

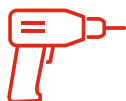

Con viti

With screws



Con colla

With glue



GARANZIA

WARRANTY

(Venduta a parte  
Sold seperately)



13

Cromato  
Chromed

Febo.

SERIE DA MURO  
Wall series



SERIE DA MURO. WALL LINES.

RETAIL

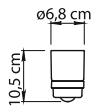

5310

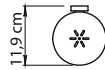
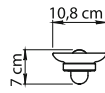

5311

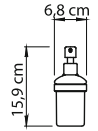

5381

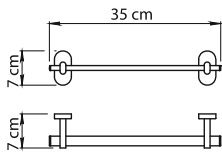

5321-35

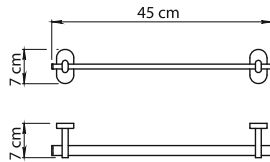

5321-45

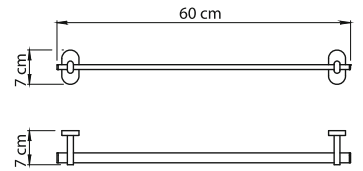

5321-60



Solo con viti  
Only with screws



5323

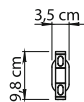

5370

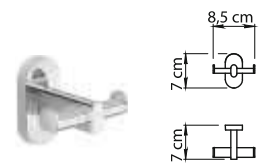
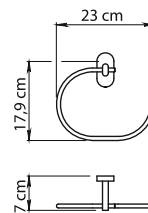

5326

**Febo.**

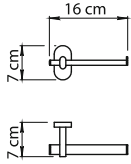

**5324**

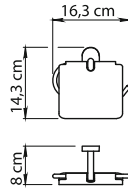

**5325**

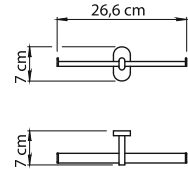

**5329**



Vetro temperato  
Tempered glass



Solo con viti  
Only with screws

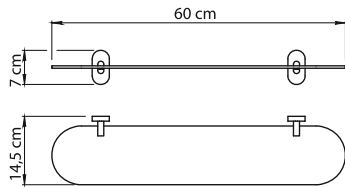

**5319-60**

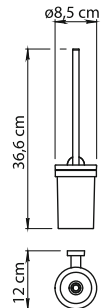
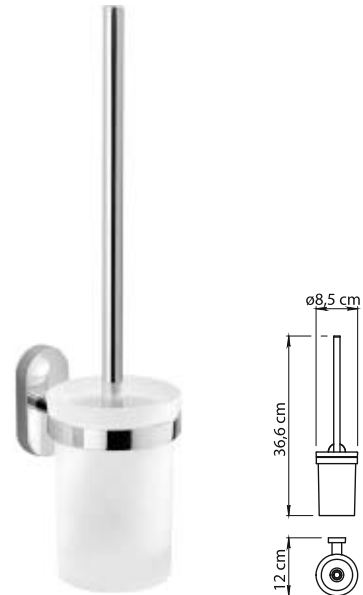

**5333-03**

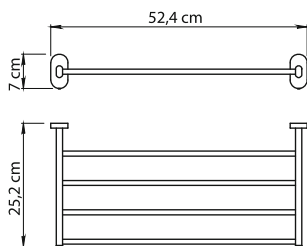

**5344**

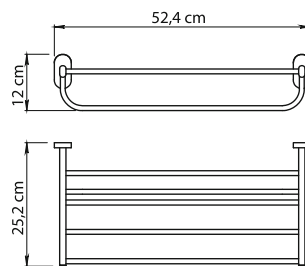
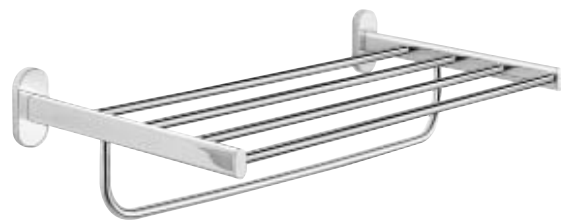

**5335**



Solo con viti  
Only with screws

RETAIL

## Eros.

### Realizzata in acciaio inox e Cromall® con contenitori in vetro satinato

Made of stainless steel and Cromall® with frosted glass containers

Réalisée en acier inoxydable et Cromall® avec boîtiers en verre satiné

Hergestellt aus Edelstahl und Cromall® mit Behältern aus satiniertem Glas

Realizada en acero inoxidable y Cromall® con contenedores en cristal satinado

Изготовлено из нержавеющей стали и Cromall® с ёмкостями из матового

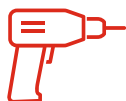

Con viti

With screws



Con colla

With glue

(Venduta a parte  
Sold seperately)



GARANZIA  
WARRANTY



13  
Cromato  
Chromed



14  
Nero matt  
Matt black

**Eros.**

SERIE DA MURO  
Wall series

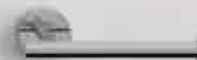

SERIE DA MURO . WALL LINES .

RETAIL





Eros.

SERIE DA MURO  
Wall series



SERIE DA MURO. WALL LINES.

RETAIL



2310

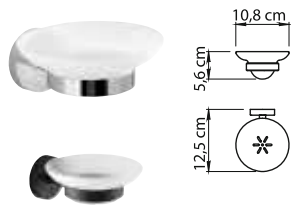

2311



2381

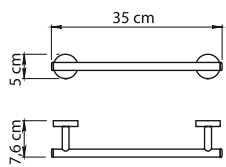

2321-35

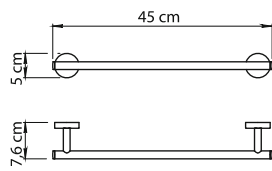

2321-45

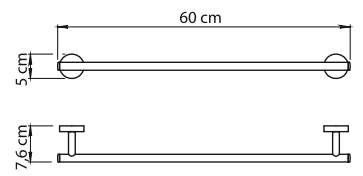

2321-60



Solo con viti  
Only with screws



**2323**

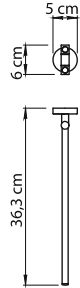

**2370**

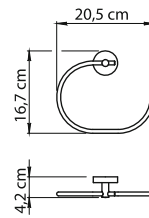

**2326**

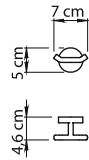

**2324**

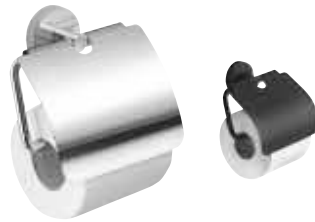
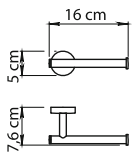

**2325**

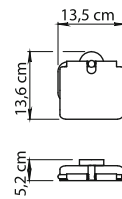

**2355**

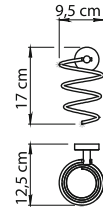

**2319-60**



Vetro temperato  
Tempered glass



Solo con viti  
Only with screws

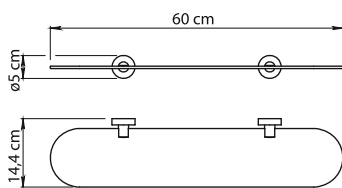

**2333-03**

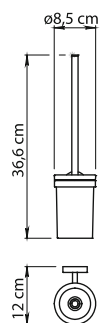

RETAIL

## Vermont Pro.

### Realizzata in acciaio inox e Cromall® con contenitori in vetro satinato

Made of stainless steel and Cromall® with frosted glass containers

Réalisée en acier inoxydable et Cromall® avec boîtiers en verre satiné

Hergestellt aus Edelstahl und Cromall® mit Behältern aus satiniertem Glas

Realizada en acero inoxidable y Cromall® con contenedores en cristal satinado

Изготовлено из нержавеющей стали и Cromall® с ёмкостями из матового стекла

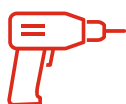

Con viti

With screws



Con colla

With glue



GARANZIA

WARRANTY

(Venduta a parte  
Sold seperately)



13

Cromato  
Chromed

# Vermont Pro.



SERIE DA MURO. WALL LINES.

RETAIL

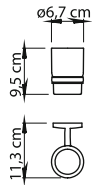

4210

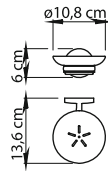

4211

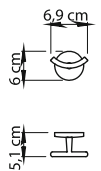

4226

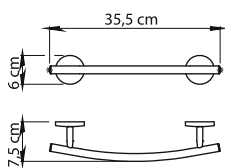

4221-35

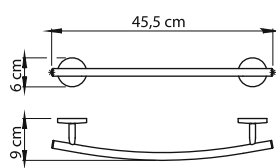

4221-45

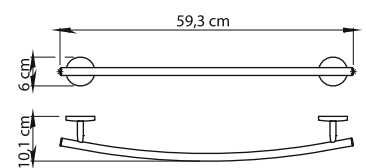

4221-60



Solo con viti  
Only with screws



4223

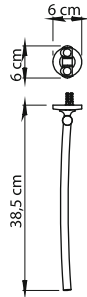

4270

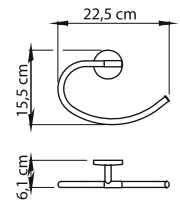

4224

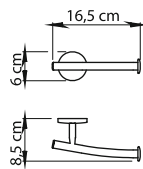

4234

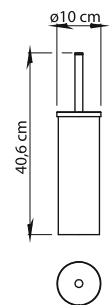

## Project.

### Realizzata in acciaio inox AISI 304 con contenitori in vetro satinato

Made of AISI 304 stainless steel with frosted glass containers

Réalisée en acier inoxydable AISI 304 avec boîtiers en verre satiné

Hergestellt aus Edelstahl AISI 304 mit Behältern aus satiniertem Glas

Realizada en acero inox AISI 304 con contenedores en cristal satinado

Изготовлено из нержавеющей стали AISI 304 с ёмкостями из матового стекла

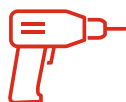

Con viti  
With screws



GARANZIA  
WARRANTY



13  
Lucido  
Polished



38  
Spazzolato  
Brushed





SERIE DA MURO . WALL LINES .

**GEDY**



CONFORME / IN CONFORMITY WITH UNI11064:2003

**KG 180**

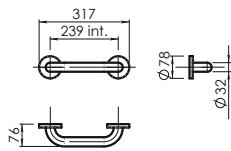

**5020-24**

**KG 160**

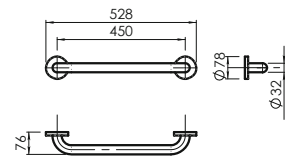

**5020-45**

**KG 160**

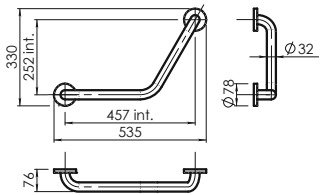

**5022**

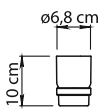

**5010**

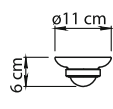

**5011**

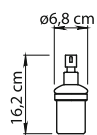

**5081**

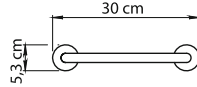

**5021-30**

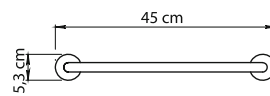

**5021-45**

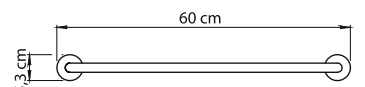

**5021-60**

# Project.

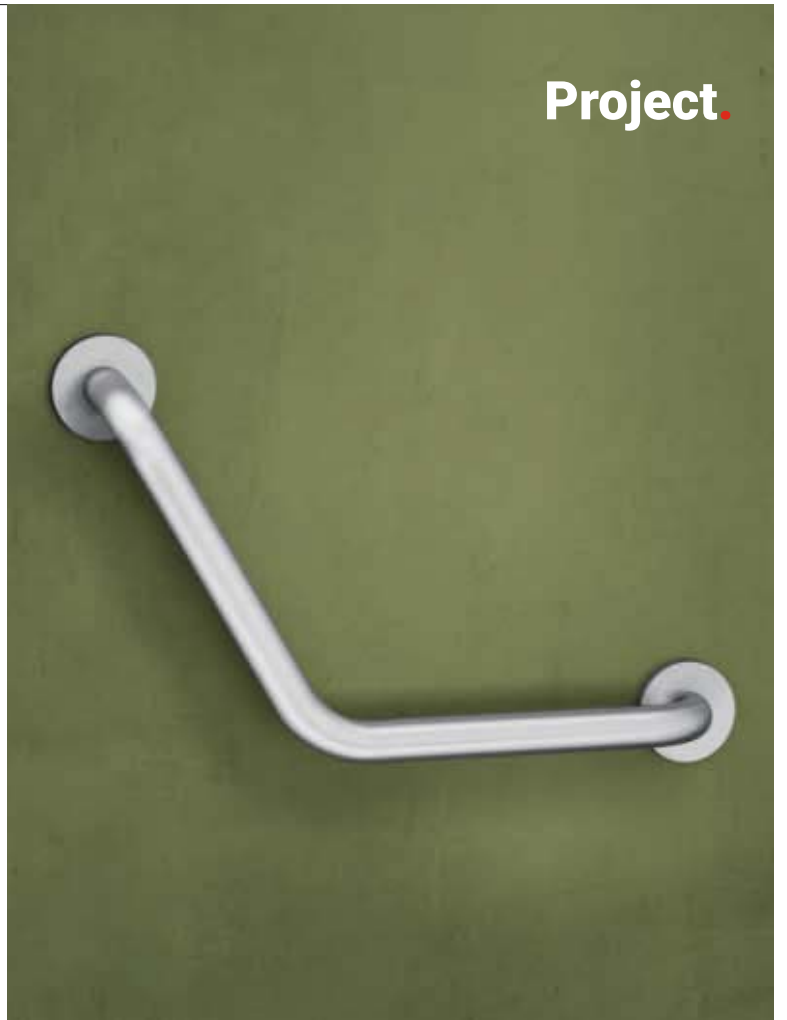

**NEW**

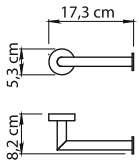
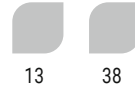

**5024**

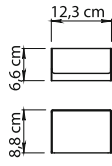

**5025**

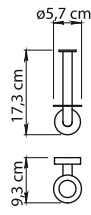

**5024-02**

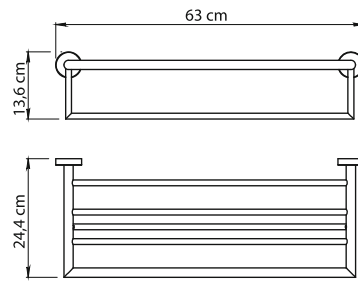

**5044**

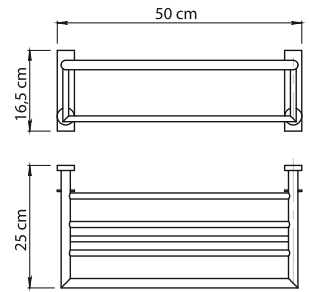

**5035**

13  
solo - only

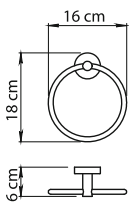

**5070**

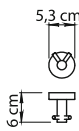

**5026**

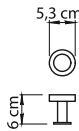

**5027**

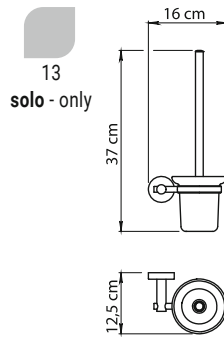

**5033-03**

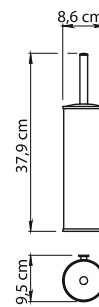

**5034-03**

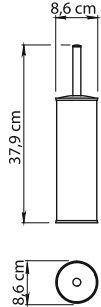

**5034**

GEDY

## Kent.

**Realizzata in ottone e Cromall® con contenitori in vetro satinato**

Made of brass and Cromall® with frosted glass containers

Réalisée en laiton et Cromall® avec boîtiers en verre satiné

Hergestellt aus Messing und Cromall® mit Behältern aus satiniertem Glas

Realizada en latón y Cromall® con contenedores en cristal satinado

Изготовлено из латуни и Cromall® с ёмкостями из матового стекла



Con viti

With screws



GARANZIA

WARRANTY



13  
Cromato  
Chromed

Kent.

SERIE DA MURO  
Wall series





SERIE DA MURO . WALL LINES .

**GEDY**

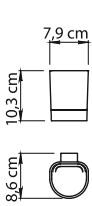

**5510**

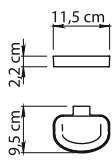

**5511**

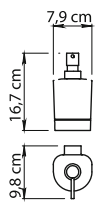

**5581**

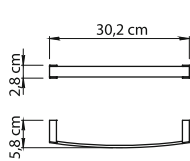

**5521-30**

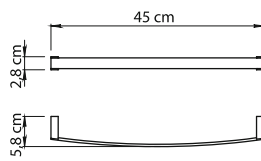

**5521-45**

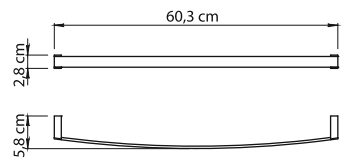

**5521-60**

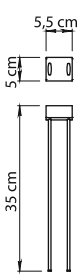
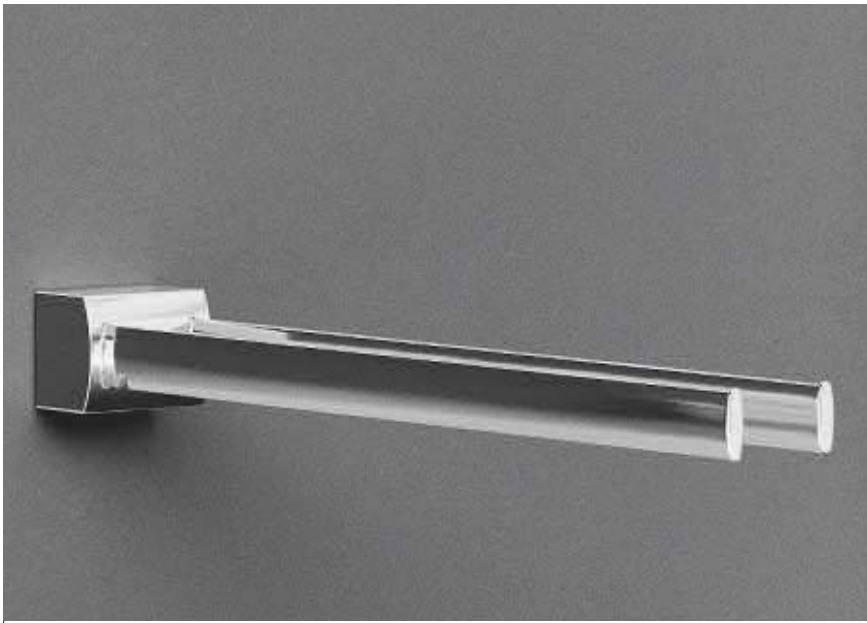

**5522**

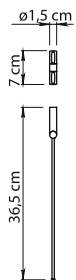

**5523**

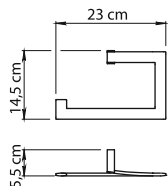

**5570**

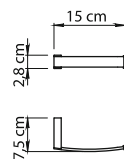

**5524**

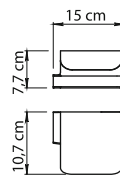

**5525**

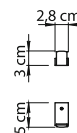

**5527**

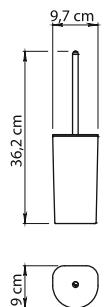

**5533**

## Glamour.

design Piet Billekens

**Realizzata in ottone e Cromall® con contenitori in vetro satinato**

Made of brass and Cromall® with frosted glass containers

Réalisée en laiton et Cromall® avec boîtiers en verre satiné

Hergestellt aus Messing und Cromall® mit Behältern aus satiniertem Glas

Realizada en latón y Cromall® con contenedores en cristal satinado

Изготовлено из латуни и Cromall® с ёмкостями из матового стекла



Con viti  
With screws



GARANZIA  
WARRANTY



13  
Cromato  
Chromed



Glamour.

SERIE DA MURO  
Wall series



SERIE DA MURO. WALL LINES.

**GEDY**

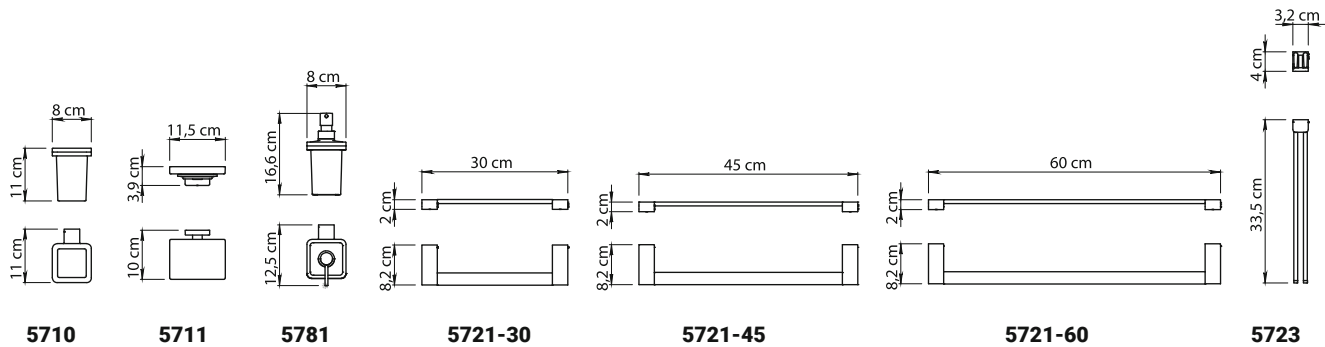
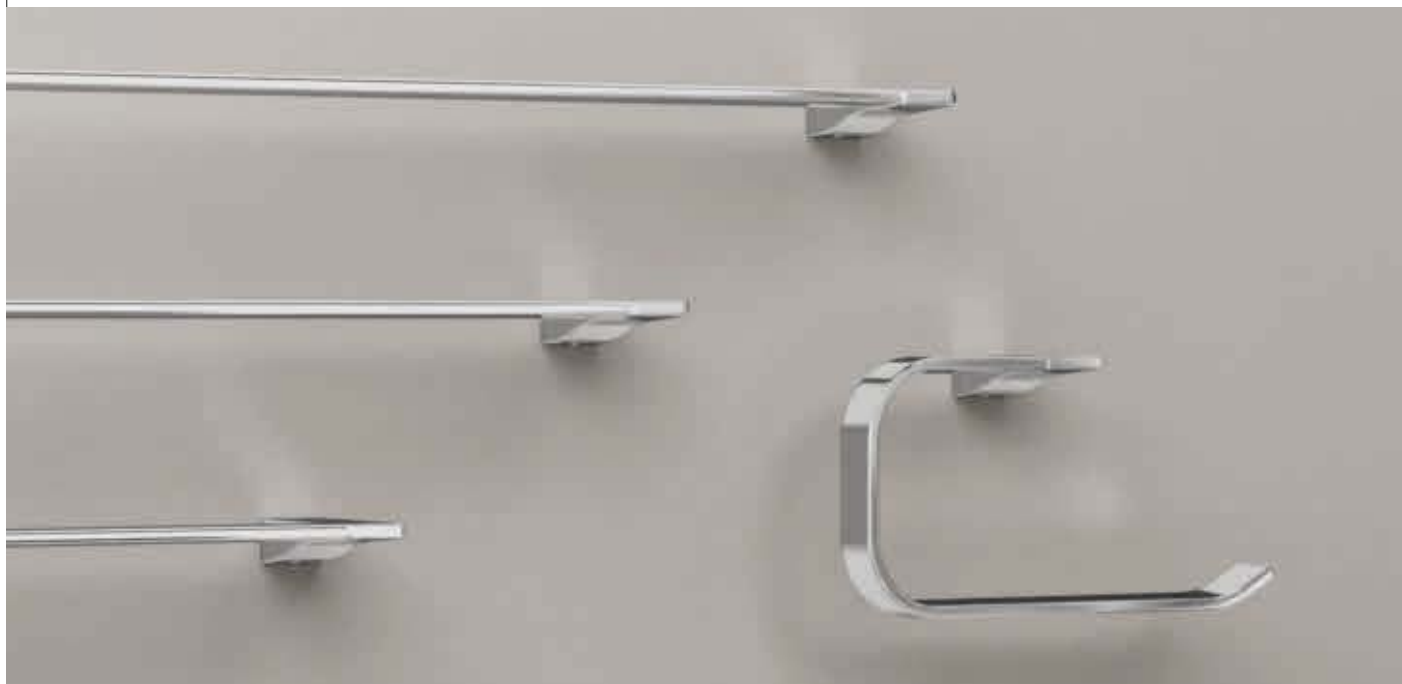

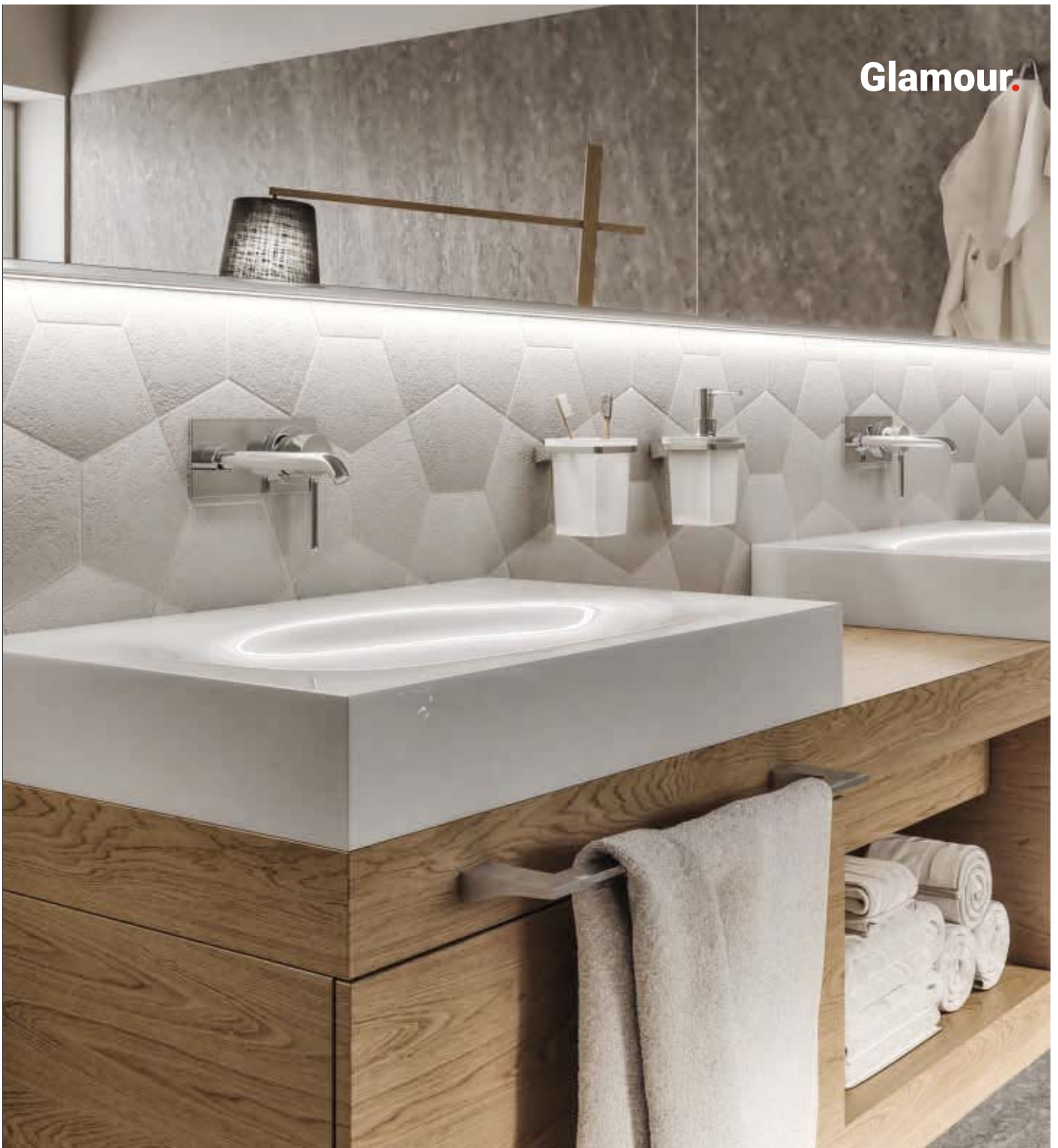

Vetro temperato  
Tempered glass

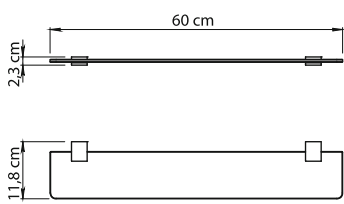

5719-60

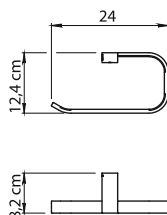

5770

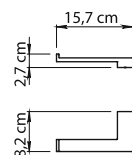

5724

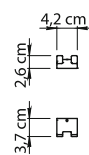

5726

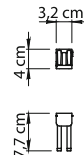

5728

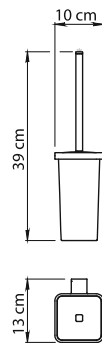

5733-03

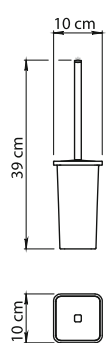

5733

## Pirenei.

### Realizzata in ottone e Cromall® con contenitori in vetro satinato

Made of brass and Cromall® with frosted glass containers

Réalisée en laiton et Cromall® avec boîtiers en verre satiné

Hergestellt aus Messing und Cromall® mit Behältern aus satiniertem Glas

Realizada en latón y Cromall® con contenedores en cristal satinado

Изготовлено из латуни и Cromall® с ёмкостями из матового стекла

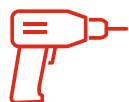

Con viti  
With screws



GARANZIA  
WARRANTY



02  
**Bianco matt**  
Matt white



13  
**Cromato**  
Chromed



14  
**Nero matt**  
Matt black



38  
**Spazzolato**  
Brushed



87  
**Oro**  
Gold



88  
**Oro matt**  
Matt gold

TRATTAMENTO PVD  
PVD PLATED

Pirenei.

SERIE DA MURO  
Wall series



SERIE DA MURO. WALL LINES.

GEDY



Pirenei.

SERIE DA MURO  
Wall series



SERIE DA MURO . WALL LINES .

GEDY

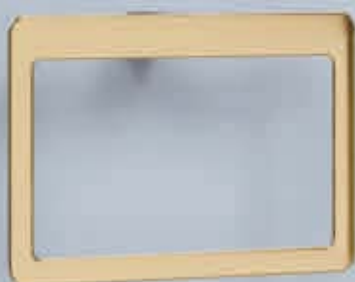



Pirenei.

SERIE DA MURO  
Wall series



**GEDY**

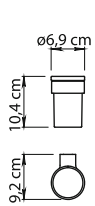

**PI10**

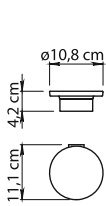

**PI11**

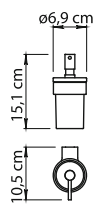

**PI81**

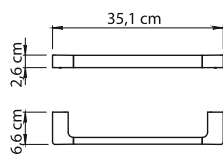

**PI21-35**

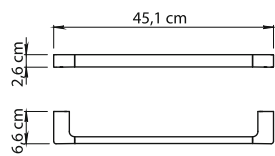

**PI21-45**

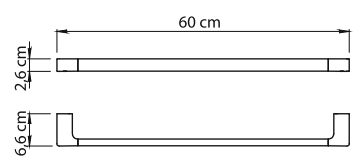

**PI21-60**

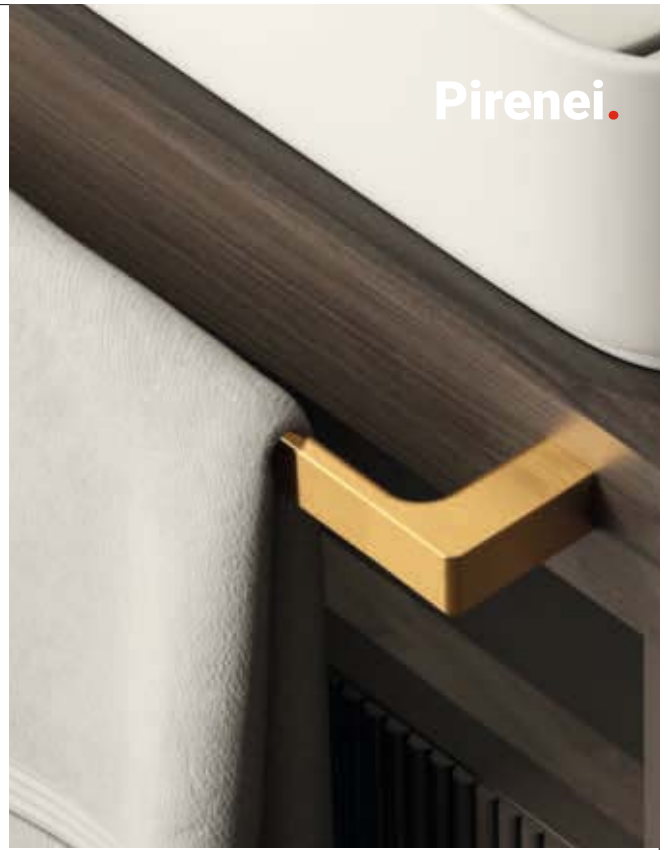

Pirenei.



13 - 02 - 14  
\*solo - only

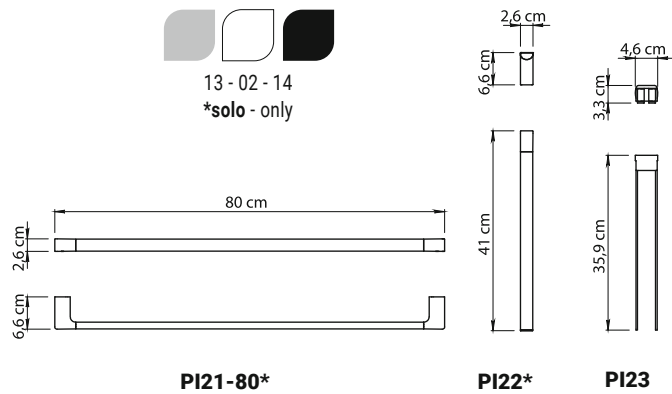

PI21-80\*

PI22\*

PI23

PI70

PI24

PI27  
2 pz - 2 pcs

PI33-03

## Kansas.

**Realizzata in acciaio inox e Cromall® con contenitori in vetro satinato o acciaio inox**

Made of stainless steel and Cromall® with frosted glass containers or stainless steel

Réalisée en acier inoxydable et Cromall® avec boîtiers en verre satiné ou acier inoxydable

Hergestellt aus Edelstahl und Cromall® mit Behältern aus satiniertem Glas oder Edelstahl

Realizada en acero inoxidable y Cromall® con contenedores en cristal satinado o acero inoxidable

Изготовлено из нержавеющей стали и Cromall® с ёмкостями из матового стекла или нержавеющей стали

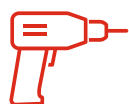

Con viti  
With screws



GARANZIA  
WARRANTY



13  
Cromato  
Chromed

Kansas.

SERIE DA MURO  
Wall series

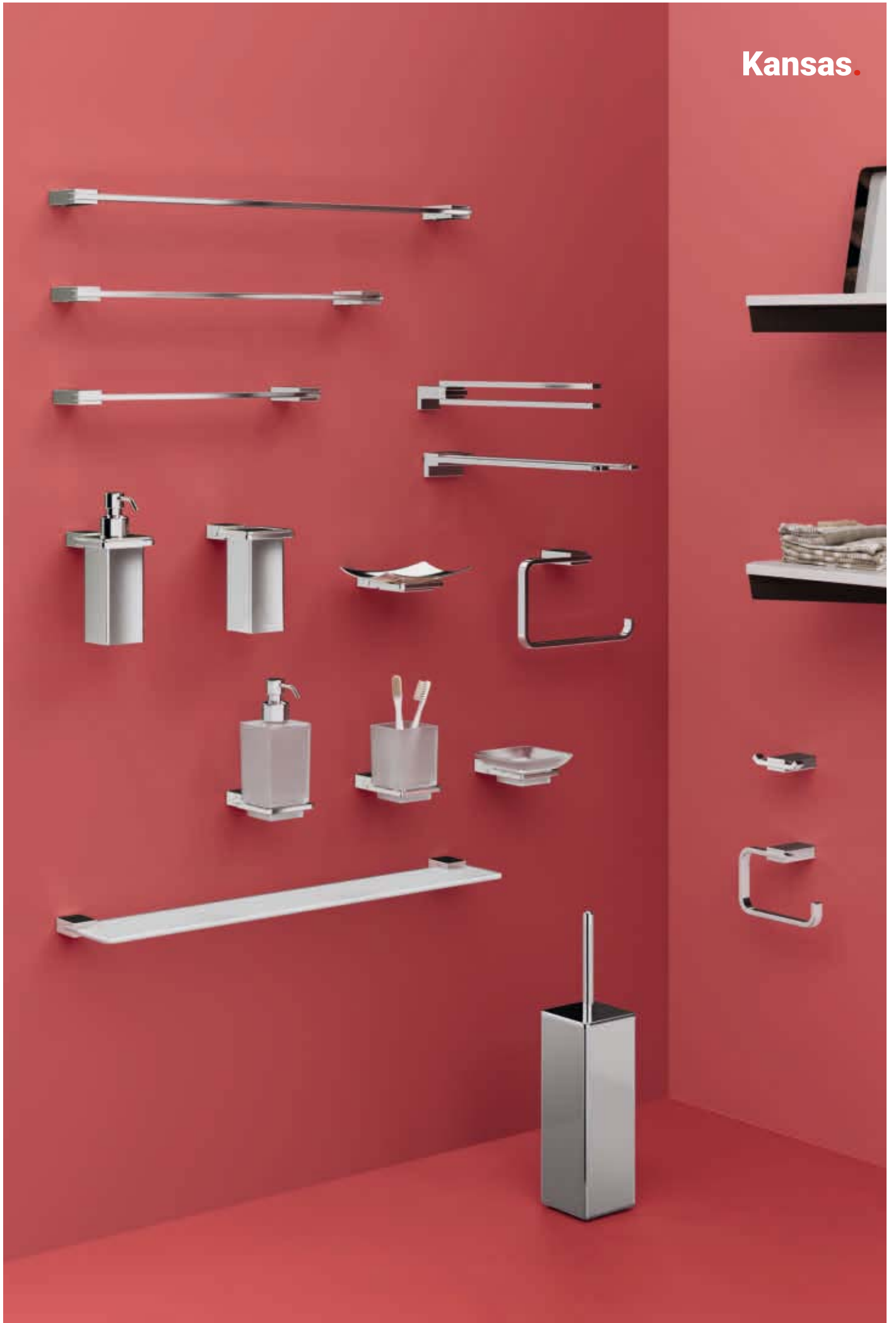

**GEDY**

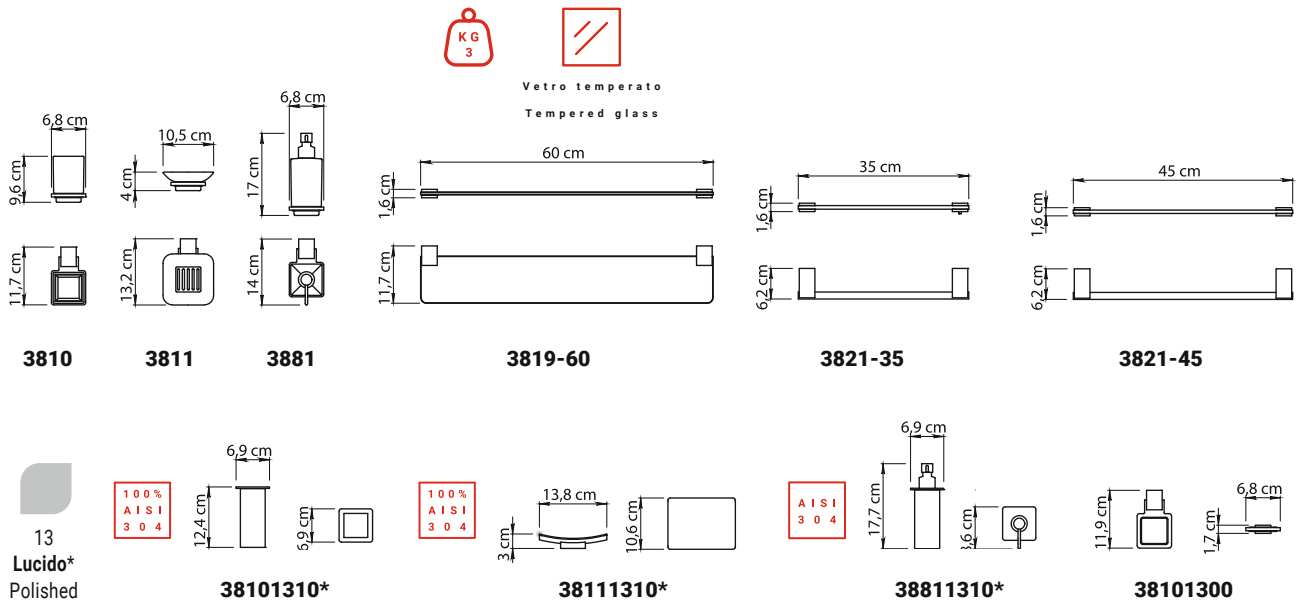
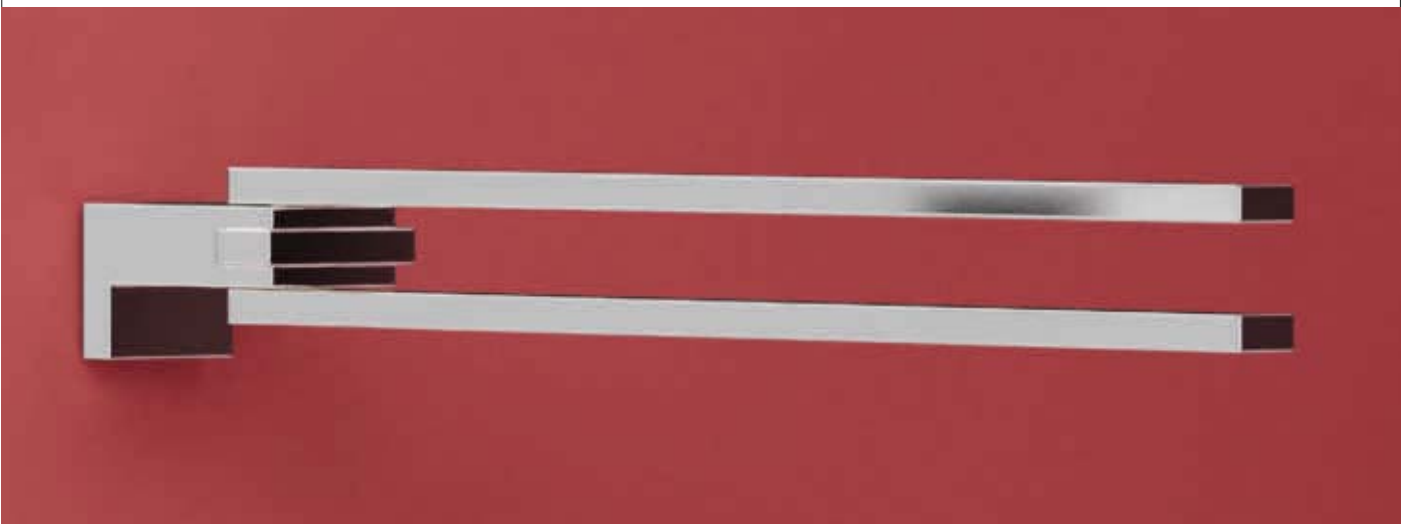

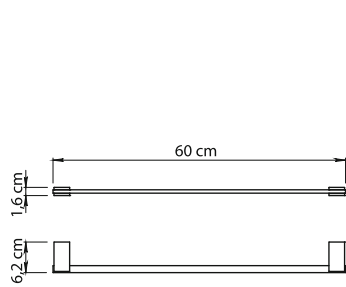

**3821-60**

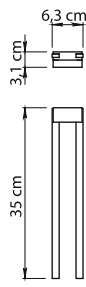

**3822**

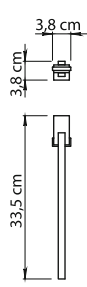

**3823**

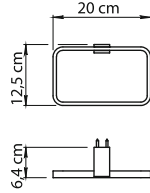

**3870**

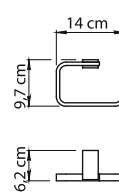

**3824**

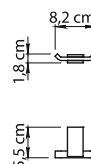

**3826**

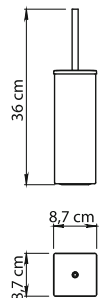

**3833**



13  
**Lucido**  
Polished



**2**  
YEARS  
GARANZIA  
WARRANTY



GEDY

## Gran Torino.

**Realizzata in acciaio inox, ottone e Cromall® con contenitori in metacrilato trasparente**

Made of stainless steel, brass and Cromall® with transparent methacrylate containers

Réalisée en acier inoxydable, laiton et Cromall® avec boîtiers en méthacrylate transparent

Hergestellt aus Edelstahl, Messing und Cromall® mit durchsichtigen Behältern aus Methacrylat

Realizada en acero inox, latón y Cromall® con contenedores en metacrilato transparente

Изготовлено из нержавеющей стали, латуни и Cromall® с контейнерами

из прозрачного метакрилата

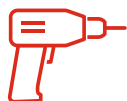

Con viti

With screws



GARANZIA  
WARRANTY



84  
Nero lucido  
Mirror black

TRATTAMENTO PVD  
PVD PLATED



# Gran Torino.

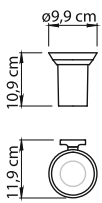

**GT10**

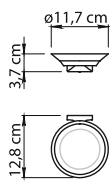

**GT11**

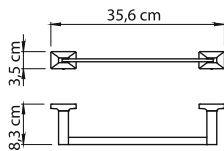

**GT21-30**

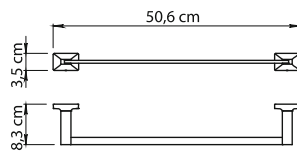

**GT21-45**

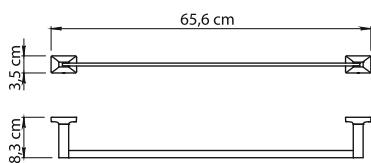

**GT21-60**

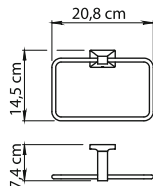

**GT70**

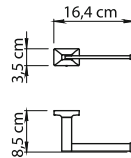

**GT24**

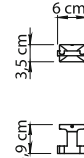

**GT26**

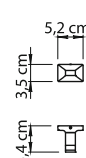

**GT27**

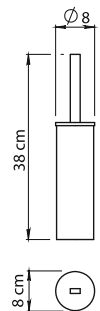

**GT33**

## Maine.

### Realizzata in acciaio inox e Cromall® con contenitori in vetro satinato

Made of stainless steel and Cromall® with frosted glass containers

Réalisée en acier inoxydable et Cromall® avec boîtiers en verre satiné

Hergestellt aus Edelstahl und Cromall® mit Behältern aus satiniertem Glas

Realizada en acero inoxidable y Cromall® con contenedores en cristal satinado

Изготовлено из нержавеющей стали и Cromall® с ёмкостями из матового стекла

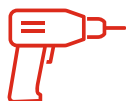

Con viti  
With screws



Con colla  
With glue



Gira la placca  
come vuoi

Turn the plate



GARANZIA  
WARRANTY

(Venduta a parte  
Sold seperately)



13  
Cromato  
Chromed

Maine.

SERIE DA MURO  
Wall series



SERIE DA MURO . WALL LINES .

**GEDY**

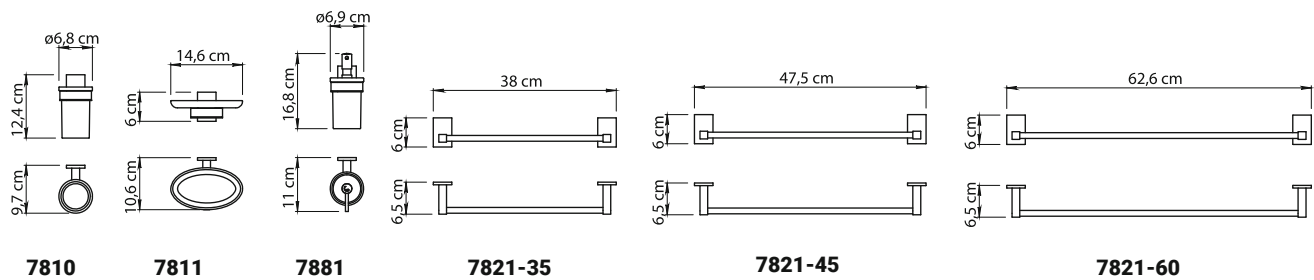
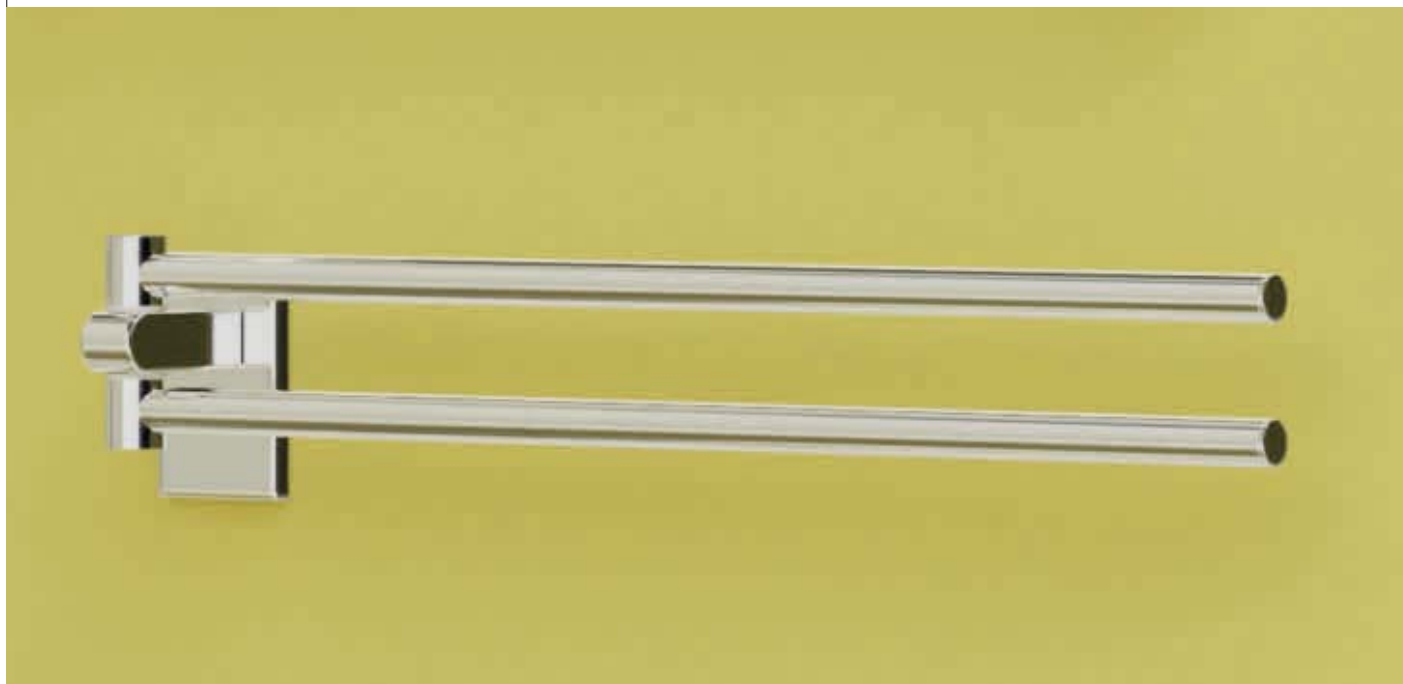



Maine.



Vetro temperato Solo con viti  
Tempered glass Only with screws

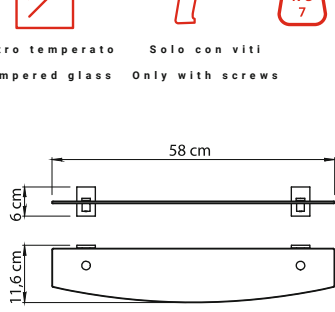

7819-60

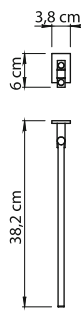

7823

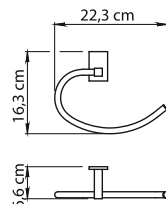

7870

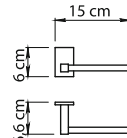

7824

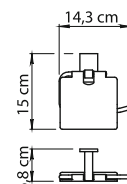

7825

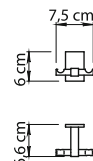

7826

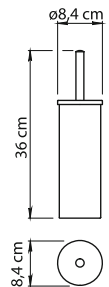

7833

## Bernina.

### Realizzata in acciaio inox e Cromall® con contenitori in vetro satinato

Made of stainless steel and Cromall® with frosted glass containers

Réalisée en acier inoxydable et Cromall® avec boîtiers en verre satiné

Hergestellt aus Edelstahl und Cromall® mit Behältern aus satiniertem Glas

Realizada en acero inoxidable y Cromall® con contenedores en cristal satinado

Изготовлено из нержавеющей стали и Cromall® с ёмкостями из матового стекла

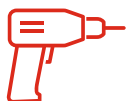

Con viti

With screws



Con colla

With glue

(Venduta a parte  
Sold seperately)



GARANZIA  
WARRANTY



13  
Cromato  
Chromed

Bernina.

SERIE DA MURO  
Wall series



SERIE DA MURO . WALL LINES .

GEDY

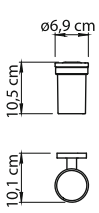
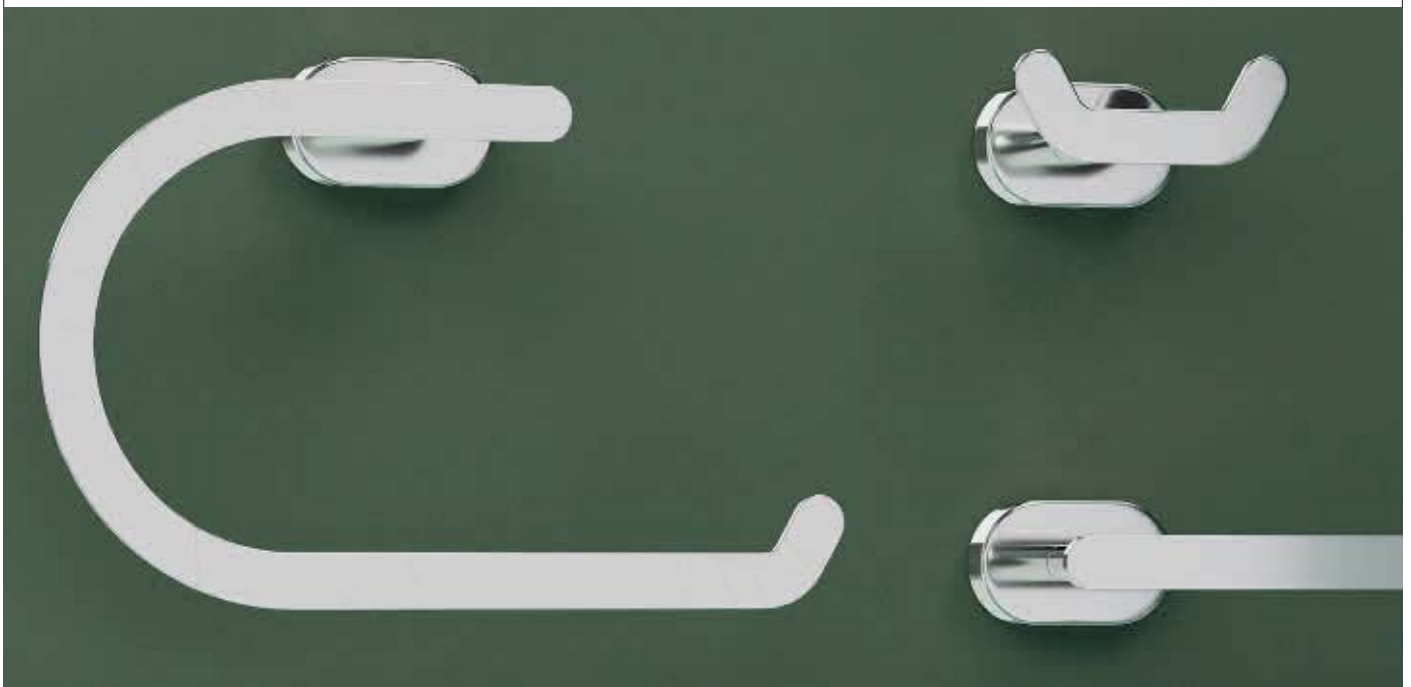
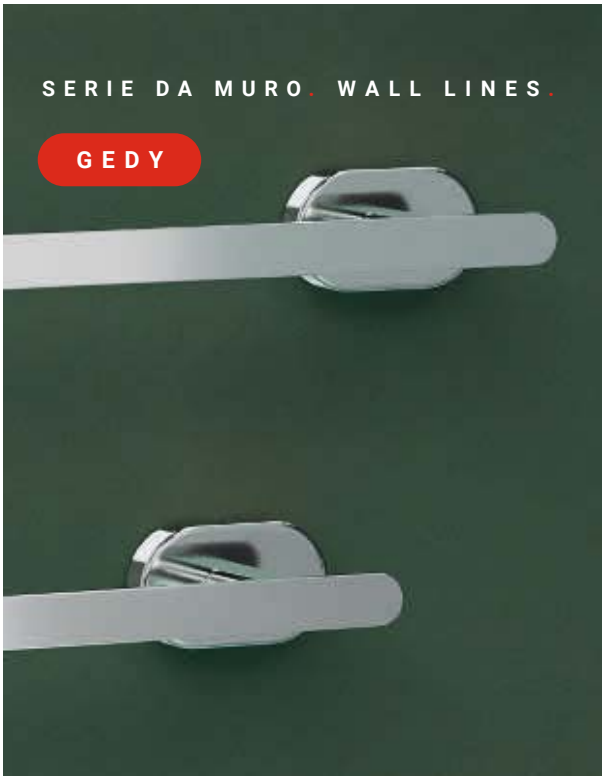

BE10

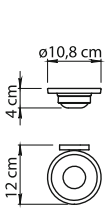

BE11

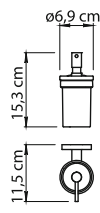

BE81

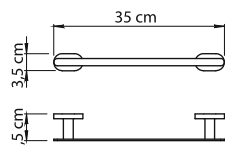

BE21-35

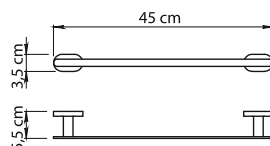

BE21-45

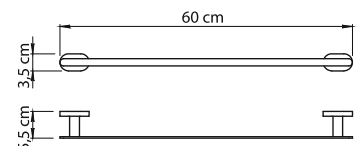

BE21-60



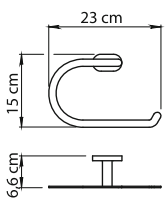

**BE70**

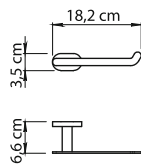

**BE24**

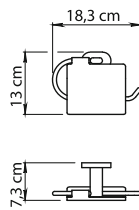

**BE25**

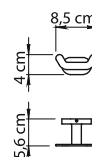

**BE26**

## Romance.

### Realizzata in acciaio inox e Cromall® con contenitori in vetro satinato

Made of stainless steel and Cromall® with frosted glass containers

Réalisée en acier inoxydable et Cromall® avec boîtiers en verre satiné

Hergestellt aus Edelstahl und Cromall® mit Behältern aus satiniertem Glas

Realizada en acero inoxidable y Cromall® con contenedores en cristal satinado

Изготовлено из нержавеющей стали и Cromall® с ёмкостями из матового стекла

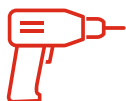

Con viti

With screws



Con colla

With glue

(Venduta a parte  
Sold seperately)



GARANZIA  
WARRANTY



44  
Bronzo  
Bronze

Romance.

SERIE DA MURO  
Wall series



SERIE DA MURO . WALL LINES .

**GEDY**



**10 / 35**  
Lunghezza modificabile  
Adjustable length

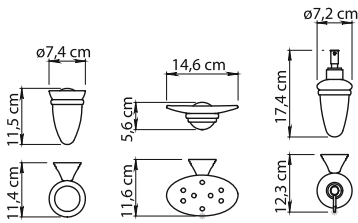

**7510**

**7511**

**7581**



**10 / 45**  
Lunghezza modificabile  
Adjustable length

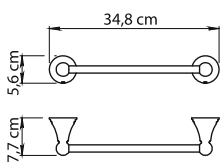

**7521-35**

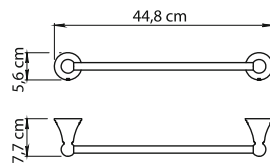

**7521-45**



**10 / 60**  
Lunghezza modificabile  
Adjustable length

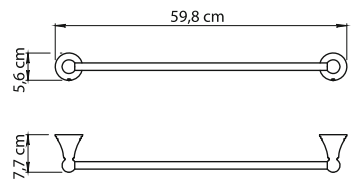

**7521-60**

# Romance



Vetro temperato Solo con viti  
Tempered glass Only with screws

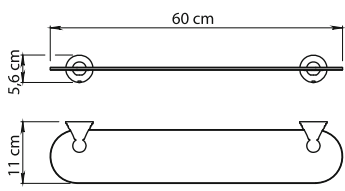

7519-60

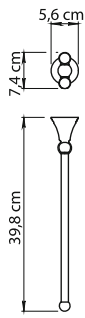

7523

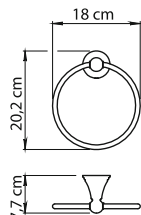

7570

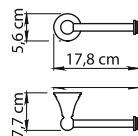

7524

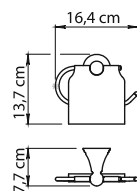

7525

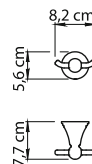

7526

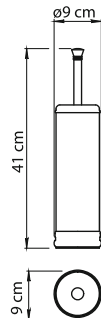

7533

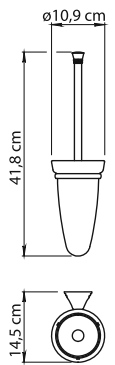

7533-03

GEDY

## Colorado.

**Realizzata in acciaio inox AISI 304 e Cromall® con contenitori in vetro satinato o acciaio inox**

Made of AISI 304 stainless steel and Cromall® with frosted glass containers or stainless steel

Réalisée en acier inoxydable AISI 304 et Cromall® avec boîtiers en verre satiné ou acier inoxydable

Hergestellt aus Edelstahl AISI 304 und Cromall® mit Behältern aus satiniertem Glas oder Edelstahl

Realizada en acero inoxidable AISI 304 y Cromall® con contenedores en cristal satinado o acero inoxidable

Изготовлено из нержавеющей стали AISI 304 и Cromall® с ёмкостями из матового стекла или нержавеющей стали

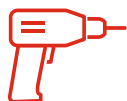

Con viti  
With screws



Con colla  
With glue  

---

**(Venduta a parte  
Sold seperately)**



**GARANZIA  
WARRANTY**



13  
**Cromato  
Chromed**





**GEDY**

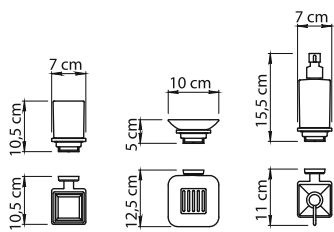

**6910**

**6911**

**6981**



**10 / 35**  
Lunghezza modificabile  
Adjustable length

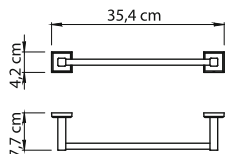

**6921-35**



**10 / 45**  
Lunghezza modificabile  
Adjustable length

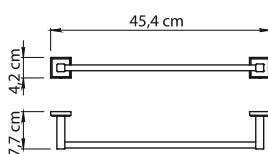

**6921-45**



**10 / 60**  
Lunghezza modificabile  
Adjustable length

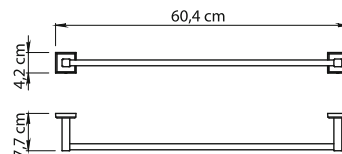

**6921-60**





13  
Lucido\*  
Polished

100%  
AISI  
304

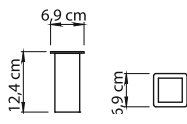

38101310\*

100%  
AISI  
304

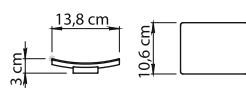

38111310\*

AISI  
304

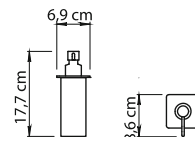

38811310\*



69101300

13  
Lucido  
Polished

2  
YEARS  
GARANZIA  
WARRANTY



Vetro temperato  
Tempered glass



Solo con viti  
Only with screws



6923

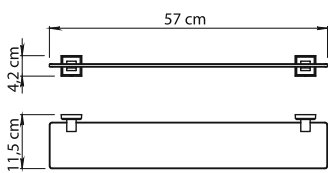

6919-60

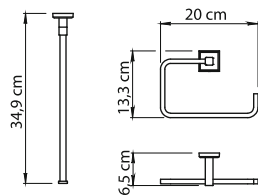

6970

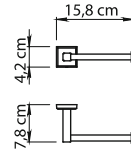

6924

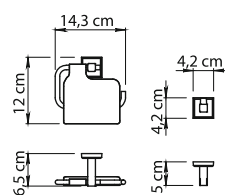

6925

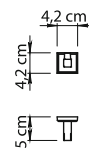

6926

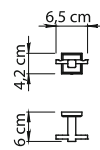

6928

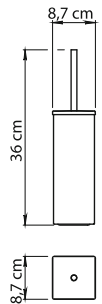

6933

GEDY

**Nevis.**



**Realizzata in acciaio inox e Cromall® con contenitori in ceramica**

Made of stainless steel and Cromall® with pottery containers

Réalisée en acier inoxydable et Cromall® avec boîtiers en céramique

Hergestellt aus Edelstahl und Cromall® mit Behältern aus Keramik

Realizada en acero inoxidable y Cromall® con contenedores en cerámica

Изготовлено из нержавеющей стали и Cromall® с ёмкостями из керамики

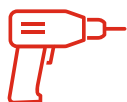

Con viti

With screws



GARANZIA

WARRANTY



13

Cromato  
Chromed

Nevis.

SERIE DA MURO  
Wall series



SERIE DA MURO . WALL LINES .

GEDY

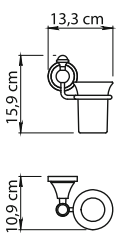

NV10

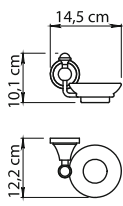

NV11

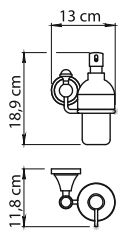

NV80

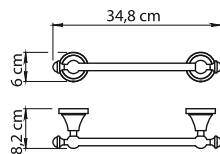

NV21-30

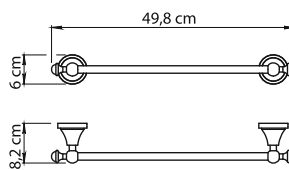

NV21-45

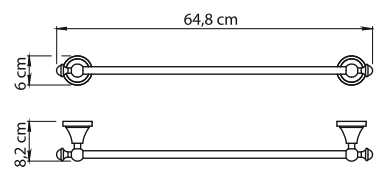

NV21-60

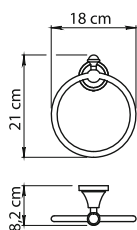

**NV70**

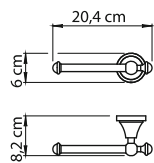

**NV24**

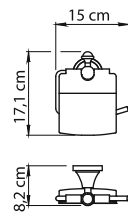

**NV25**

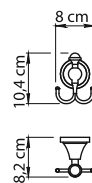

**NV26**

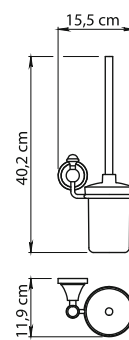

**NV33-03**

GEDY

## Spluga.



**Realizzata in acciaio inox, alluminio e Cromall® con contenitori in ceramica**

Made of stainless steel, aluminium and Cromall® with pottery containers

Réalisée en acier inoxydable, aluminium et Cromall® avec boîtiers en céramique

Hergestellt aus Edelstahl, Aluminium und Cromall® mit Behältern aus Keramik

Realizada en acero inoxidable, aluminio y Cromall® con contenedores en cerámica

Изготовлено из нержавеющей стали, алюминия и Cromall® с ёмкостями из керамики

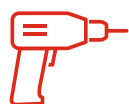

Con viti

With screws



GARANZIA

WARRANTY



13  
Cromato  
Chromed



Spluga.

SERIE DA MURO  
Wall series



SERIE DA MURO. WALL LINES.

GEDY

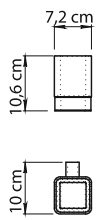

**SG10**

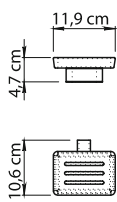

**SG11**

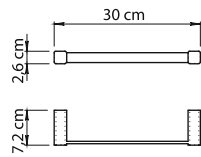

**SG21-30**

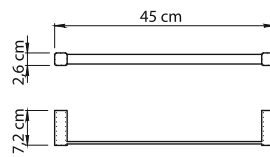

**SG21-45**

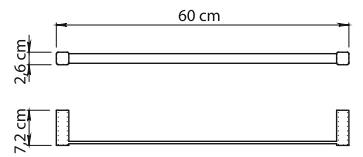

**SG21-60**



Spluga.

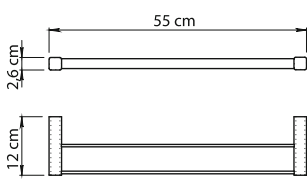

**SG22**

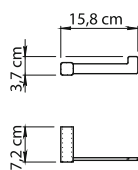

**SG24**

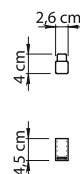

**SG26**

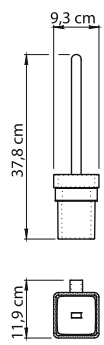

**SG33-03**

## New Jersey.

### Realizzata in acciaio inox, Cromall® e resine termoplastiche con contenitori in vetro satinato

Made of stainless steel, Cromall® and thermoplastic resins with frosted glass containers

Réalisée en acier inoxydable, Cromall® et résine thermoplastique avec boîtiers en verre satiné

Hergestellt aus Edelstahl, Cromall® und Kunststoff mit Behältern aus satiniertem Glas

Realizada en acero inox, Cromall® y resinas termoplásticas con contenedores en cristal satinado

Изготовлено из нержавеющей стали, Cromall® и термопластичных смол и матового стекла

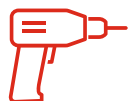

Con viti  
With screws



Con colla  
With glue  

---

*(Venduta a parte  
Sold seperately)*



GARANZIA  
WARRANTY



13  
Cromato  
Chromed

# New Jersey.

SERIE DA MURO  
Wall series

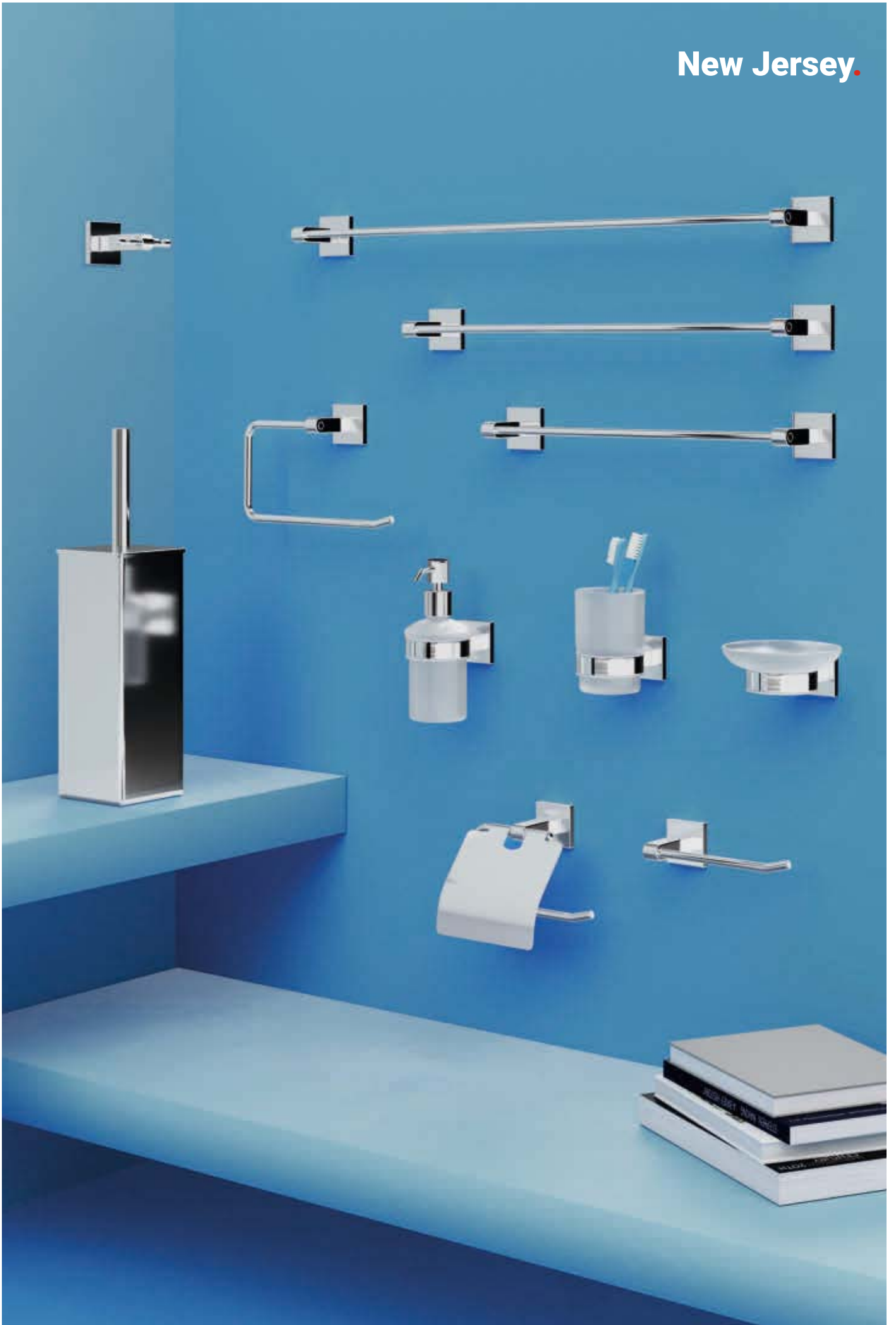

SERIE DA MURO . WALL LINES .

**GEDY**

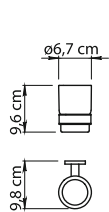

**2810**

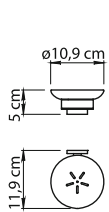

**2811**

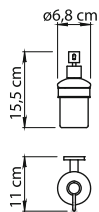

**2881**

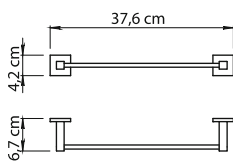

**2821-35**

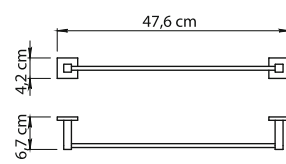

**2821-45**

# New Jersey.

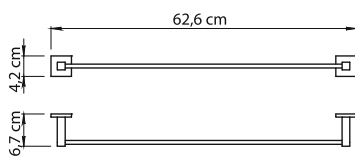

2821-60

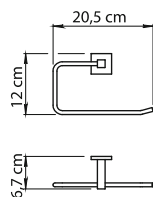

2870

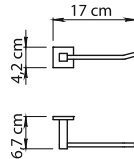

2824

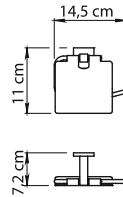

2825

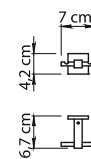

2826

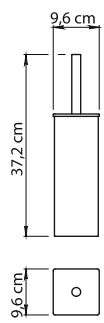

2833

13  
Lucido  
Polished

**2**  
YEARS  
GARANZIA  
WARRANTY

## Edera Plus.

### Realizzata in acciaio inox e Cromall® con contenitori in vetro satinato

Made of stainless steel and Cromall® with frosted glass containers

Réalisée en acier inoxydable et Cromall® avec boîtiers en verre satiné

Hergestellt aus Edelstahl und Cromall® mit Behältern aus satiniertem Glas

Realizada en acero inoxidable y Cromall® con contenedores en cristal satinado

Изготовлено из нержавеющей стали и Cromall® с ёмкостями из матового стекла

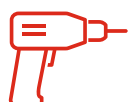

Con viti

With screws



Con colla

With glue

(Venduta a parte  
Sold seperately)



GARANZIA  
WARRANTY



13  
Cromato  
Chromed



# Edera Plus.

SERIE DA MURO  
Wall series



SERIE DA MURO . WALL LINES .

**GEDY**

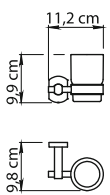

**EP10**

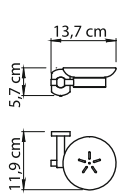

**EP11**

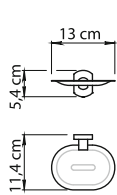

**EP12**

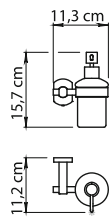

**EP81**



**10 / 35**  
Lunghezza modificabile  
Adjustable length

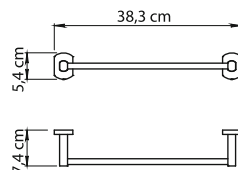

**EP21-35**



**10 / 45**  
Lunghezza modificabile  
Adjustable length

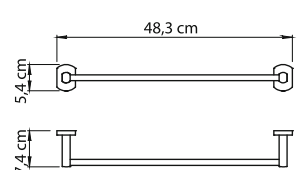

**EP21-45**





# Edera Plus.

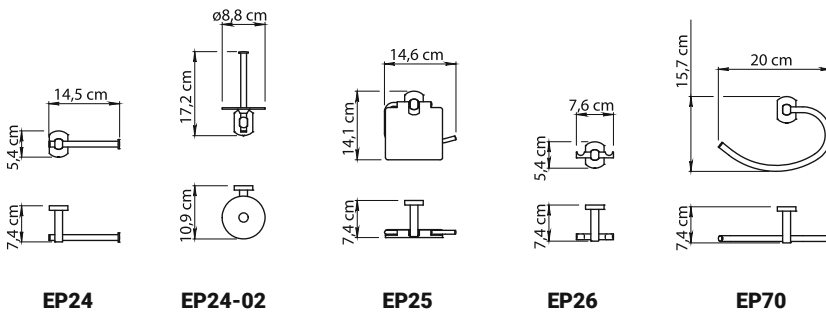

EP24

EP24-02

EP25

EP26

EP70



Solo con viti  
Only with screws



10 / 60  
Lunghezza modificabile  
Adjustable length



Vetro temperato  
Tempered glass



Solo con viti  
Only with screws

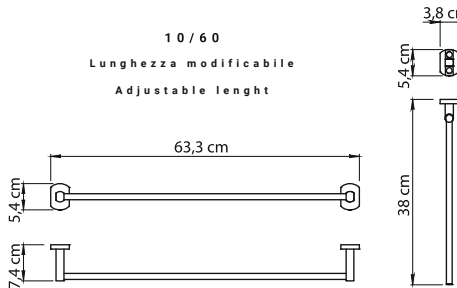

EP21-60

EP23

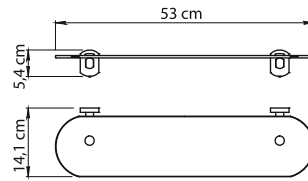

EP19-55



13  
Lucido  
Polished



13  
Lucido  
Polished



13  
Lucido  
Polished

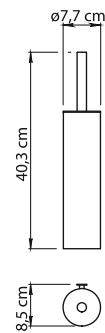

ED34-03

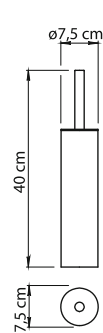

ED34

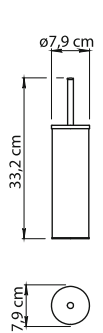

EP33

GEDY

## Wizard.

**Realizzata in ottone e Cromall® con contenitori in metacrilato trasparente**

Made of brass and Cromall® with transparent methacrylate containers

Réalisée en laiton et Cromall® avec boîtiers en méthacrylate transparent

Hergestellt aus Messing und Cromall® mit durchsichtigen Behältern aus Methacrylat

Realizada en latón y Cromall® con contenedores en metacrilato transparente

Изготовлено из латуни и Cromall® с контейнерами из прозрачного метакрилата



Con biadesivo  
With double sided  
tape



GARANZIA  
WARRANTY



13  
Cromato  
Chromed



10 / 35

Lunghezza modificabile  
Adjustable length



10 / 50

Lunghezza modificabile  
Adjustable length

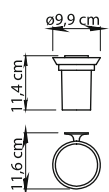

WZ10

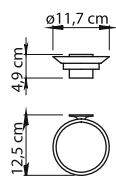

WZ11

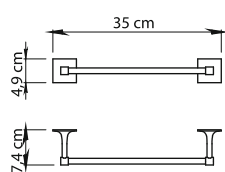

WZ21-30

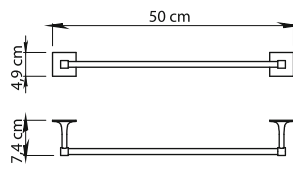

WZ21-45

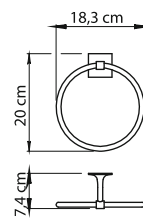

WZ70

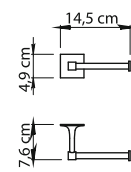

WZ24



WZ27

GEDY

## Tonga.



**Realizzata in acciaio inox e Cromall® con contenitori in vetro satinato**

Made of stainless steel and Cromall® with frosted glass containers

Réalisée en acier inoxydable et Cromall® avec boîtiers en verre satiné

Hergestellt aus Edelstahl und Cromall® mit Behältern aus satiniertem Glas

Realizada en acero inoxidable y Cromall® con contenedores en cristal satinado

Изготовлено из нержавеющей стали и Cromall® с ёмкостями из матового стекла

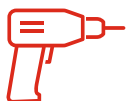

Con viti

With screws



Con biadesivo

With double sided  
tape



GARANZIA

WARRANTY



02

**Bianco matt**  
Matt white



13

**Cromato**  
Chromed



14

**Nero matt**  
Matt black

# Tonga.

SERIE DA MURO  
Wall series



SERIE DA MURO WALL LINES

GEDY

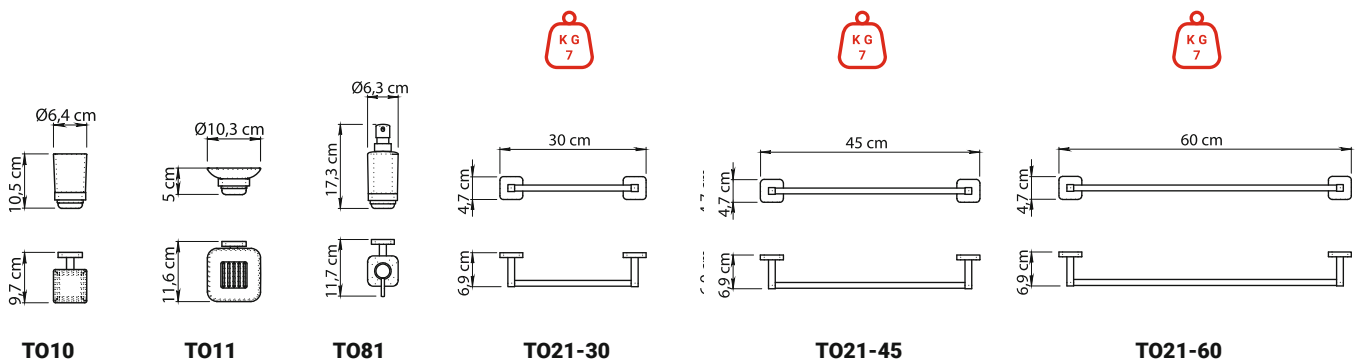



# Tonga.



Solo con viti  
Only with screws

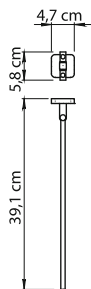

**T023**

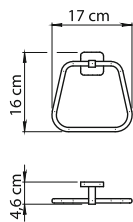

**T070**

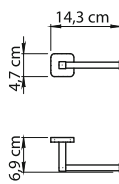

**T024**

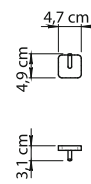

**T027**  
2 pz - 2 pcs

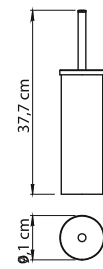

**T033**



02  
**Bianco matt**  
Matt white



13  
**Lucido**  
Polished



14  
**Nero matt**  
Matt black

## Fuji.

### Realizzata in acciaio inox AISI 304 e Cromall® con contenitori in vetro satinato

Made of AISI 304 stainless steel and Cromall® with frosted glass containers

Réalisée en acier inoxydable AISI 304 et Cromall® avec boîtiers en verre satiné

Hergestellt aus Edelstahl AISI 304 und Cromall® mit Behältern aus satiniertem

Realizada en acero inox AISI 304 y Cromall® con contenedores en cristal satinado

Изготовлено из нержавеющей стали AISI 304 и Cromall® с ёмкостями из матового стекла

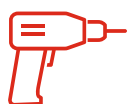

Con viti

With screws



Con biadesivo

With double sided  
tape



GARANZIA  
WARRANTY



13  
Cromato  
Chromed



38  
Spazzolato  
Brushed



Fuji.

SERIE DA MURO  
Wall series

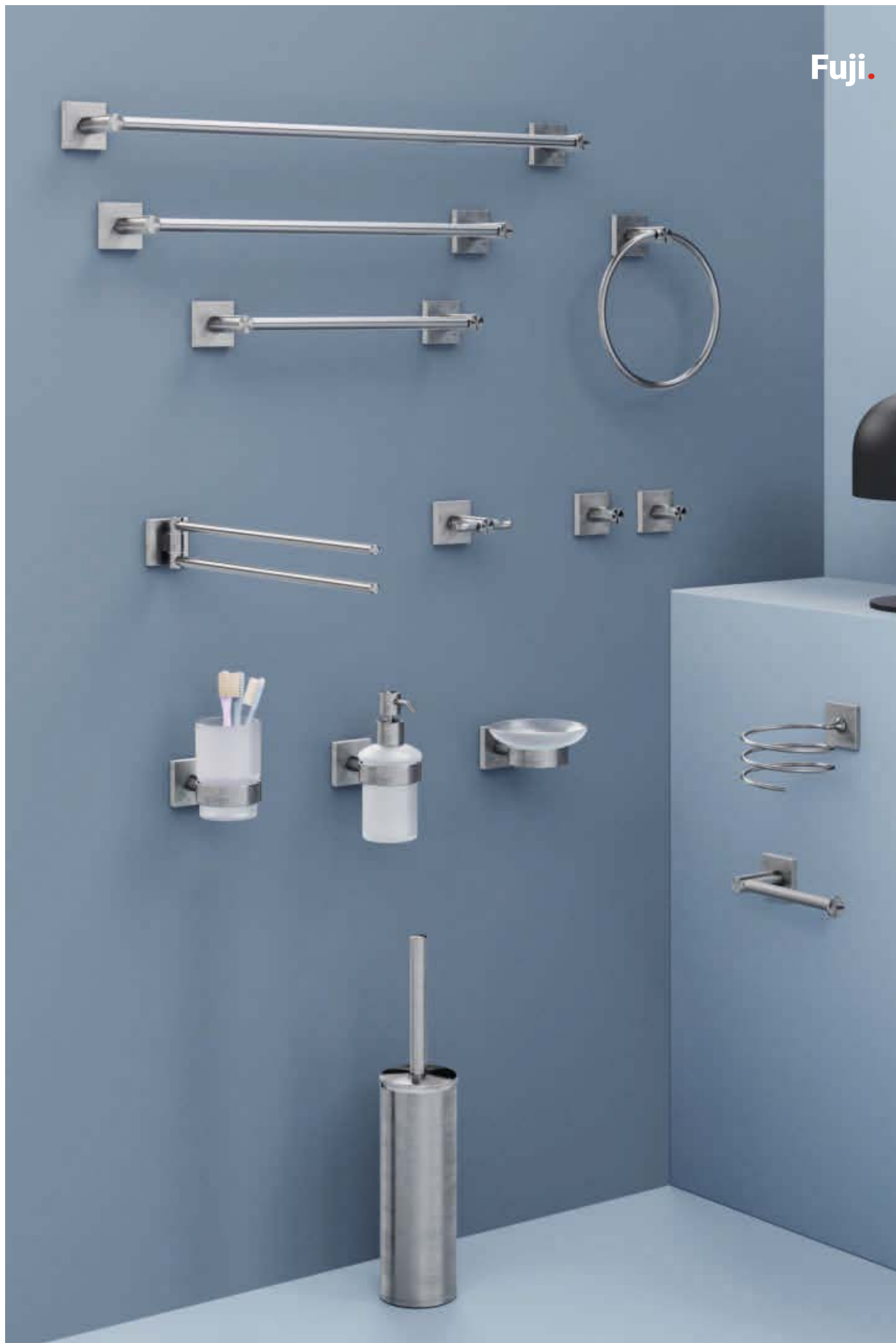

SERIE DA MURO . WALL LINES .

**GEDY**

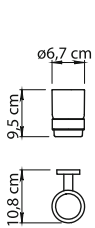
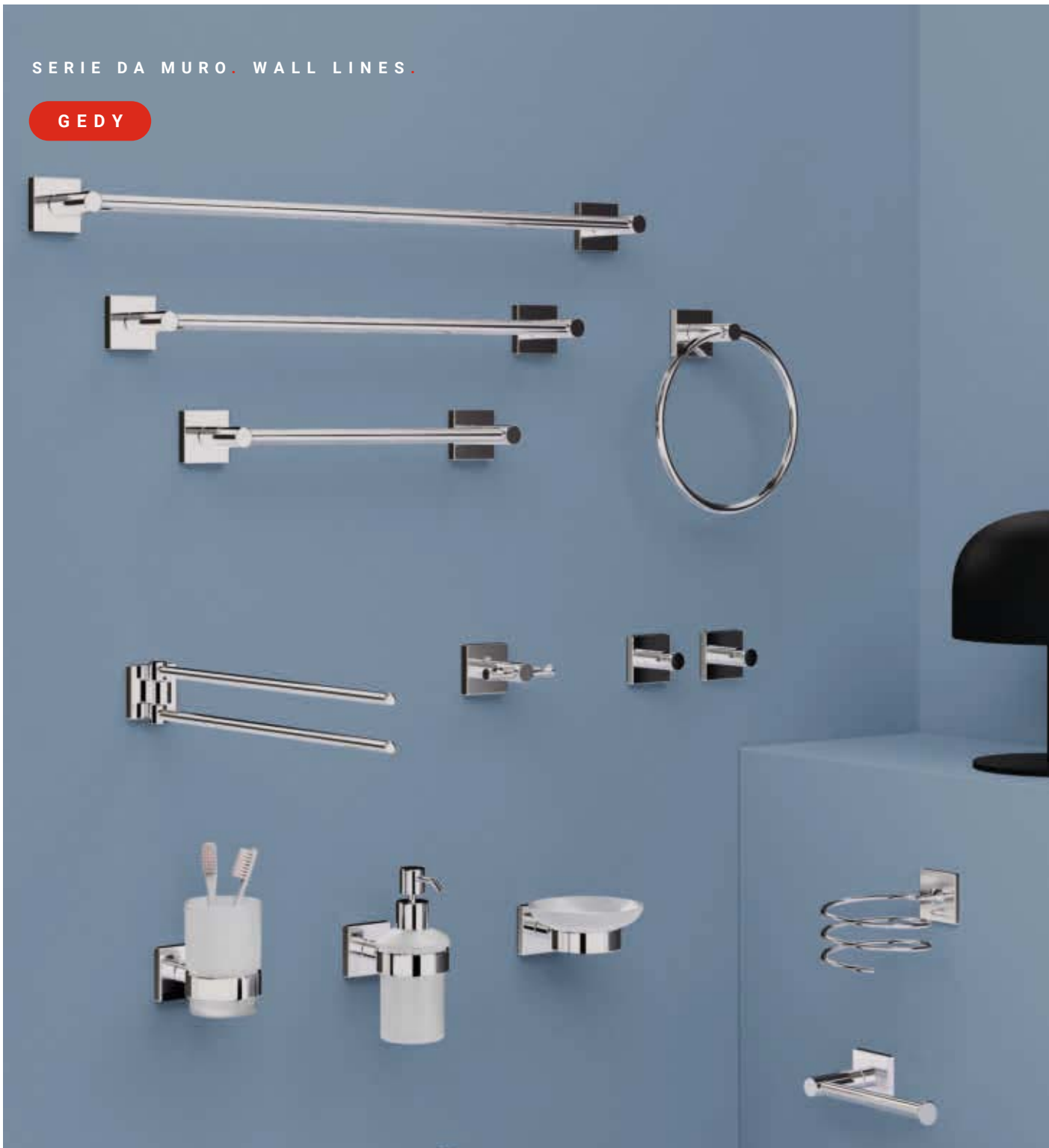

**FJ10**

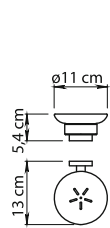

**FJ11**

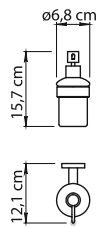

**FJ81**

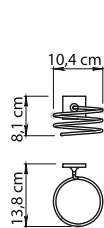

**FJ55**



10 / 30

Lunghezza modificabile  
Adjustable length

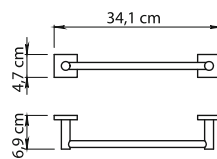

**FJ21-30**



10 / 45

Lunghezza modificabile  
Adjustable length

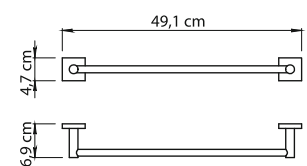

**FJ21-45**



10 / 60  
Lunghezza modificabile  
Adjustable length

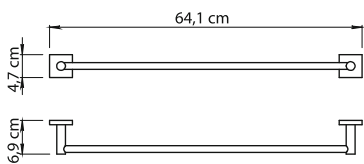

**FJ21-60**

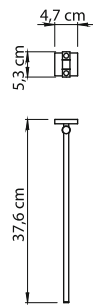

**FJ23**

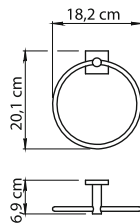

**FJ70**

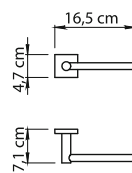

**FJ24**

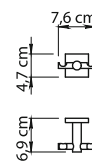

**FJ26**

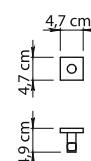

**FJ27**  
2 pz - 2 pcs

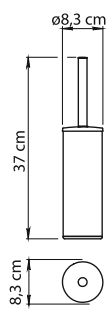

**FJ33**

GEDY

## Stelvio.

### Realizzata in acciaio inox e Cromall® con contenitori in vetro satinato

Made of stainless steel and Cromall® with frosted glass containers

Réalisée en acier inoxydable et Cromall® avec boîtiers en verre satiné

Hergestellt aus Edelstahl und Cromall® mit Behältern aus satiniertem Glas

Realizada en acero inoxidable y Cromall® con contenedores en cristal satinado

Изготовлено из нержавеющей стали и Cromall® с ёмкостями из матового стекла

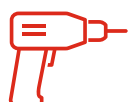

Con viti

With screws



Con colla

With glue



GARANZIA  
WARRANTY

(Venduta a parte  
Sold seperately)



13  
Cromato  
Chromed



14  
Nero matt  
Matt black

Stelvio.

SERIE DA MURO  
Wall series



SERIE DA MURO. WALL LINES.

**GEDY**

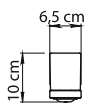
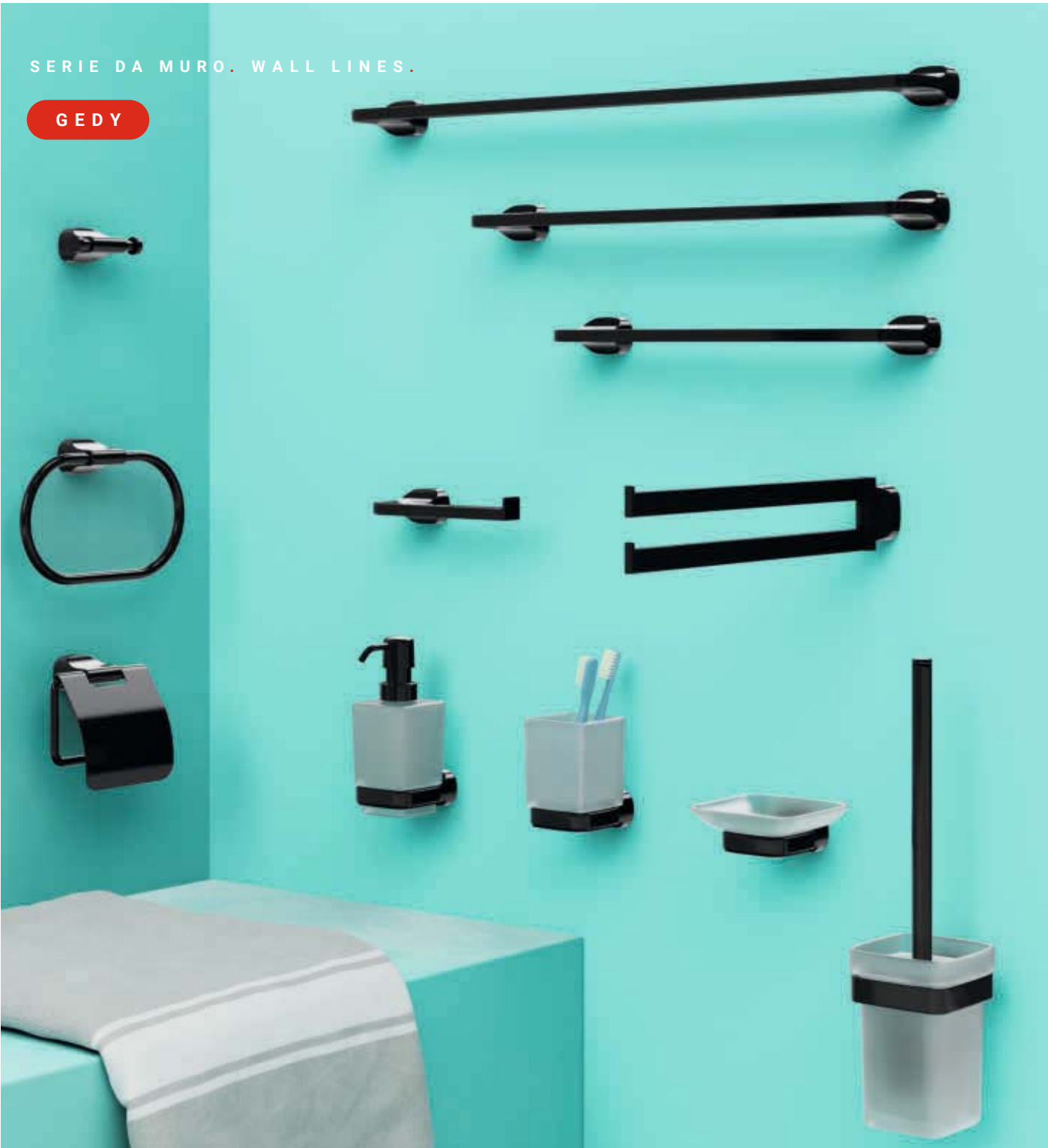

**ST10**

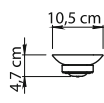

**ST11**

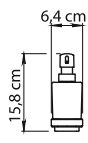

**ST80**

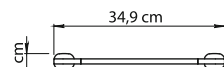

**ST21-35**

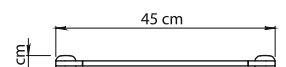

**ST21-45**

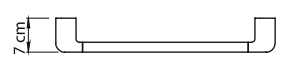
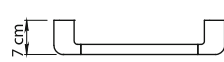
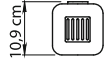





Stelvio.



Solo con viti  
Only with screws

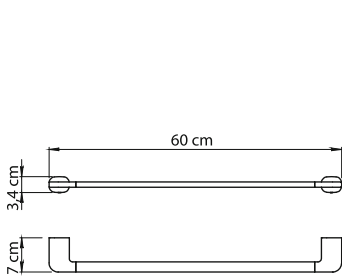

ST21-60

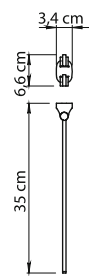

ST23

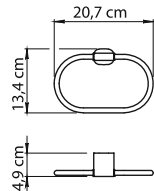

ST70

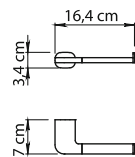

ST24

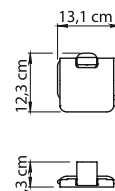

ST25

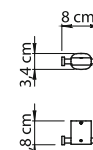

ST26

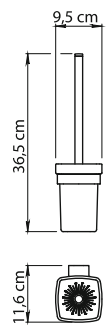

ST33-03

GEDY

## Tonale.

NEW

**Realizzata in acciaio inox e Cromall® con contenitori in vetro satinato**

Made of stainless steel and Cromall® with frosted glass containers

Réalisée en acier inoxydable et Cromall® avec boîtiers en verre satiné

Hergestellt aus Edelstahl und Cromall® mit Behältern aus satiniertem Glas

Realizada en acero inoxidable y Cromall® con contenedores en cristal satinado

Изготовлено из нержавеющей стали и Cromall® с ёмкостями из матового стекла

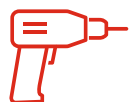

Con viti

With screws



GARANZIA

WARRANTY



13  
**Cromato**  
Chromed



88  
**Oro matt**  
Matt gold



Tonale.

SERIE DA MURO  
Wall series



SERIE DA MURO. WALL LINES.

GEDY

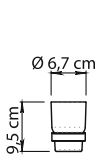

TN10

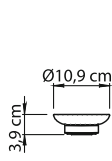

TN11

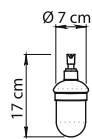

TN80

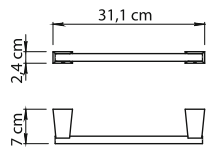

TN21-30

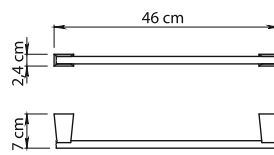

TN21-45

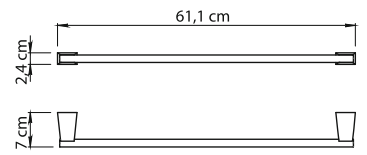

TN21-60

# Tonale.

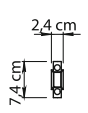

**TN23**

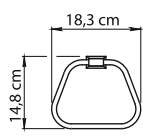

**TN70**

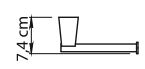
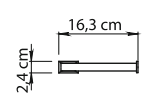

**TN24**

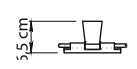
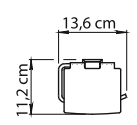

**TN25**

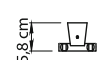
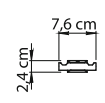

**TN26**

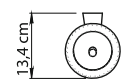
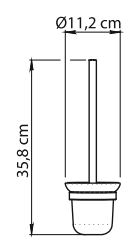

**TN33-03**

GEDY

## Felce.

### Realizzata in acciaio inox e Cromall® con contenitori in vetro satinato

Made of stainless steel and Cromall® with frosted glass containers

Réalisée en acier inoxydable et Cromall® avec boîtiers en verre satiné

Hergestellt aus Edelstahl und Cromall® mit Behältern aus satiniertem Glas

Realizada en acero inoxidable y Cromall® con contenedores en cristal satinado

Изготовлено из нержавеющей стали и Cromall® с ёмкостями из матового стекла

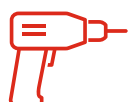

Con viti

With screws



Con colla

With glue



GARANZIA  
WARRANTY

(Venduta a parte  
Sold seperately)



13  
Cromato  
Chromed

Felce.

SERIE DA MURO  
Wall series



**GEDY**



10 / 30

Lunghezza modificabile  
Adjustable length



10 / 50

Lunghezza modificabile  
Adjustable length



10 / 60

Lunghezza modificabile  
Adjustable length

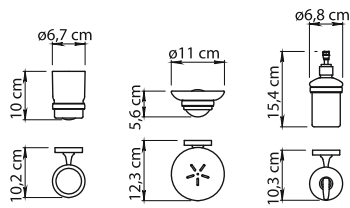

**FE10**

**FE11**

**FE81**

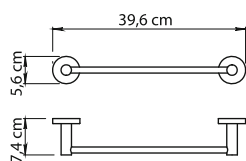

**FE21-35**

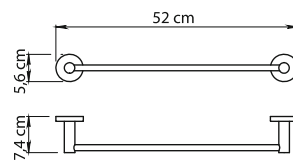

**FE21-45**

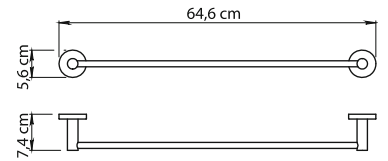

**FE21-60**





Solo con viti  
Only with screws

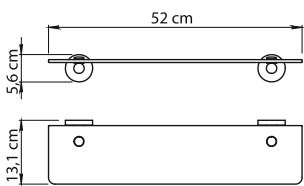

FE19-55

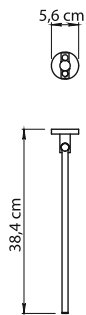

FE23

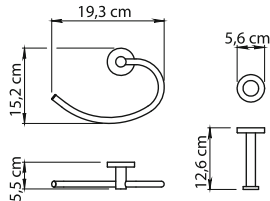

FE70

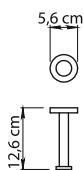

FE24

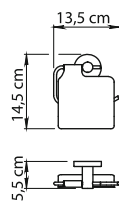

FE25

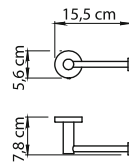

FE29

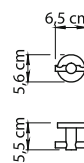

FE26



FE27

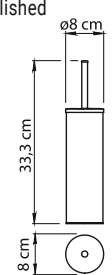

FE33

13  
Lucido  
Polished



GARANZIA  
WARRANTY

## Olimpo.

### Realizzata in acciaio inox e Cromall® con contenitori in vetro satinato

Made of stainless steel and Cromall® with frosted glass containers

Réalisée en acier inoxydable et Cromall® avec boîtiers en verre satiné

Hergestellt aus Edelstahl und Cromall® mit Behältern aus satiniertem Glas

Realizada en acero inoxidable y Cromall® con contenedores en cristal satinado

Изготовлено из нержавеющей стали и Cromall® с ёмкостями из матового стекла

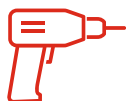

Con viti  
With screws



Con colla  
With glue  

---

**(Venduta a parte  
Sold seperately)**



**GARANZIA  
WARRANTY**



13  
**Cromato**  
Chromed



Olimpo.

SERIE DA MURO  
Wall series



**GEDY**

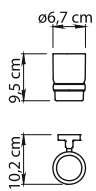
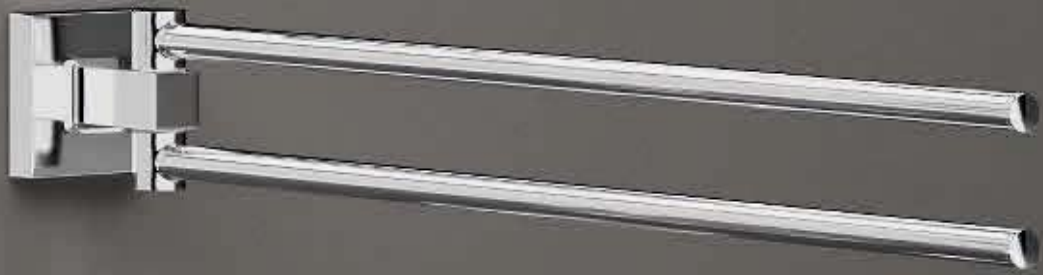

**OI10**

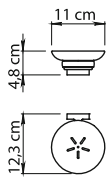

**OI11**

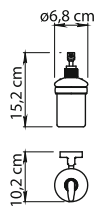

**OI81**



**10 / 30**  
Lunghezza modificabile  
Adjustable length

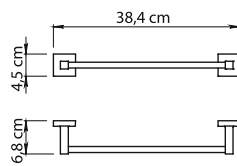

**OI21-35**



**10 / 45**  
Lunghezza modificabile  
Adjustable length

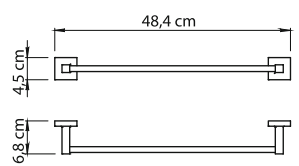

**OI21-45**



10 / 60  
Lunghezza modificabile  
Adjustable length



Solo con viti  
Only with screws

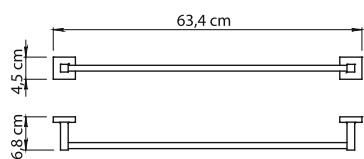

OI21-60

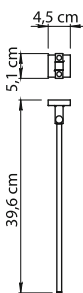

OI23

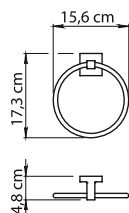

OI70

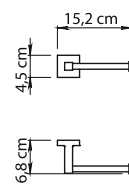

OI24

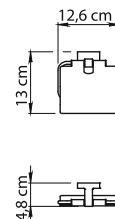

OI25

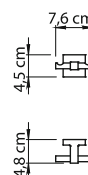

OI26

## Teide.

### Realizzata in acciaio inox e Cromall® con contenitori in vetro satinato

Made of stainless steel and Cromall® with frosted glass containers

Réalisée en acier inoxydable et Cromall® avec boîtiers en verre satiné

Hergestellt aus Edelstahl und Cromall® mit Behältern aus satiniertem Glas

Realizada en acero inoxidable y Cromall® con contenedores en cristal satinado

Изготовлено из нержавеющей стали и Cromall® с ёмкостями из матового стекла

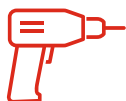

Con viti

With screws



Con biadesivo

With double sided

tape



GARANZIA

WARRANTY



13

Cromato  
Chromed



14

Nero matt  
Matt black

Teide

SERIE DA MURO  
Wall series



SERIE DA MURO . WALL LINES .

GEDY

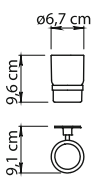
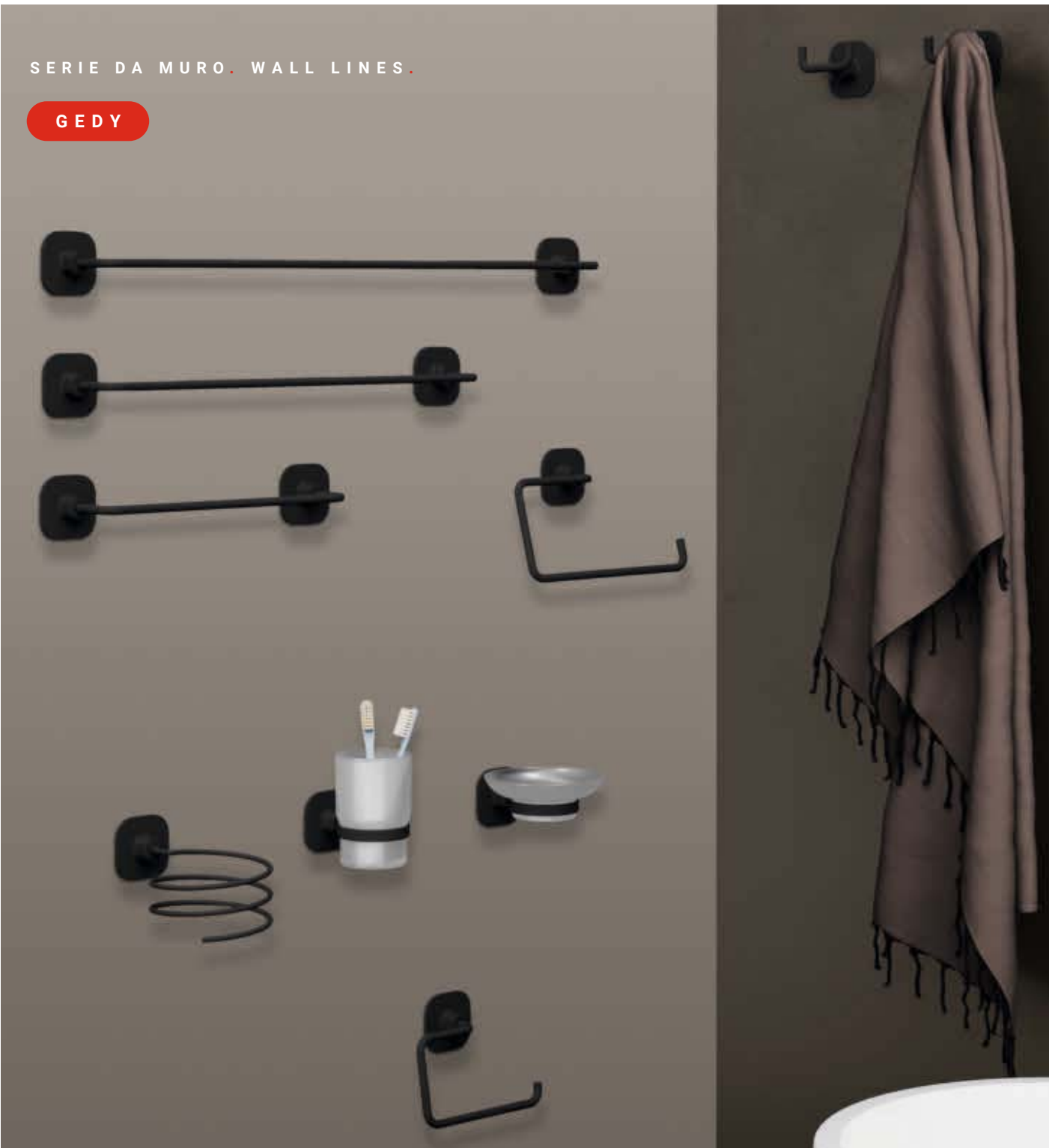

TE10

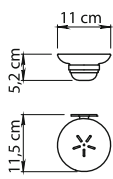

TE11

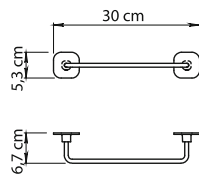

TE21-30

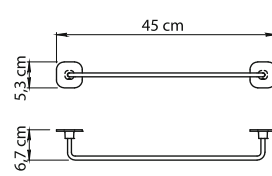

TE21-45

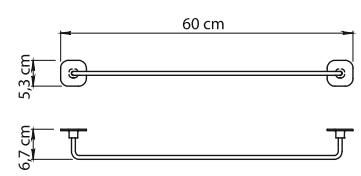

TE21-60



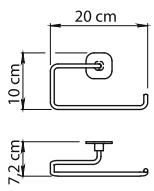

**TE70**

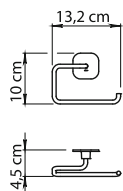

**TE24**

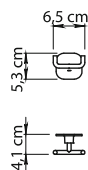

**TE26**

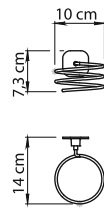

**TE55**

GEDY

## Cervino.

### Realizzata in acciaio inox e Cromall® con contenitori in vetro satinato

Made of stainless steel and Cromall® with frosted glass containers

Réalisée en acier inoxydable et Cromall® avec boîtiers en verre satiné

Hergestellt aus Edelstahl und Cromall® mit Behältern aus satiniertem Glas

Realizada en acero inoxidable y Cromall® con contenedores en cristal satinado

Изготовлено из нержавеющей стали и Cromall® с ёмкостями из матового стекла

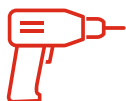

Con viti

With screws



Con colla

With glue

(Venduta a parte  
Sold seperately)



GARANZIA  
WARRANTY



13  
Cromato  
Chromed



Cervino.

SERIE DA MURO  
Wall series



SERIE DA MURO. WALL LINES.

**GEDY**

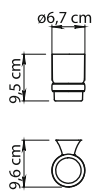

**CE10**

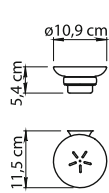

**CE11**

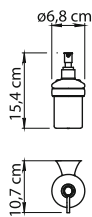

**CE80**



**10 / 30**  
Lunghezza modificabile  
Adjustable length

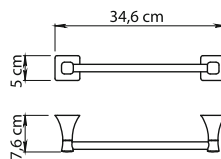

**CE21-35**



**10 / 40**  
Lunghezza modificabile  
Adjustable length

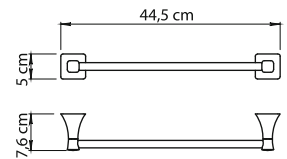

**CE21-45**



10 / 55  
Lunghezza modificabile  
Adjustable length

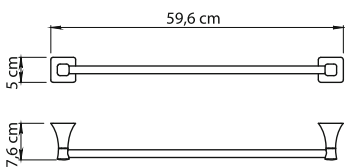

**CE21-60**

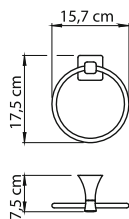

**CE70**

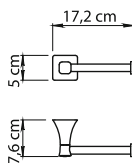

**CE24**

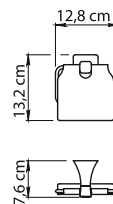

**CE25**

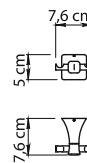

**CE26**

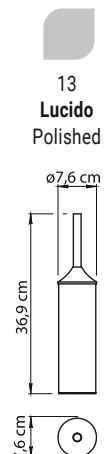

13  
Lucido  
Polished

**CE33**

## Everest.

### Realizzata in acciaio inox e Cromall® con contenitori in vetro satinato

Made of stainless steel and Cromall® with frosted glass containers

Réalisée en acier inoxydable et Cromall® avec boîtiers en verre satiné

Hergestellt aus Edelstahl und Cromall® mit Behältern aus satiniertem Glas

Realizada en acero inoxidable y Cromall® con contenedores en cristal satinado

Изготовлено из нержавеющей стали и Cromall® с ёмкостями из матового стекла

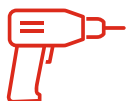

Con viti

With screws



Con colla

With glue

(Venduta a parte  
Sold seperately)



GARANZIA  
WARRANTY



13  
Cromato  
Chromed

Everest.

SERIE DA MURO  
Wall series

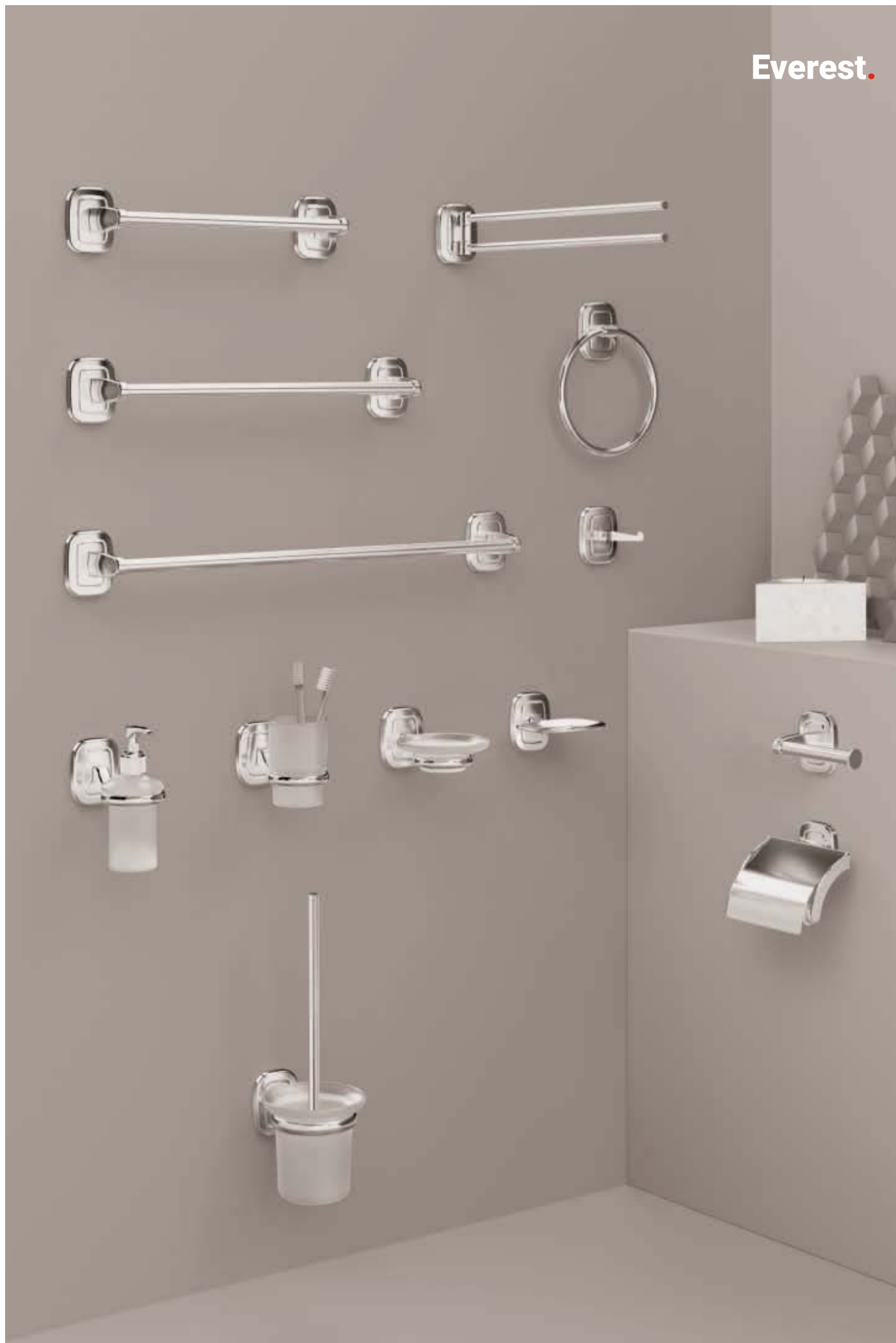

**GEDY**

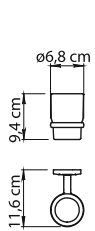

**EV10**

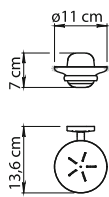

**EV11**

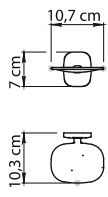

**EV12**

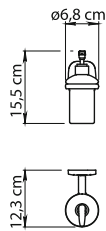

**EV80**



**10 / 35**  
Lunghezza modificabile  
Adjustable length

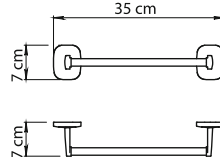

**EV21-35**



**10 / 45**  
Lunghezza modificabile  
Adjustable length

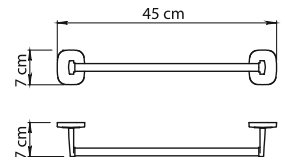

**EV21-45**

Everest



10/60  
Lunghezza modificabile  
Adjustable length

  
Solo con viti  
Only with screws

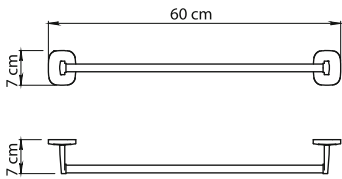

EV21-60

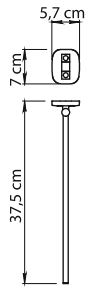

EV23

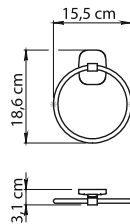

EV70

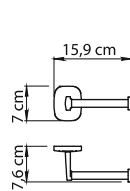

EV24

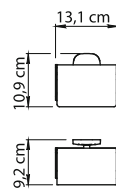

EV25

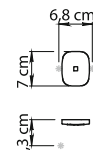

EV26

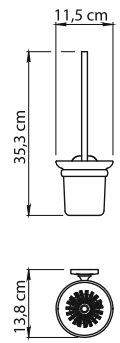

EV33-03

## K2.

### Realizzata in alluminio anodizzato e Cromall® con contenitori in vetro satinato

Made of anodized aluminium and Cromall® with frosted glass containers

Réalisée en aluminium anodisé et Cromall® avec boîtiers en verre satiné

Hergestellt aus Eloxiertes Aluminium und Cromall® mit Behältern aus satiniertem Glas

Realizada en aluminio anodizado y Cromall® con contenedores en cristal satinado

Изготовлено из анодированный алюминий и Cromall® с ёмкостями из матового стекла

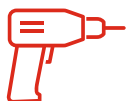

Con viti

With screws



Con colla

With glue



GARANZIA  
WARRANTY

(Venduta a parte  
Sold seperately)



13  
Cromato  
Chromed



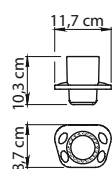
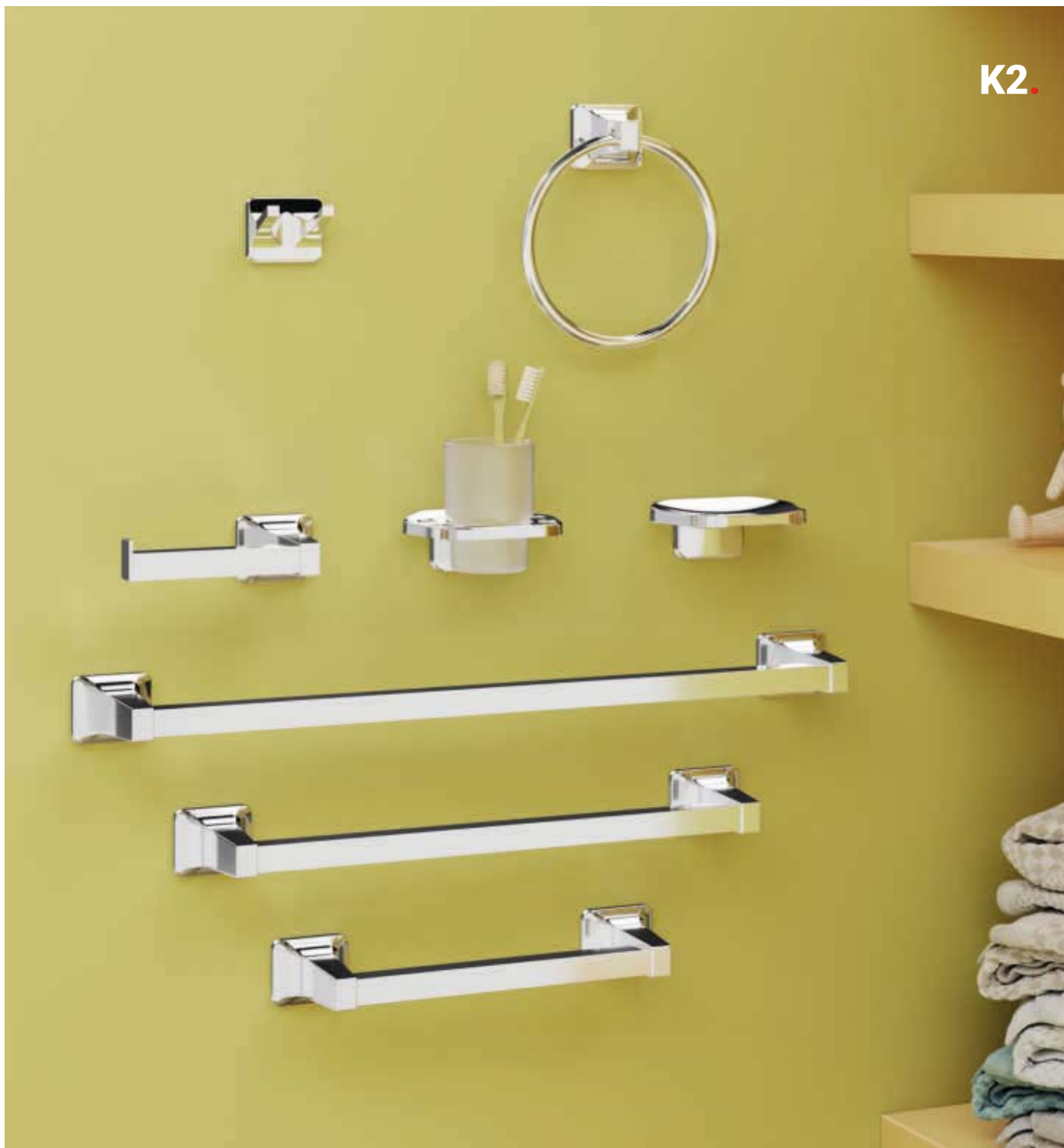

**KD10**



**10 / 30**  
Lunghezza modificabile  
Adjustable length



**10 / 45**  
Lunghezza modificabile  
Adjustable length



**10 / 60**  
Lunghezza modificabile  
Adjustable length

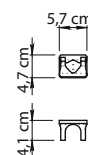

**KD26**

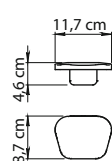

**KD12**

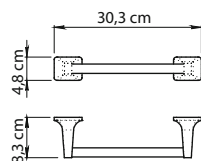

**KD21-30**

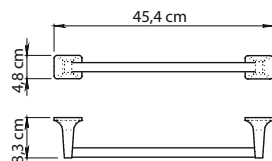

**KD21-45**

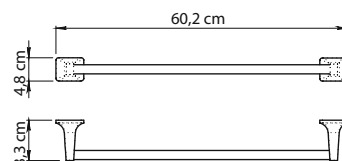

**KD21-60**

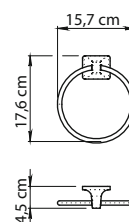

**KD70**

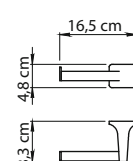

**KD24**

## Ventus.

**Realizzata in acciaio inox e ABS con contenitori in metacrilato trasparente**

Made of stainless steel and ABS with transparent methacrylate containers

Réalisée en acier inoxydable et ABS avec boîtiers en méthacrylate transparent

Hergestellt aus Edelstahl und ABS mit durchsichtigen Behältern aus Methacrylat

Realizada en acero inox y ABS con contenedores en metacrilato transparente

Изготовлено из нержавеющей стали и ABS с контейнерами из прозрачного метакрилата



Con ventosa

With suction cup

---

Solo su superfici lisce  
(specchi, piastrelle)  
For flat surfaces  
(mirrors, tiles) only



GARANZIA  
WARRANTY



13  
Cromato  
Chromed

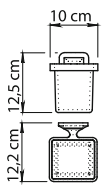

**VN10**



**10 / 35**  
Lunghezza modificabile  
Adjustable length



**10 / 50**  
Lunghezza modificabile  
Adjustable length



**10 / 65**  
Lunghezza modificabile  
Adjustable length



**VN26**



**VN24**

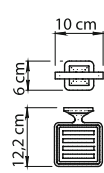

**VN11**

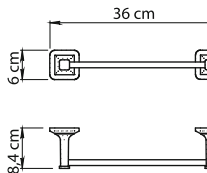

**VN21-30**

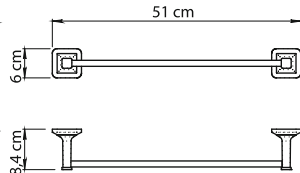

**VN21-45**

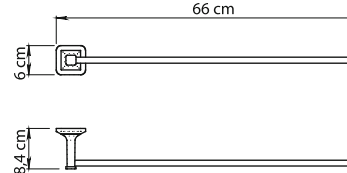

**VN21-60**

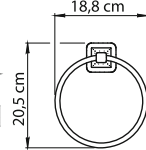

**VN70**

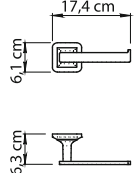

GEDY

## Genziana.

**Realizzata in acciaio inox e Cromall® con contenitori in vetro satinato**

Made of stainless steel and Cromall® with frosted glass containers

Réalisée en acier inoxydable et Cromall® avec boîtiers en verre satiné

Hergestellt aus Edelstahl und Cromall® mit Behältern aus satiniertem Glas

Realizada en acero inoxidable y Cromall® con contenedores en cristal satinado

Изготовлено из нержавеющей стали и Cromall® с ёмкостями из матового стекла

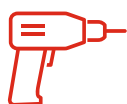

Con viti  
With screws



GARANZIA  
WARRANTY



13  
Cromato  
Chromed



02  
Bianco  
White

# Genziana

SERIE DA MURO  
Wall series



SERIE DA MURO . WALL LINES .

GEDY



13  
solo - only

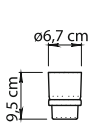

GE10

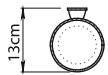
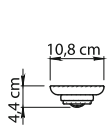

GE11

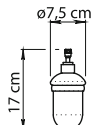

GE80

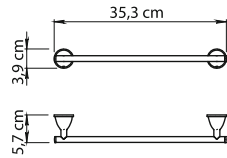

GE21-35

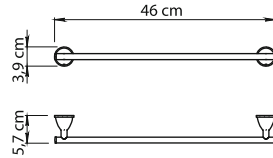

GE21-45

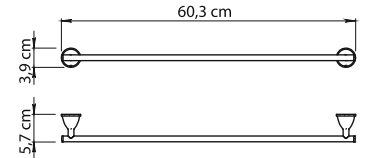

GE21-60



    
 Vetro temperato  
 Tempered glass  
 13  
 solo - only

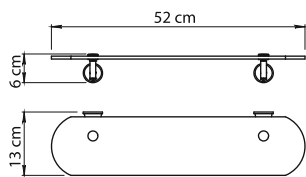

GE19-55

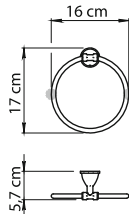

GE70

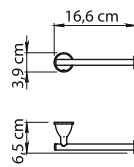

GE24

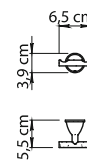

GE26



GE33

   
 02 **Bianco** 13 **Lucido**  
 White Polished

  
 2  
 YEARS  
 GARANZIA  
 WARRANTY

GEDY

## Set Ficus.



**Realizzato in metallo e Cromall® con contenitori in vetro satinato**

Made of metal and Cromall® with frosted glass containers

Réalisée en métal et Cromall® avec boîtiers en verre satiné

Hergestellt aus Metall und Cromall® mit Behältern aus satiniertem Glas

Realizada en metal y Cromall® con contenedores en cristal satinado

Изготовлено из металла и Cromall® с ёмкостями из матового стекла

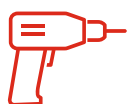

Con viti

With screws



**GARANZIA  
WARRANTY**



13

**Cromato-lucido**  
Chromed-polished



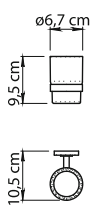
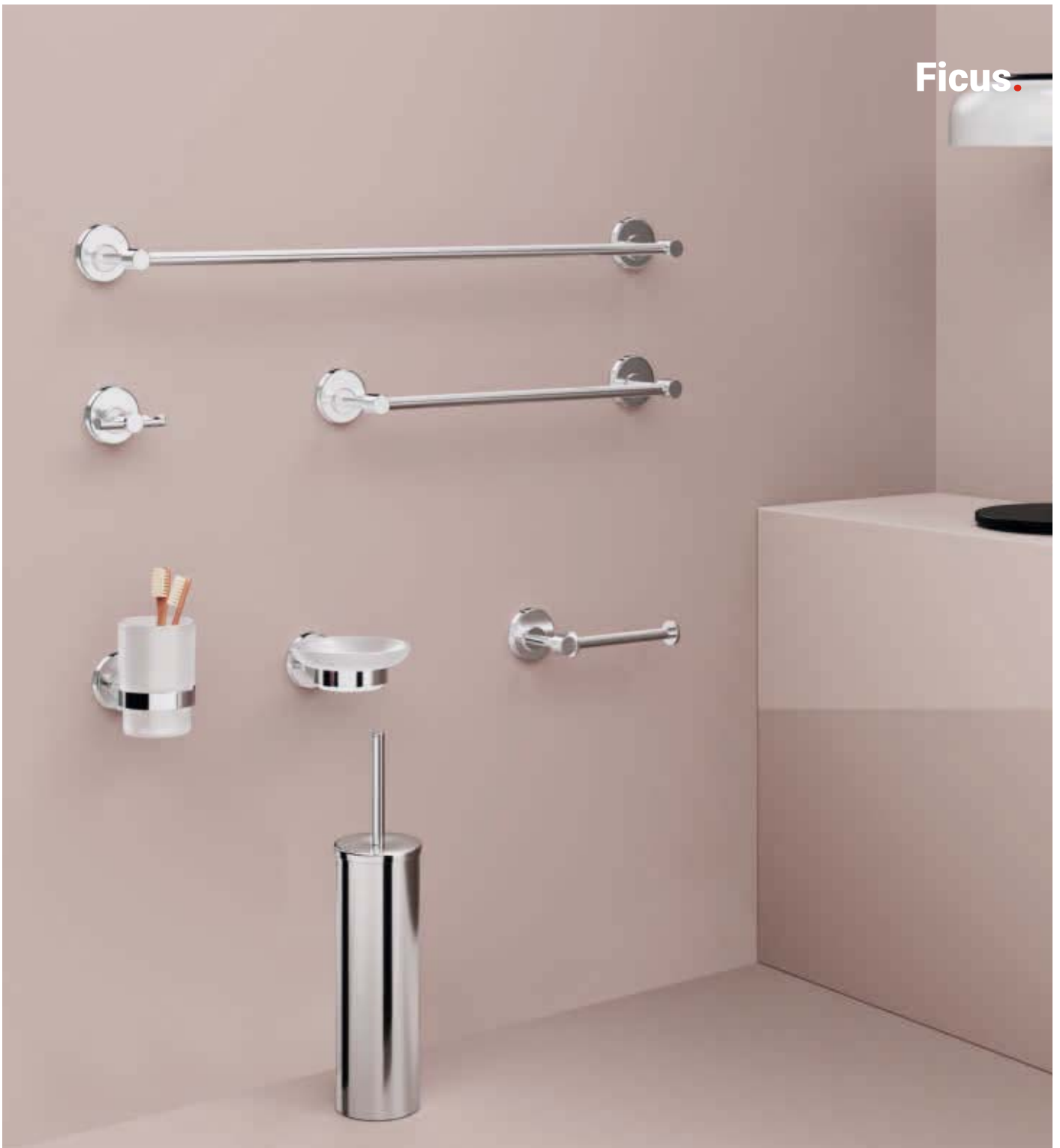

**FI10**

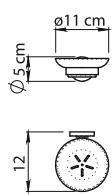

**FI11**

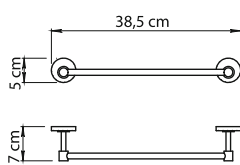

**FI21-35**

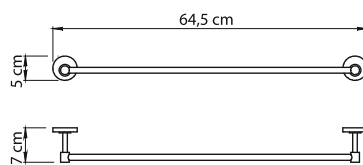

**FI21-60**

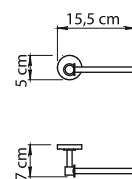

**FI24**

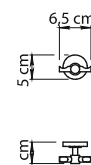

**FI26**

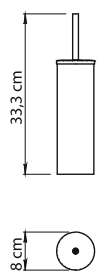

**FI33**

## Hot.

### Realizzata in metallo e resine termoplastiche

Made of metal and thermoplastic resins

Réalisée en métal et en résine thermoplastique

Hergestellt aus Metall und Kunststoff

Realizada en metal y resinas termoplásticas

Изготовлено из металла и термопластичных смол



Con ventosa

With suction cup

Solo su superfici lisce  
(specchi, piastrelle)  
For flat surfaces  
(mirrors, tiles) only



GARANZIA  
WARRANTY



13  
Cromato  
Chromed



14  
Nero  
Black

Hot.

SERIE DA MURO  
Wall series



**GEDY**

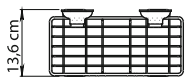
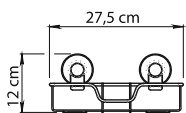

**H020**

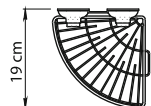
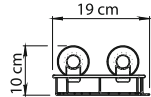

**H080**

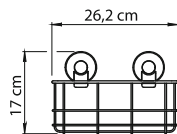

**H018**

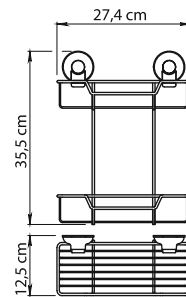

**H019**



13  
solo - only

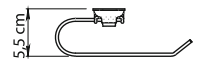
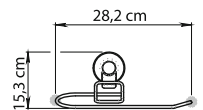

**H021-30**

Hot.



13  
solo - only

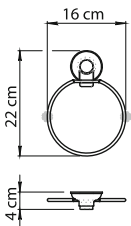

H070



14

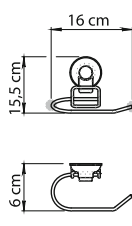

H024



H026



13  
solo - only

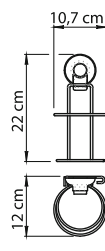

H052

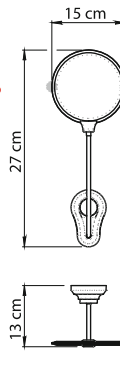

H008



13  
solo - only

Specchio  
orientabile  
Adjustable  
mirrore

## Darios.

### Realizzata in resine termoindurenti

Made of thermosetting resins

Réalisée en résine thermodurcissable

Hergestellt aus Duroplast

Realizada en resinas termoestables

Изготовлено из термореактивных смол

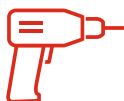

Con viti  
With screws



GARANZIA  
WARRANTY

100% MADE  
in Italy



02  
Bianco  
White

Realizzate in resine termoplastiche - Made of thermosetting resins \*

design Gianpietro Tonetti\*\*

# Darios.

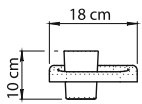

7210

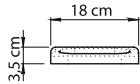

7211

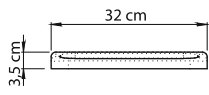

7218

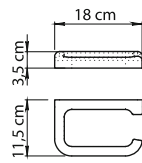

7224

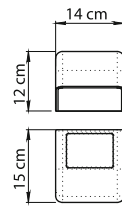

7225\*

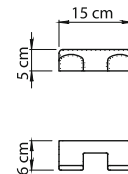

7226

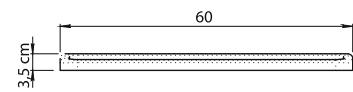

7221-60

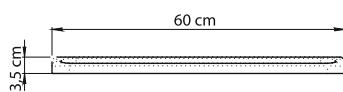

7219-60

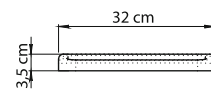

7221-30

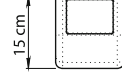
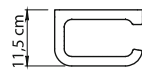
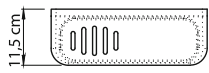
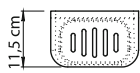
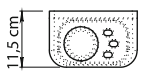

GARANZIA  
WARRANTY

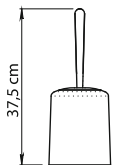

8034\*  
\*\*

SERIE DA MURO. WALL LINES.

GEDY

**2900.**

design Makio Hasuike

**Realizzata in resine termoplastiche**

Made of thermoplastic resins

Réalisée en résine thermoplastique

Hergestellt aus Kunststoff

Realizada en resinas termoplásticas

Изготовлено из термопластичных смол

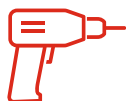

Con viti

With screws

100% MADE  
in **Italy**



02  
**Bianco**  
White



2900.

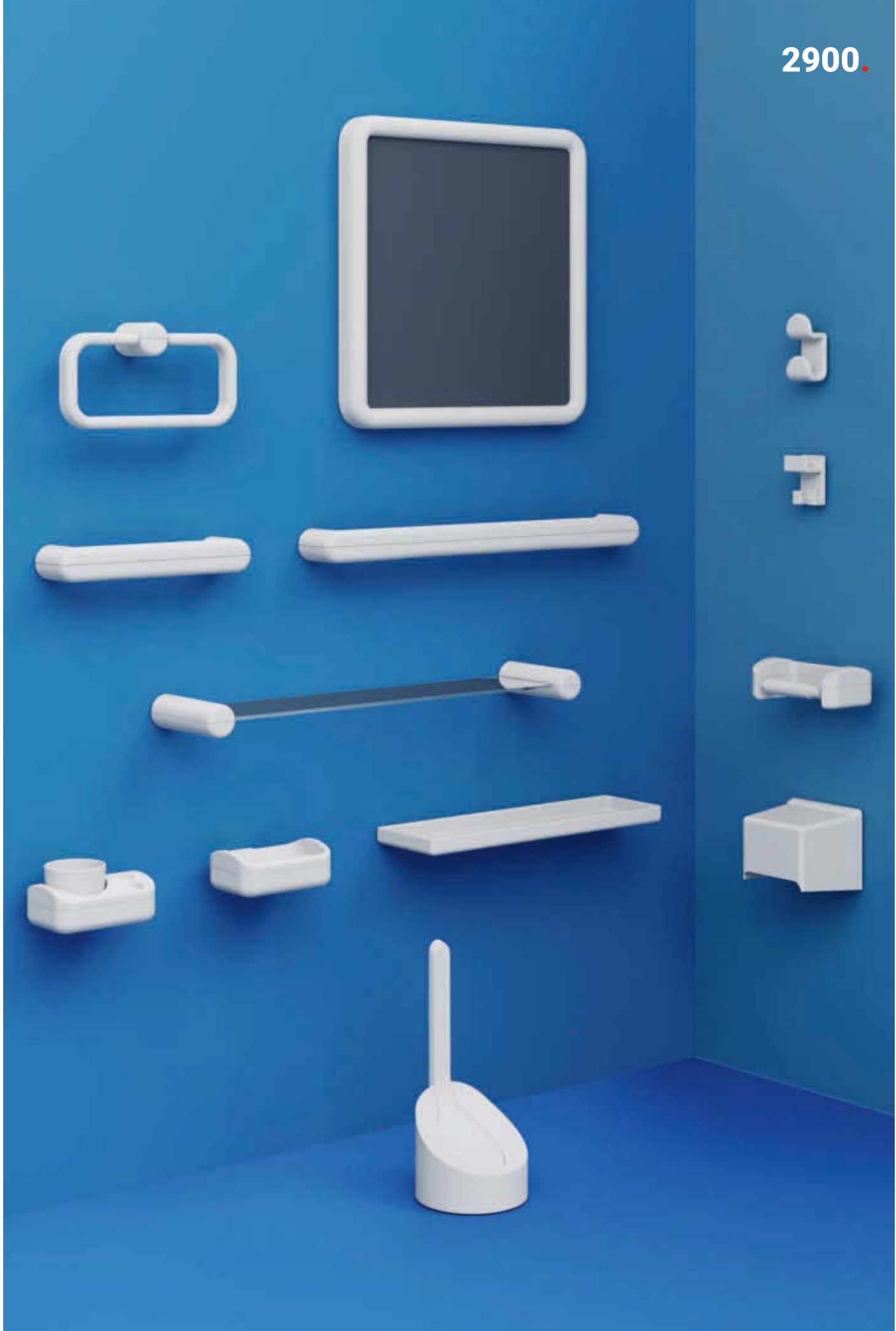

SERIE DA MURO . WALL LINES .

GEDY

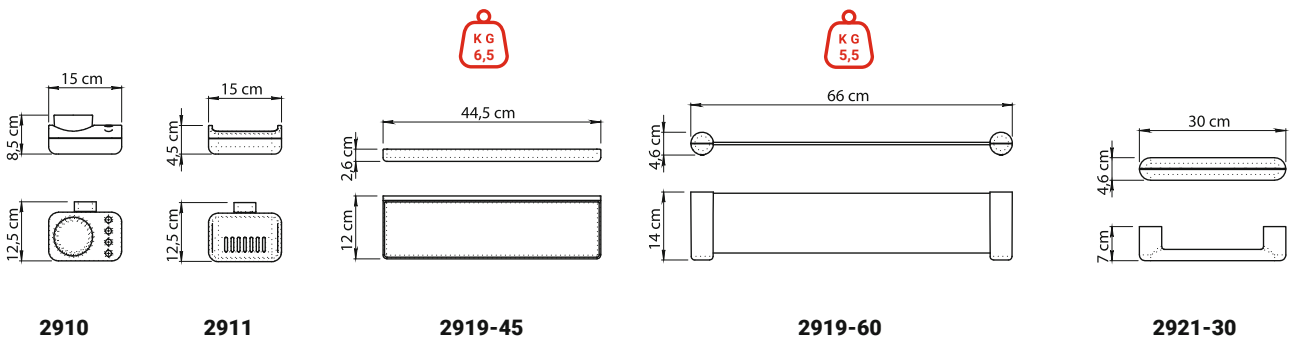

**MoMA** June 27, 1977  
In permanent Design Collection  
of the Museum of Modern Art  
in New York



**2900.**

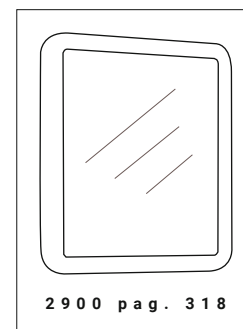
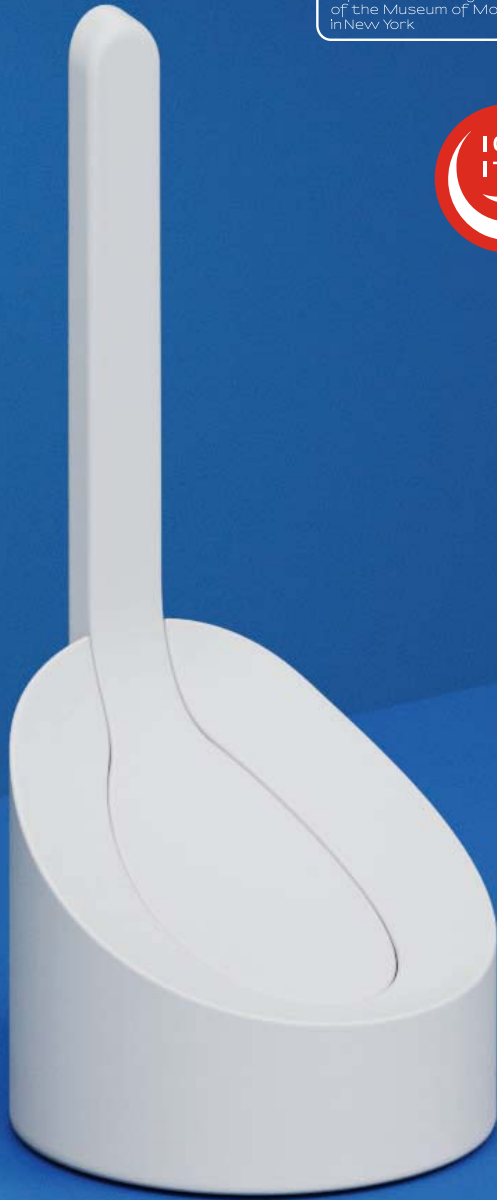

design **Ambrogio Rossari\*\***

design **Olaf Von Bohr\***

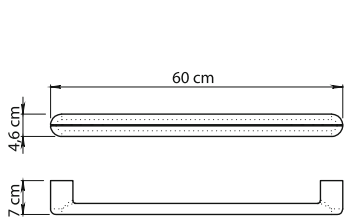

**2921-60**

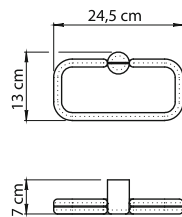

**2970**

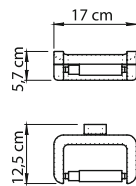

**2924**

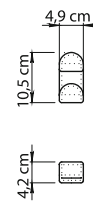

**6027\*\***

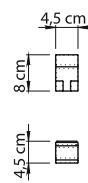

**5027\***

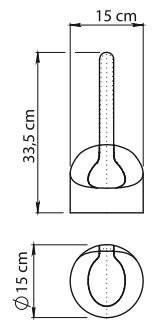

**2033**

GEDY

## Junior.

design Gianpietro Tonetti

### Realizzata in resine termoplastiche

Made of thermoplastic resins

Réalisée en résine thermoplastique

Hergestellt aus Kunststoff

Realizada en resinas termoplásticas

Изготовлено из термопластичных смол

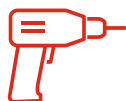

Con viti  
With screws



Con ventosa  
With suction cup

Solo su superfici lisce  
(specchi, piastrelle)  
For flat surfaces  
(mirrors, tiles) only



GARANZIA  
WARRANTY

100% MADE  
in Italy



02  
Bianco  
White

Junior

SERIE DA MURO  
Wall series



SERIE DA MURO WALL LINES

**GEDY**



**KG**  
7,5

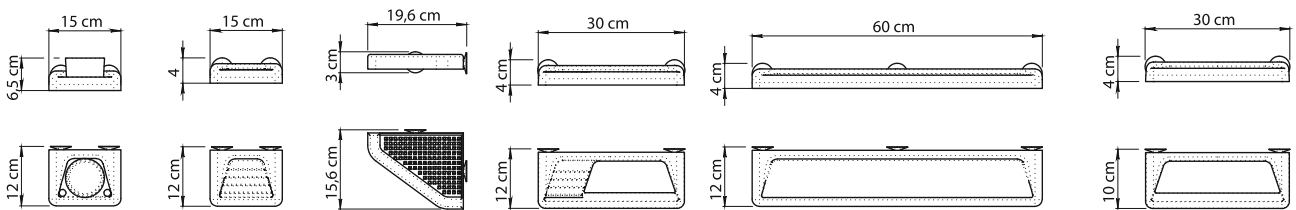

**8010**

**8011**

**8080**

**8012**

**8019-60**

**8021-30**



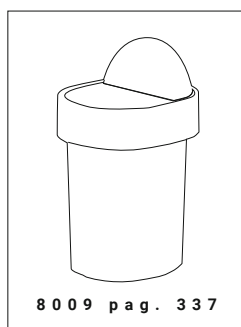
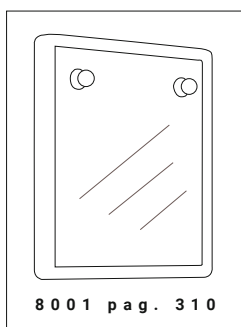

Solo con biadesivo o viti  
Only with double tape sided  
and screws\*



Solo con viti  
Only with screws\*\*

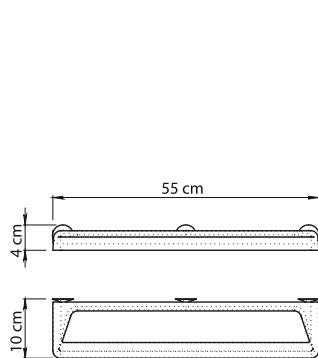

**8021-55**

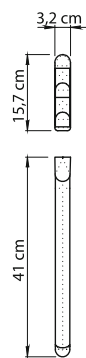

**8023\*\***

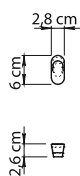

**8026\***

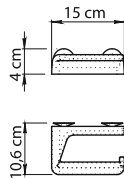

**8024**

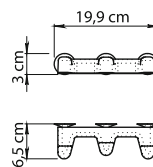

**8028**

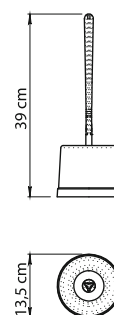

**8033**

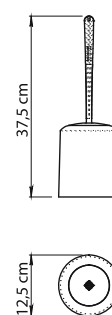

**8034**

## Vesuvio.

### Realizzata in resine termoplastiche

Made of thermoplastic resins

Réalisée en résine thermoplastique

Hergestellt aus Kunststoff

Realizada en resinas termoplásticas

Изготовлено из термопластичных смол



Con ventosa

With suction cup

Solo su superfici lisce  
(specchi, piastrelle)  
For flat surfaces  
(mirrors, tiles) only



GARANZIA  
WARRANTY



02  
Bianco  
White





10/53

Attacco girevole Lunghezza estensibile  
Swivel wall plate Adjustable length

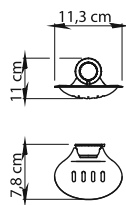

VS11

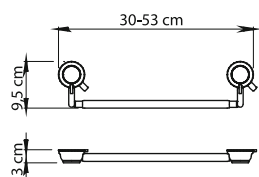

VS21-30

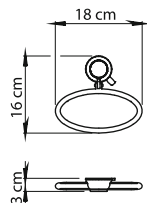

VS70

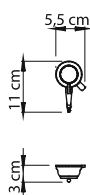

VS28

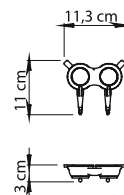

VS26

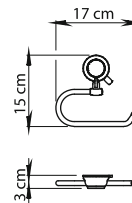

VS24

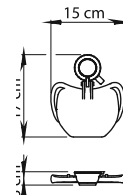

VS25

GEDY

bamboom

## Himalaya.

NEW

### Realizzata in bambù

Made of bamboo

Réalisée en bambou

Hergestellt aus Bambus

Realizada en bambù

Изготовлено из бамбука



Con viti

With screws



Natural



Bambù

Bamboo



Save

the planet



GARANZIA

WARRANTY



35

Naturale  
Natural

# Himalaya.

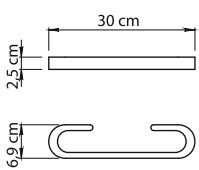

**HY21-30**

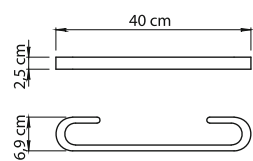

**HY21-40**

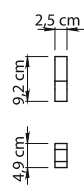

**HY26**  
2 pz - 2 pcs

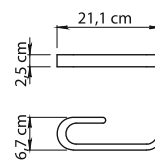

**HY70**

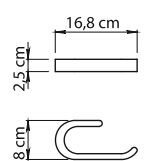

**HY24**



SERIE DA  
APPOGGIO

Table top  
series





SERIE DA APPOGGIO. TABLE TOP SERIES.

TOP DESIGN

## Lounge.

**Realizzata in alluminio con contenitori in vetro satinato**

Made of aluminium with frosted glass containers

Réalisée en aluminium avec boîtiers en verre satiné

Hergestellt aus Aluminium mit Behältern aus satiniertem Glas

Realizada en aluminio con contenedores en cristal satinado

Изготовлено из латуни и ёмкостями из матового стекла



GARANZIA

WARRANTY



13

Cromato  
Chromed



14

Nero matt  
Matt black



**5498**

L7 x P7 x H10 cm



**5451**

L12 x P12 x H5 cm



**5455**

L6,8 x P9 x H15,9 cm

SERIE DA APPOGGIO. TABLE TOP SERIES.

GEDY

## Elettra.

Realizzata in acciaio inox

Made of stainless steel

Réalisée en acier inoxydable

Hergestellt aus Edelstahl

Realizada en acero inox

Изготовлено из нержавеющей стали



15  
Rame  
Copper



EE98

ø 6,3 x H11,3 cm



EE11

L11 x P8 x H2 cm



EE80

ø 6,3 x H19 cm



EE33

ø 8 x H46,8 cm

SERIE DA APPOGGIO. TABLE TOP SERIES.

GEDY

## Polaris.



13  
Lucido  
Polished

**Realizzata in acciaio inox**

Made of stainless steel

Réalisée en acier inoxydable

Hergestellt aus Edelstahl

Realizada en acero inox

Изготовлено из нержавеющей стали



**PL98**

L10 x P4,6 x H10 cm



**PL11**

L12,7 x P10 x H2,6 cm



**PL80**

L10 x P4,6 x H15,5 cm



**PL33**

L12,5 x P9,5 x H39,4 cm



SERIE DA APPOGGIO. TABLE TOP SERIES.

GEDY

## Nemesia.

Realizzata in acciaio inox

Made of stainless steel

Réalisée en acier inoxydable

Hergestellt aus Edelstahl

Realizada en acero inox

Изготовлено из нержавеющей стали



13  
Lucido  
Polished



NE98

L6 x P6 x H10 cm



NE11

L11,8 x P11,8 x H2 cm



NE81

L6 x P6 x H18 cm



NE33

L9 x P9 x H38 cm



NE33 03

L9 x P9 x H38 cm

SERIE DA APPOGGIO. TABLE TOP SERIES.

GEDY

## Betty.



13  
Cromato  
Chromed

**Realizzata in acciaio inox e resine termoplastiche**

Made of stainless steel and thermoplastic resins

Réalisée en acier inoxydable et résine thermoplastique

Hergestellt aus Edelstahl und Kunststoff

Realizada en acero inox y resinas termoplásticas

Изготовлено из нержавеющей стали и термопластиченых смол



**BT98**

ø 6,4 x H12,5 cm



**BT11**

ø 12 x H3,2 cm



**BT81**

L8,5 x P6,4 x H18,5



**BT33**

ø 9,3 x H38 cm

SERIE DA APPOGGIO. TABLE TOP SERIES.

GEDY

## Primula.

**Realizzata in acciaio inox**

Made of stainless steel

Réalisée en acier inoxydable

Hergestellt aus Edelstahl

Realizada en acero inox

Изготовлено из нержавеющей стали



21

**Lucido/spazzolato**  
Polished/brushed

SERIE DA APPOGGIO  
Table top series



**PR98**

ø 7 x H10 cm



**PR11**

ø11,2 x H2 cm



**PR81**

ø5,5 x H19 cm



**PR33**

ø 10 x H38 cm

SERIE DA APPOGGIO. TABLE TOP SERIES.

GEDY

## Nigella.

Realizzata in acciaio inox

Made of stainless steel

Réalisée en acier inoxydable

Hergestellt aus Edelstahl

Realizada en acero inox

Изготовлено из нержавеющей стали



38  
Spazzolato  
Brushed



**NI98**

ø 9 x H10 cm



**NI11**

ø 11 x H2,1 cm



**NI81**

ø 9 x H15,5 cm



**NI33**

ø 12,5 x H38,6 cm

SERIE DA APPOGGIO. TABLE TOP SERIES.

GEDY

## Calipso.

### Realizzata in cemento

Made of concrete

Réalisée en béton

Hergestellt aus Zement

Realizada en cemento

Изготовлено из бетона



08  
Grigio  
Grey



**8798**

ø 7,7 x H11,3 cm



**8711**

L11,8 x P7,5 x H2,6 cm



**8780**

ø 8,2 x H17,6 cm



**8733**

ø 10 x H48,7 cm

SERIE DA APPOGGIO. TABLE TOP SERIES.

GEDY

## Giunone.

Realizzata in cemento

Made of concrete

Réalisée en béton

Hergestellt aus Zement

Realizada en cemento

Изготовлено из бетона



08  
Grigio  
Grey



**4198**

ø 8,2 x H9,3 cm



**4111**

ø 11,5 x H2,4 cm



**4180**

ø 8,2 x H17,5 cm



**4106**

L27,5 x P15,5 x H2,8 cm



**4133**

ø 10,3 x H46,5 cm

SERIE DA APPOGGIO. TABLE TOP SERIES.

bambocom®

GEDY

## Afrodite.

Realizzata in cemento e bambù

Made of concrete and bamboo

Réalisée en béton et bambou

Hergestellt aus Zement und Bambus

Realizada en cementoy bambú

Изготовлено из бетона и бамбука



Natural



Bambù

Bamboo



Save  
the planet



08  
Grigio  
Grey



4998

ø 7,5 x H11,5 cm



4911

L12,8 x P8,4 x H3 cm



4980

ø 7,6 x H17,2 cm



4906

L30,5 x P10,4 x H3,2 cm



4933

ø 9,3 x H47 cm

SERIE DA APPOGGIO. TABLE TOP SERIES.

bambocom®

GEDY

## Dafne.

### Realizzata in bambù

Made of bamboo

Réalisée en bambou

Hergestellt aus Bambus

Realizada en bambú

Изготовлено из бамбука



Natural



Bambù

Bamboo



Save

the planet



30

Noce

Walnut colour



**3998**

L8 x P8 x H13 cm



**3911**

L14 x P8 x H2,2 cm



**3980**

L8 x P8 x H18,5 cm



**3933**

L9,5 x P9,5 x H47 cm



SERIE DA APPOGGIO. TABLE TOP SERIES.

bambocom®

GEDY

## Altea.

### Realizzata in bambù

Made of bamboo

Réalisée en bambou

Hergestellt aus Bambus

Realizada en bambú

Изготовлено из бамбука



Natural



Bambù

Bamboo



Save  
the planet



35  
Naturale  
Natural



**AL98**

ø 7 x H12 cm



**AL11**

ø 11,7 x H2 cm



**AL80**

ø 7 x H17,2 cm



**AL33**

ø 8,5 x H47,5 cm

SERIE DA APPOGGIO. TABLE TOP SERIES.

bambocom®

GEDY

**Bonnie.**

NEW



**Realizzata in bambù**

Made of bamboo

Réalisée en bambou

Hergestellt aus Bambus

Realizada en bambú

Изготовлено из бамбука

Natural

Bambù

Bamboo

Save  
the planet

41  
Naturale/nero matt  
Natural/matt black



35  
Naturale  
Natural



**BN98**

L7,4 x P7,4 x H11 cm



35  
Naturale  
Natural



**BN11**

L13,4 x P9,6 x H2,5 cm



**BN80**

L7,4 x P7,4 x H16,8 cm



**BN33**

L10 x P10 x H36,5 cm



**BN34**

L10 x P10 x H39,5 cm

SERIE DA APPOGGIO. TABLE TOP SERIES.

GEDY

**Cixi.**

**NEW**

design Eric Bevilacqua

**Realizzata in porcellana**

Made of porcelain

Réalisée en porcelaine

Hergestellt aus Porzellan

Realizada en porcelana

Изготовлено из фарфор

PORCELLANA  
PORCELAIN



89  
**Bianco/Blu**  
White/Blue

SERIE DA APPOGGIO  
Table top series



**CX98**

L7,5 x P7,5 x H11,5 cm



**CX11**

L10,5 x P10,5 x H3 cm



**CX81**

L7,5 x P9,5 x H17 cm



**CX33**

L11,5 x P11,5 x H44,5 cm

SERIE DA APPOGGIO. TABLE TOP SERIES.

GEDY

## Myosotis.

Realizzata in ceramica e vetro

Made of pottery and glass

Réalisée en céramique et verre

Hergestellt aus Keramik und Glas

Realizada en cerámica y cristal

Изготовлено из керамики и стекла



03  
Crema/oro  
Cream/gold



73  
Argento  
Silver



**MY98**

ø 8,5 x H11,3 cm



**MY11**

L14 x P10 x H3,9 cm



**MY80**

ø 8,5 x H19 cm



**MY33**

ø 12,5 x H46 cm

SERIE DA APPOGGIO. TABLE TOP SERIES.

GEDY

## Marina.

**Realizzata in ceramica e madreperla**

Made of pottery and conch

Réalisée en céramique et nacre

Hergestellt aus Keramik und Perlmutter

Realizada en cerámica y nácar

Изготовлено из керамики и перламутра



03  
Crema  
Cream



**MR98**

ø 8,5 x H11,3 cm



**MR11**

L14 x P10 x H3,9 cm



**MR80**

ø 8,5 x H19 cm



**MR33**

ø 12,5 x H46 cm

SERIE DA APPOGGIO. TABLE TOP SERIES.

GEDY

## Amelie.

Realizzata in ceramica

Made of pottery

Réalisée en céramique

Hergestellt aus Keramik

Realizada en cerámica

Изготовлено из керамики



02  
Bianco  
White



**AM98**

L8 x P8 x H11,3 cm



**AM11**

L13,5 x P8 x H5,8 cm



**AM80**

L7,5 x P7,5 x H19 cm



**AM33**

L10,4 x P10,4 x H48,5 cm

SERIE DA APPOGGIO. TABLE TOP SERIES.

GEDY

## Lucrezia.

**Realizzata in ceramica**

Made of pottery

Réalisée en céramique

Hergestellt aus Keramik

Realizada en cerámica

Изготовлено из керамики



02  
**Bianco**  
White



**LC98**

L7 x P7 x H11 cm



**LC11**

L13 x P10 x H2,2 cm



**LC80**

L7 x P7 x H17,5 cm



**LC33**

L10 x P10 x H46 cm

SERIE DA APPOGGIO. TABLE TOP SERIES.

GEDY

## Clothilde.

Realizzata in ceramica

Made of pottery

Réalisée en céramique

Hergestellt aus Keramik

Realizada en cerámica

Изготовлено из керамики



02  
Bianco  
White



**CI98**

ø 7,2 x H11,8 cm



**CI11**

L12,7 x P8,8 x H2,9 cm



**CI80**

ø 7,2 x H20 cm



**CI33**

ø 9,6 x H46 cm



SERIE DA APPOGGIO. TABLE TOP SERIES.

GEDY

## Astrid.

Realizzata in ceramica

Made of pottery

Réalisée en céramique

Hergestellt aus Keramik

Realizada en cerámica

Изготовлено из керамики



73  
**Argento**  
Silver



87  
**Oro**  
Gold



**AD98**

ø 8,3 x H11 cm



**AD11**

ø 12 x H2,6 cm



**AD80**

ø 8,3 x H16,6 cm



**AD33**

ø 11,5 x H47 cm

SERIE DA APPOGGIO. TABLE TOP SERIES.

GEDY

## New Mizar.

### Realizzata in ceramica

Made of pottery

Réalisée en céramique

Hergestellt aus Keramik

Realizada en cerámica

Изготовлено из керамики



**NM98**

ø 6,4 x H10,8 cm



**NM11**

L12,3 x P9 x H3 cm



**NM80**

ø 6,4 x H19,2 cm



**NM33**

ø 9,7 x H47,5 cm



08  
**Grigio**  
Grey



52  
**Tortora**  
Turtledove grey



66  
**Tortora chiaro**  
Light  
turtledove grey



SERIE DA APPOGGIO. TABLE TOP SERIES.

GEDY

## Lucy.



02  
Bianco  
White

### Realizzata in ceramica

Made of pottery

Réalisée en céramique

Hergestellt aus Keramik

Realizada en cerámica

Изготовлено из керамики



**LY98**

L7,3 x P7,3 x H10,3 cm



**LY11**

L12 x P8,2 x H3 cm



**LY80**

L7,3 x P7,3 x H17,5 cm



**LY33**

L9,7 x P9,7 x H47 cm

SERIE DA APPOGGIO. TABLE TOP SERIES.

GEDY

## Catherine.

Realizzata in ceramica

Made of pottery

Réalisée en céramique

Hergestellt aus Keramik

Realizada en cerámica

Изготовлено из керамики



02  
Bianco  
White



CT98

ø 7,7 x H12 cm



CT11

L13 x P7,8 x H1,8 cm



CT80

ø 7,7 x H19 cm



CT33

ø 9,8 x H40 cm

SERIE DA APPOGGIO. TABLE TOP SERIES.

GEDY

## New Martina.

Realizzata in ceramica

Made of pottery

Réalisée en céramique

Hergestellt aus Keramik

Realizada en cerámica

Изготовлено из керамики



02  
Bianco  
White



73  
Argento  
Silver



**MT98**

L7,5 x P7,5 x H11 cm



**MT11**

L13 x P9 x H2,3 cm



**MT80**

L7,5 x P7,5 x H16 cm



**MT33**

L9 x P9 x H47 cm

SERIE DA APPOGGIO. TABLE TOP SERIES.

GEDY

## Naomi.

Realizzata in ceramica

Made of pottery

Réalisée en céramique

Hergestellt aus Keramik

Realizada en cerámica

Изготовлено из керамики



08  
Grigio  
Grey



14  
Nero  
Black



**N098**

ø 7,5 x H11,5 cm



**N011**

L13 x P9 x H2,5 cm



**N080**

ø 7,5 x H18,5 cm



**N033**

ø 9 x H45,5 cm

SERIE DA APPOGGIO. TABLE TOP SERIES.

GEDY

## Marika.

### Realizzata in ceramica

Made of pottery

Réalisée en céramique

Hergestellt aus Keramik

Realizada en cerámica

Изготовлено из керамики



**MK98**

ø 8 x H11,6 cm



**MK11**

L12 x P8,3 x H3 cm



**MK80**

ø 8 x H18 cm



**MK33**

ø 10,2 x H45 cm





02  
**Bianco**  
White



07  
**Verde salvia**  
Green sage



08  
**Grigio**  
Grey



SERIE DA APPOGGIO. TABLE TOP SERIES.

GEDY

## Vivienne.

### Realizzata in ceramica

Made of pottery

Réalisée en céramique

Hergestellt aus Keramik

Realizada en cerámica

Изготовлено из керамики



02  
Bianco  
White



05  
Blu  
Blue



**VV98**

L9,5 x P6 x H10,5 cm



**VV11**

L13 x P8,4 x H3,2 cm



**VV80**

L8,7 x P6 x H18 cm



**VV33**

L9 x P9 x H47 cm

SERIE DA APPOGGIO. TABLE TOP SERIES.

GEDY

**Ilary.**

**Realizzata in ceramica e sughero**

Made of pottery and cork

Réalisée en céramique et liège

Hergestellt aus Keramik und Kork

Realizada en cerámica y corcho

Изготовлено из керамики и пробки



02  
**Bianco**  
White



14  
**Nero matt**  
Matt black



**IL98**

ø 7 x H10,5 cm



**IL11**

L13 x P9,5 x H3 cm



**IL80**

ø 7 x H17 cm



**IL33**

ø 8,8 x H46,5 cm

SERIE DA APPOGGIO. TABLE TOP SERIES.

GEDY

## Chantal.

Realizzata in ceramica

Made of pottery

Réalisée en céramique

Hergestellt aus Keramik

Realizada en cerámica

Изготовлено из керамики



14  
Nero matt  
Matt black



**CN98**

ø 7 x H12 cm



**CN11**

L12,8 x P8,3 x H2,5 cm



**CN80**

ø 7 x H20,6 cm



**CN33**

ø 11,5 x H46,5 cm

SERIE DA APPOGGIO. TABLE TOP SERIES.

GEDY

## Sabina.

Realizzata in ceramica

Made of pottery

Réalisée en céramique

Hergestellt aus Keramik

Realizada en cerámica

Изготовлено из керамики



27

Acquamarina  
Aquamarine



**SA98**

ø 7,5 x H11 cm



**SA11**

ø 12 x H2 cm



**SA80**

ø 7,5 x H19 cm



**SA33**

ø 9,3 x H46 cm

SERIE DA APPOGGIO. TABLE TOP SERIES.

GEDY

**Wilma.**

NEW

**Realizzata in ceramica**

Made of pottery

Réalisée en céramique

Hergestellt aus Keramik

Realizada en cerámica

Изготовлено из керамики



07  
Verde salvia  
Sage green



**WL98**

ø 10 x H10 cm



**WL11**

ø 12,2 x H3 cm



**WL80**

ø 10 x H15,5 cm



**WL03**

ø 9,5 x H12,5 cm



**WL33**

ø 13 x H41 cm

SERIE DA APPOGGIO. TABLE TOP SERIES.

GEDY

## Azalea.

Realizzata in ceramica

Made of pottery

Réalisée en céramique

Hergestellt aus Keramik

Realizada en cerámica

Изготовлено из керамики



02  
Bianco  
White



79  
Lilla  
Lilac



**AZ98**

ø 9,8 x H13 cm



**AZ11**

L12,4 x P9 x H2,7 cm



**AZ80**

ø 10,2 x H17 cm



**AZ33**

ø 16,5 x H40,3 cm

SERIE DA APPOGGIO. TABLE TOP SERIES.

GEDY

## Alexia.



02  
Bianco  
White

### Realizzata in ceramica

Made of pottery

Réalisée en céramique

Hergestellt aus Keramik

Realizada en cerámica

Изготовлено из керамики



**AX98**

ø 9 x H10 cm



**AX11**

L14 x P6,5 x H2,5 cm



**AX80**

ø 9 x H17 cm



**AX33**

ø 12,5 x H36,5 cm



SERIE DA APPOGGIO. TABLE TOP SERIES.

GEDY

## Dalia.

### Realizzata in ceramica

Made of pottery

Réalisée en céramique

Hergestellt aus Keramik

Realizada en cerámica

Изготовлено из керамики



02  
Bianco  
White



**DA98**

ø 8,1 x H10,6 cm



**DA11**

ø 12,5 x H3,2 cm



**DA80**

ø 9 x H17,8 cm



**DA33**

ø 12,5 x H38 cm

SERIE DA APPOGGIO. TABLE TOP SERIES.

GEDY

## Petunia.



02  
Bianco  
White

**Realizzata in ceramica e acciaio inox**

Made of pottery and stainless steel

Réalisée en céramique et acier inoxydable

Hergestellt aus Keramik und Edelstahl

Realizada en cerámica y acero inox

Изготовлено из керамики и нержавеющей стали



**PE98**

ø 7,5 x H9,5 cm



**PE11**

L12,5 x P8,5 x H3,5 cm



**PE81**

ø 7,5 x H16,5 cm



**PE33**

ø 9 x H44,8 cm

SERIE DA APPOGGIO. TABLE TOP SERIES.

GEDY

## Karima.

Realizzata in ceramica

Made of pottery

Réalisée en céramique

Hergestellt aus Keramik

Realizada en cerámica

Изготовлено из керамики



02  
Bianco  
White



**KR98**

L7,5 x P7,5 x H11,6 cm



**KR11**

L13,5 x P9,7 x H2,7 cm



**KR80**

L7,5 x P7,5 x H17 cm



**KR33**

L10,6 x P10,6 x H43,5 cm

SERIE DA APPOGGIO. TABLE TOP SERIES.

GEDY

## Kelly.

### Realizzata in ceramica

Made of pottery

Réalisée en céramique

Hergestellt aus Keramik

Realizada en cerámica

Изготовлено из керамики



**KY98**

L7,2 x P7,2 x H10 cm



**KY11**

L10 x P10 x H3 cm



**KY80**

L7,2 x P7,2 x H16,3 cm



**KY33**

L10,3 x P10,3 x H40 cm



02  
**Bianco**  
White



08  
**Grigio**  
Grey



14  
**Nero**  
Black



66  
**Tortora chiaro**  
Light  
turtledove grey



87  
**Oro**  
Gold



SERIE DA APPOGGIO. TABLE TOP SERIES.

GEDY

## Verbena.

Realizzata in ceramica

Made of pottery

Réalisée en céramique

Hergestellt aus Keramik

Realizada en cerámica

Изготовлено из керамики



02  
Bianco  
White



**VE98**

L6,5 x P6,5 x H10 cm



**VE11**

L11,5 x P8,5 x H2,5 cm



**VE81**

L6,5 x P6,5 x H16,5 cm



**VE33**

L7,8 x P7,8 x H45,6 cm

SERIE DA APPOGGIO. TABLE TOP SERIES.

GEDY

## Nicole.

**Realizzata in vetro e silicone**

Made of glass and silicone

Réalisée en verre en silicone

Hergestellt aus Glas und Silikon

Realizada en cristal y silicona

Изготовлено из стекла и силикон



05  
**Blu**  
Blue



07  
**Verde**  
Green



**NC98**

ø 8,4 x H10,3 cm



**NC80**

ø 8,4 x H12,8 cm



**NC33**

ø 9,5 x H37 cm

SERIE DA APPOGGIO. TABLE TOP SERIES.

GEDY

## Corinne.

### Realizzata in vetro

Made of glass

Réalisée en verre

Hergestellt aus Glas

Realizada en cristal

Изготовлено из стекла



**CR98**

ø 7,9 x H9,8 cm



**CR11**

L13 x P9,3 x H2,4 cm



**CR80**

L8 x P8,9 x H15,6 cm



**CR33**

ø 9,1 x H35 cm





00  
**Trasparente  
fumé**  
Transparent  
smoked



05  
**Blu**  
Blue



07  
**Verde**  
Green



SERIE DA APPOGGIO. TABLE TOP SERIES.

GEDY

**Gioia.**

NEW

**Realizzata in vetro**

Made of glass

Réalisée en verre

Hergestellt aus Glas

Realizada en cristal

Изготовлено из стекла



**GO80 10**

ø 7,5 x H18,8 cm



**GO80 20**

ø 7,5 x H18,8 cm



**GO80 30**

ø 7,5 x H18,8 cm

SERIE DA APPOGGIO. TABLE TOP SERIES.

bambocom®

GEDY

## Ninfea.

Realizzata in resina e bambù

Made of resin and bamboo

Réalisée en résine et bambou

Hergestellt aus Harz und Bambus

Realizada en resina y bambú

Изготовлено из бамбука и смол



Natural



Bambù  
Bamboo



Save  
the planet



02  
Bianco matt  
Matt white



14  
Nero matt  
Matt black



1398

L12,8 x P5,6 x H8,5 cm



1311

L12,8 x P8,2 x H3 cm



1380

L12,8 x P5,6 x H15,7 cm



35  
Naturale  
Natural



1306

L29,7 x P15,2 x H2 cm



1333

L9,3 x P9,3 x H46,2 cm

SERIE DA APPOGGIO. TABLE TOP SERIES.

bambocom®

GEDY

Thea.

NEW

Realizzata in bambù e resina

Made of bamboo and resin

Réalisée en bambou et résine

Hergestellt aus Bambus und Harz

Realizada en bambú y resina

Изготовлено из бамбука и бамбука



Natural



Bambù

Bamboo



Save

the planet



47

Naturale/Verde  
Natural/Green



07  
Verde  
Green



TH98

ø 7,5 x H10,5 cm



TH11

ø 12 x H2,3 cm



TH80

ø 7,5 x P8,5 x H15 cm



TH03

ø 9,5 x H7,3 cm



TH06

L27,5 x P11,8 x H1,5 cm



TH33

ø 9,5 x H35 cm



35  
Naturale  
Natural

SERIE DA APPOGGIO. TABLE TOP SERIES.

GEDY

## Iside.

design Studio Original Designers65 Network

### Realizzata in resina e sabbia

Made of resin and sand

Réalisée en résine et sable

Hergestellt aus Harz und Sand

Realizada en resina y arena

Изготовлено из бамбука и песка



02

**Bianco lucido**  
Polished white



14

**Nero matt**  
Matt black



**1898**

L8,1 x P7,9 x H13,7 cm



**1811**

L15,2 x P11,5 x H2,9 cm



**1881**

L8,3 x P8,1 x H17,4 cm



**1833**

L11,8 x P11,5 x H46,2 cm

SERIE DA APPOGGIO. TABLE TOP SERIES.

GEDY

## Sofia.

### Realizzata in resina e sabbia

Made of resin and sand

Réalisée en résine et sable

Hergestellt aus Harz und Sand

Realizada en resina y arena

Изготовлено из бамбука и песка



02  
**Bianco lucido**  
Polished white



14  
**Nero matt**  
Matt black



**SF98**

L7,3 x P7,3 x H11,3 cm



**SF11**

L11 x P7 x H2,9 cm



**SF80**

L7,1 x P7,1 x H16,3 cm



**SF33**

L9,3 x P9,3 x H43,7 cm

SERIE DA APPOGGIO. TABLE TOP SERIES.

GEDY

## Libra.

Realizzata in resina e sabbia

Made of resin and sand

Réalisée en résine et sable

Hergestellt aus Harz und Sand

Realizada en resina y arena

Изготовлено из бамбука и песка



03  
Beige



**LB98**

L8,2 x P8,4 x H10,4 cm



**LB11**

L14,7 x P14 x H3,2 cm



**LB81**

L9,6 x P10,7 x H17,5 cm



**LB33**

L12,1 x P12,5 x H41,6 cm



SERIE DA APPOGGIO. TABLE TOP SERIES.

GEDY

## Aries.

**Realizzata in resina e sabbia**

Made of resin and sand

Réalisée en résine et sable

Hergestellt aus Harz und Sand

Realizada en resina y arena

Изготовлено из бамбука и песка



**AR98**

L9,2 x P6,5 x H11 cm



**AR11**

L12,2 x P8,6 x H2,4 cm



**AR80**

L9 x P6,4 x H16,8 cm



**AR33**

L10,5 x P10,5 x H40 cm





03  
Beige



08  
Grigio  
Grey



85  
Antracite  
Anthracite



SERIE DA APPOGGIO. TABLE TOP SERIES.

GEDY

Zoe.

NEW



20

Graniglia marmo  
bianco/nero  
Grit marble  
white/black

Realizzata in resina e pietra

Made of resin and stone

Réalisée en résine et pierre

Hergestellt aus Harz und Steiner

Realizada en resina y piedra

Изготовлено из смолы и камней



**Z098**

L7,4 x P7,4 x H11,3 cm



**Z011**

L11,5 x P7 x H 3 cm



**Z080**

L7 x P8,2 x H16,2 cm



**Z033**

L9,8 x P9,8 x H44 cm

SERIE DA APPOGGIO. TABLE TOP SERIES.

GEDY

# Irina.

design Simone Micheli

## Realizzata in resina

Made of resin

Réalisée en résine

Hergestellt aus Harz

Realizada en resina

Изготовлено из бамбука



02  
Bianco  
White



**IN98**

ø 10 x H11,5 cm



**IN11**

L12 x P12 x H2,5 cm



**IN80**

ø 9,5 x H15,5 cm



**IN33**

ø 11 x H46 cm

SERIE DA APPOGGIO. TABLE TOP SERIES.

GEDY

## Twist.

design Babled & Co.

### Realizzata in resina

Made of resin

Réalisée en résine

Hergestellt aus Harz

Realizada en resina

Изготовлено из бамбука



**4698**

L8,5 x P8,5 x H12 cm



**4611**

L13 x P9 x H3,5 cm



**4681**

L8,5 x P8,5 x H17,5 cm



**4633**

L12 x P13,5 x H47 cm



SERIE DA APPOGGIO. TABLE TOP SERIES.

GEDY

## Chanelle.

### Realizzata in resina

Made of resin

Réalisée en résine

Hergestellt aus Harz

Realizada en resina

Изготовлено из бамбука



**CH98**

L9 x P7 x H10,5 cm



**CH11**

L12 x P7,8 x H2,8 cm



**CH80**

L12 x P7 x H12,6 cm



**CH33**

L10,6 x P8,6 x H45,7 cm





02  
**Bianco**  
White



07  
**Verde menta**  
Green mint



10  
**Rosa**  
Pink



37  
**Pesca**  
Peach color



66  
**Tortora chiaro**  
Light  
turtledove grey



SERIE DA APPOGGIO. TABLE TOP SERIES.

GEDY

## Antares.

### Realizzata in resina

Made of resin

Réalisée en résine

Hergestellt aus Harz

Realizada en resina

Изготовлено из бамбука



**AT98**

L8 x P6,2 x H11,7 cm



**AT11**

L11,2 x P7,5 x H2,7 cm



**AT80**

L8 x P6,2 x H15,5 cm



**AT33**

L8,7 x P8 x H47 cm



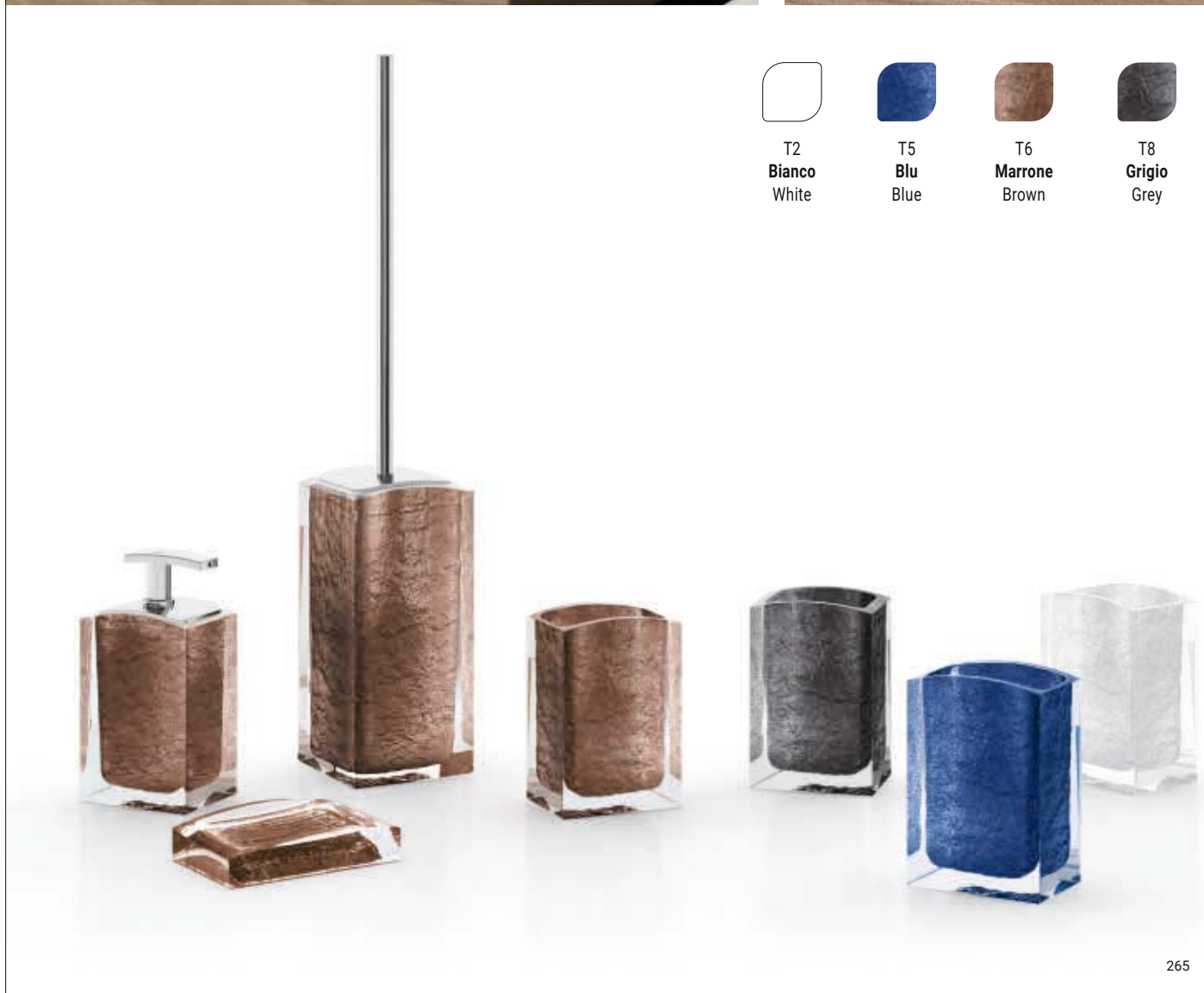

T2  
Bianco  
White



T5  
Blu  
Blue



T6  
Marrone  
Brown



T8  
Grigio  
Grey

SERIE DA APPOGGIO. TABLE TOP SERIES.

GEDY

## Rainbow.

Realizzata in resina

Made of resin

Réalisée en résine

Hergestellt aus Harz

Realizada en resina

Изготовлено из бамбука



02  
**Bianco**  
White



04  
**Verde acido**  
Acid green



05  
**Blu**  
Blue



06  
**Rosso**  
Red



07  
**Verde menta**  
Green mint



10  
**Rosa**  
Pink



14  
**Nero**  
Black



67  
**Arancione**  
Orange



73  
**Argento**  
Silver



79  
**Lilla**  
Lilac



52  
**Tortora**  
Turtledove grey



65  
**Blu petrolio**  
Petrol blue



66  
**Tortora chiaro**  
Light  
turtledove grey



86  
**Celeste**  
Sky blue



**RA98**  
L7,2 x P7,2 x H11 cm



**RA11**  
L11 x P7 x H3 cm



**RA81**  
L7 x P7 x H16,2 cm



**RA33**  
L9,8 x P9,8 x H37,5 cm



- 02
- 04
- 05
- 06
- 14
- 67
- 73
- 79



**RA80**  
L7 x P11,3 x H17,2 cm

- 02
- 04
- 05
- 06
- 14
- 67
- 73
- 79
- 52
- 66



**RA00**  
L19 x P11 x H7,5 cm

- 04
- 67



**RA08**  
L25 x P13,5 x H7,5 cm

SERIE DA APPOGGIO. TABLE TOP SERIES.

GEDY

## Giulia.

### Realizzata in resina

Made of resin

Réalisée en résine

Hergestellt aus Harz

Realizada en resina

Изготовлено из бамбука



T6  
Marrone  
Brown



**GU98**

L7 x P7 x H11 cm



**GU11**

L10,6 x P6,8 x H2 cm



**GU80**

L7 x P7 x H16 cm



**GU33**

L9,2 x P9,2 x H46 cm



SERIE DA APPOGGIO. TABLE TOP SERIES.

GEDY

## Idra.

### Realizzata in resina

Made of resin

Réalisée en résine

Hergestellt aus Harz

Realizada en resina

Изготовлено из бамбука



03  
Beige



**ID98**

ø 10,2 x H10,4 cm



**ID11**

L12,3 x P9 x H2,7 cm



**ID80**

ø 10,6 x H15,5 cm



**ID33**

ø 12,2 x H40 cm

SERIE DA APPOGGIO. TABLE TOP SERIES.

GEDY

## Gemini.

### Realizzata in resina

Made of resin

Réalisée en résine

Hergestellt aus Harz

Realizada en resina

Изготовлено из бамбука



**GM98**

ø 8,7 x H11,1 cm



**GM11**

L14 x P9,6 x H2,8 cm



**GM80**

L8,6 x P9,4 x H20,7 cm



**GM33**

ø 9,9 x H45,7 cm



02  
**Bianco**  
White



08  
**Grigio**  
Grey



52  
**Tortora**  
Turtledove grey



SERIE DA APPOGGIO. TABLE TOP SERIES.

GEDY

## Quadrotto.

### Realizzata in resina

Made of resin

Réalisée en résine

Hergestellt aus Harz

Realizada en resina

Изготовлено из бамбука



**QU98**

L10 x P6,5 x H11,2 cm



**QU11**

L11,2 x P11,2 x H2,4 cm



**QU81**

L8,2 x P8,2 x H16 cm



**QU33**

L9,5 x P9,5 x H46 cm





02  
Bianco  
White



08  
Grigio  
Grey



14  
Nero  
Black



66  
Tortora chiaro  
Light  
turtledove grey

SERIE DA APPOGGIO. TABLE TOP SERIES.

GEDY

## Sole.

### Realizzata in resina

Made of resin

Réalisée en résine

Hergestellt aus Harz

Realizada en resina

Изготовлено из бамбука



**SL98**

ø 7,2 x H12,2 cm



**SL11**

ø 11 x H2,9 cm



**SL80**

L7,2 x P7,5 x H15,7 cm



**SL33**

ø 9,8 x H40 cm



11  
**Azzurro**  
Light blue



63  
**Viola**  
Purple



67  
**Arancione**  
Orange

SERIE DA APPOGGIO. TABLE TOP SERIES.

GEDY

## Vega.



73  
Argento  
Silver

### Realizzata in resina

Made of resin

Réalisée en résine

Hergestellt aus Harz

Realizada en resina

Изготовлено из бамбука



**VG98**

ø 7 x H12 cm



**VG11**

ø 11 x H2,5 cm



**VG80**

ø 7 x H15,7 cm

SERIE DA APPOGGIO. TABLE TOP SERIES.

GEDY

**Kira.**

NEW



02

Bianco matt  
Matt white

**Realizzata in resina**

Made of resin

Réalisée en résine

Hergestellt aus Harz

Realizada en resina

Изготовлено из бамбука



**KI98**

ø 8,4 x H11,3 cm



**KI11**

ø 11,3 x H2,2 cm



**KI80**

L10,8 x P10,6 x H13,6 cm



**KI33**

ø 10,4 x H42 cm

SERIE DA APPOGGIO. TABLE TOP SERIES.

GEDY

Layla.

NEW



02  
Bianco  
White

Realizzata in resina

Made of resin

Réalisée en résine

Hergestellt aus Harz

Realizada en resina

Изготовлено из бамбука



**LL98**

L7,7 x P7,5 x H10,8 cm



**LL11**

L13,4 x P9,5 x H22 cm



**LL80**

L8,5 x P7,5 x H18,3 cm



**LL33**

L9,4 x P9,4 x H41,5 cm

SERIE DA APPOGGIO. TABLE TOP SERIES.

GEDY

## Yvonne.

### Realizzata in resina

Made of resin

Réalisée en résine

Hergestellt aus Harz

Realizada en resina

Изготовлено из бамбука



08  
Grigio  
Grey



**YV98**

L9,3 x P9,6 x H9 cm



**YV11**

L11,7 x P11,8 x H2,3 cm



**YV80**

L10,8 x P12 x H14,4 cm



**YV33**

L15 x P12,5 x H38 cm



**YV34**

L15 x P12,5 x H43,5 cm

SERIE DA APPOGGIO. TABLE TOP SERIES.

GEDY

**Helen.**

**NEW**

**Realizzata in resina**

Made of resin

Réalisée en résine

Hergestellt aus Harz

Realizada en resina

Изготовлено из бамбука



**HE98**

ø 7,2 x H10 cm



**HE11**

L13 x P9 x H2,5 cm



**HE80**

L8,5 x ø 7,5 x H17 cm



**HE33**

ø 9,5 x H42,5 cm





02  
**Bianco**  
White



08  
**Grigio**  
Grey



14  
**Nero**  
Black



SERIE DA APPOGGIO. TABLE TOP SERIES.

GEDY

## Petra.

### Realizzata in resina

Made of resin

Réalisée en résine

Hergestellt aus Harz

Realizada en resina

Изготовлено из бамбука



08  
Grigio  
Grey



**PT98**

ø 7,5 x H11 cm



**PT11**

L13,7 x P10 x H2,4 cm



**PT80**

ø 7,5 x H15,8 cm



**PT33**

ø 9 x H44,5 cm

SERIE DA APPOGGIO. TABLE TOP SERIES.

GEDY

**Brenda.**

NEW



14  
Nero matt  
Matt black

**Realizzata in resina**

Made of resin

Réalisée en résine

Hergestellt aus Harz

Realizada en resina

Изготовлено из бамбука



**BR98**

ø 7 x H10 cm



**BR11**

L13,7 x P9,8 x H2,8 cm



**BR80**

L9,2 x P7 x H16,3 cm



**BR06**

L21,5 x P15,2 x H2,5 cm



**BR03**

ø 10 x H9,5 cm



**BR33**

ø 9,5 x H36,2 cm

SERIE DA APPOGGIO. TABLE TOP SERIES.

GEDY

## Dori.

### Realizzata in resina

Made of resin

Réalisée en résine

Hergestellt aus Harz

Realizada en resina

Изготовлено из бамбука



92  
Turchese  
Turquoise



**DR98**

ø 8,5 x H10,6 cm



**DR11**

L17,5 x P11,7 x H1,7 cm



**DR80**

L13,6 x P10,2 x H16,4 cm



**DR33**

ø 11,3 x P9,5 x H37,8 cm

SERIE DA APPOGGIO. TABLE TOP SERIES.

GEDY

## Pyxis.

Realizzata in resine termoplastiche

Made of thermoplastic resins

Réalisée en résine thermoplastique

Hergestellt aus Kunststoff

Realizada en resinas termoplásticas

Изготовлено из термопластиченых смол



89

Bianco/blu  
White/blue

SERIE DA APPOGGIO  
Table top series



**PY10**

ø 7,2 x H12 cm



**PY11**

L11 x P7,6 x H3,3 cm



**PY80**

ø 7 x H18,5 cm



**PY33**

ø 10,2 x H35 cm

SERIE DA APPOGGIO. TABLE TOP SERIES.

GEDY

100% MADE  
in Italy



# Seventy.

design Matteo Thun

Realizzata in resine termoplastiche

Made of thermoplastic resins

Réalisée en résine thermoplastique

Hergestellt aus Kunststoff

Realizada en resinas termoplásticas

Изготовлено из термопластиченых смол



08  
Grigio  
Grey



22  
Bianco  
White



27  
Acquamarina  
Aquamarine



52  
Tortora  
Turtledove grey



65  
Blu petrolio  
Petrol blue



66  
Beige  
Beige



79  
Lilla  
Lilac



86  
Celeste  
Sky blue



V7  
Verde pistacchio  
Pistachio green



design  
R & S Gedy



6398

L6,5 x P6,5 x H12,2 cm



6311

L13,8 x P9 x H2,5 cm



6382

L6,5 x P7,1 x H16 cm



6334

L9 x P9 x H38,8 cm



6309

pag. 338



- 08
- 22
- 27
- 52
- 65
- 66
- 86

design  
R & S Gedy

22

22



**6308**

L11,6 x P11,6 x H12,4 cm  
1,2 LT



**6300**

L11,6 x P11,6 x H12,1 cm



**6305**

L5,5 x P5,5 x H11 cm



**6306**

L27 x P13,6 x H2,2 cm



**6302**

L20 x P12 x H6,4 cm



SERIE DA APPOGGIO. TABLE TOP SERIES.

GEDY

## Seventy.

22

66

100% MADE  
in Italy

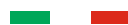

design Makio Hasuike

### Organizer con specchio

Organizer with mirror  
Organiseur avec miroir  
Organizer mit Spiegel  
Organizador con espejo  
Органайзер с зеркалом



### Realizzato in resine termoplastiche e vetro

Made of thermoplastic resins and glass  
Réalisée en résine thermoplastique et verre  
Hergestellt aus Kunststoff und Glas  
Realizada en resinas termoplásticas y cristal

Изготовлено из термопластиченых смол и стекло

6301

L25 x P28 x H7,1 cm

## Seventy.

### Dispenser per dentifricio

Distributeur de dentifrice  
Zahnpastaspender  
Dispensador de pasta de dientes  
Диспенсер для зубной пасты

22



MADE  
in Italy



NEW

design  
R & S Gedy

### Realizzato in resine termoplastiche

Made of thermoplastic resins  
Réalisée en résine thermoplastique  
Hergestellt aus Kunststoff  
Realizada en resinas termoplásticas  
Изготовлено из термопластиченых смол

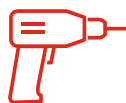

Con viti

With screws



Con biadesivo

With double sided

tape



6385

L7 x P7,1 x H13 cm



Guarda il video x scoprire di più sul prodotto

Watch the video to find out more about the product



SERIE DA APPOGGIO. TABLE TOP SERIES.

GEDY

**Seventy.**

design Matteo Thun

NEW

100% MADE  
in Italy



Save the  
planet

EKoplā



Riciclabile  
Recyclable



Riciclato  
Recycled



14  
Nero matt  
Matt black

**Materiale plastico riciclato**

Recycled plastic

Plastique recyclé

Recyceltes Kunststoffmaterial

Material plástico reciclado

Переработанный пластик



**6398**

L6,5 x P6,5 x H12,2 cm



**6312**

L12,4 x P8 x H2,1 cm



**6382**

L6,5 x P7,1 x H16 cm



**6333**

L9 x P9 x H38,8 cm

design  
R & S Gedy

SERIE DA APPOGGIO. TABLE TOP SERIES.

GEDY

100% MADE  
in Italy



# Glady.

**Realizzata in resine termoplastiche**

Made of thermoplastic resins

Réalisée en résine thermoplastique

Hergestellt aus Kunststoff

Realizada en resinas termoplásticas

Изготовлено из термопластиченых смол



00  
**Trasparente**  
Transparent



02  
**Bianco**  
White



04  
**Verde acido**  
Acid green



05  
**Blu**  
Blue



29  
**Moka**  
Moka



76  
**Fucsia**  
Fuchsia



79  
**Lilla**  
Lilac



85  
**Antracite**  
Anthracite



92  
**Turchese**  
Turquoise



**GL98**

ø 8,5 x H11 cm



**GL11**

L12,3 x P8 x H2,5 cm



**GL80**

ø 8,5 x H17 cm



**GL33**

ø 13,2 x H40,5 cm



**GL00**

L18,8 x P10,7 x H7,5 cm



**GL09**

pag. 337



SERIE DA APPOGGIO. TABLE TOP SERIES.

GEDY

100% MADE  
in Italy



Sharon.

NEW

Realizzata in resine termoplastiche

Made of thermoplastic resins

Réalisée en résine thermoplastique

Hergestellt aus Kunststoff

Realizada en resinas termoplásticas

Изготовлено из термопластиченых смол



02  
Bianco  
White



08  
Grigio  
Grey



14  
Nero matt  
Matt black



**SH98**  
ø 7 x H11,8 cm



**SH11**  
L12,3 x P8,2 x H2,1 cm



**SH80**  
ø 7 x H16,5 cm



**SH33**  
ø 9 x H38,4 cm



SERIE DA APPOGGIO. TABLE TOP SERIES.

GEDY

100% MADE  
in Italy



02  
Bianco  
White

## Moby.

### Realizzata in resine termoplastiche

Made of thermoplastic resins

Réalisée en résine thermoplastique

Hergestellt aus Kunststoff

Realizada en resinas termoplásticas

Изготовлено из термопластиченых смол



**3198**

L8,7 x P8,3 x H11,5 cm



**3111**

L15 x P12 x H5,5 cm



**3182**

L8,7 x P8,3 x H16,5 cm



**3133**

L11 x P10,9 x H37,8 cm

GEDY

## Spot.

### Portasapone in PVC

Soap holder made of PVC

Porte savon en PVC

Seifenschale aus PVC

Jabonera en PVC

Мыльница из ПВХ

#### Colori trasparenti - Transparent colours



P1  
Azzurro  
Light blue



P2  
Trasparente  
Transparent



P8  
Verde acido  
Acid green

#### Colori pieni - Solid colours



02  
Bianco  
White



08  
Grigio  
Grey



66  
Tortora chiaro  
Light  
turtledove grey

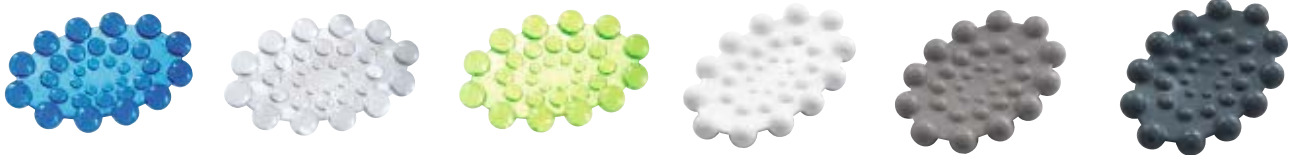

2004

L12,7 x P8,7 x H1,6 cm

GEDY

## Silverino.

NEW

### Disco antibatterico - resine termoplastiche e argento

Antibacterial disc - silver and thermoplastic resins

Disque antibactérien - argent et résine thermoplastique

Antibakterielle Scheibe - Silber und Kunststoff

Disco antibacteriano - plata y resinas termoplásticas

Антибактериальный диск

серебро и термопластиченых смол



con Antibatterico  
with Antibacterial



2020

ø 4 x H0,4 cm



Guarda il video x  
scoprire di più sul  
prodotto

Watch the video to find  
out more about the  
product

100% MADE  
in Italy



00





**SPECCHI E  
ILLUMINAZIONE**  
Mirrors and lighting







# Specchi con luci

Mirrors with lights - Miroirs avec éclairage - Spiegel mit Beleuchtung  
Espejos con luces - Зеркала со светильником

**Paul.**

TOP DESIGN

**Specchio con luci a led  
e sistema anti-appannamento**

Mirror with LED lights and anti-fog system

Miroir avec lumières LED et système anti-buée

Spiegel mit LED-Leuchten und Beschlagschutzsystem

Espejo con luces led y sistema antiempañamiento

Зеркало со светодиодной подсветкой

и системой антизапотевания



**Anti  
appannamento**

Anti fog



**Reversibile  
Reversible**



**Digital  
touch**



**Garanzia LED  
LED Warranty**



**ECO  
Friendly**



**Senza piombo  
Lead Free**



**Luce ad alta  
precisione  
High precision  
light**

**MADE  
in  
Spain**

CE  
IP 44 - RoHS  
220-240 V  
50-60 Hz  
anti fog 22W  
CLASS EXEMPT  
GROUP EN 62471  
CRI>91



**Cornice in alluminio** - Frame in aluminium - Cadre en aluminium - Aluminiumrahmen - Marco de aluminio - Алюминиевая рама

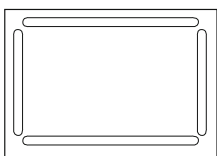

**3204**

L140 x P2,6 x H80 cm  
42W - 1140 lumen - 5700°K

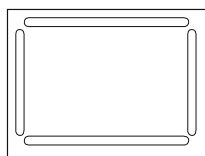

**3203**

L120 x P2,6 x H80 cm  
40W - 900 lumen - 5700°K

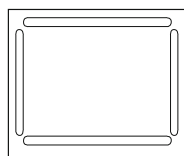

**3202**

L100 x P2,6 x H80 cm  
40W - 850 lumen - 5700°K

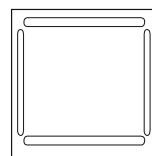

**3201**

L80 x P2,6 x H80 cm  
30W - 880 lumen - 5700°K

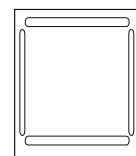

**3200**

L60 x P2,6 x H80 cm  
30W - 740 lumen - 5700°K



**38  
Spazzolato  
Brushed**

# Paul.

TOP DESIGN

## Specchio con luci a led

Mirror with LED lights

Miroir avec lumières LED

Spiegel mit LED-Leuchten

Espejo con luces led

Зеркало со светодиодной подсветкой



Reversibile  
Reversible



Digital  
touch



Garanzia LED  
LED Warranty



ECO  
Friendly



Senza piombo  
Lead Free



Luce ad alta  
precisione  
High precision  
light

MADE  
in  
Spain

CE  
IP 44 - RoHS  
220-240 V  
50-60 Hz



Cornice in alluminio - Frame in aluminium - Cadre en aluminium - Aluminiumrahmen - Marco de aluminio - Аллюминиевая рама

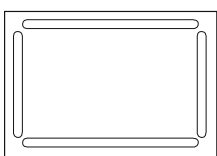

3004

L140 x P2,6 x H80 cm  
42W - 1140 lumen - 5700°K

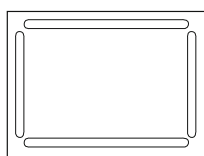

3003

L120 x P2,6 x H80 cm  
40W - 900 lumen - 5700°K

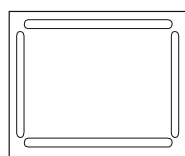

3002

L100 x P2,6 x H80 cm  
40W - 850 lumen - 5700°K

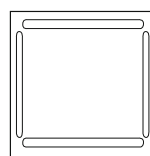

3001

L80 x P2,6 x H80 cm  
30W - 880 lumen - 5700°K

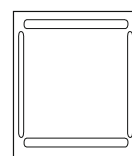

3000

L60 x P2,6 x H80 cm  
30W - 740 lumen - 5700°K



14  
Nero matt  
Matt black



38  
Spazzolato  
Brushed

# Salvador.

TOP DESIGN

## Specchio filo lucido con luci a led e sistema anti-appannamento

Polished wire mirror with LED lights and anti-fog system

Miroir bord brillant avec lumières LED et système anti-buée

Spiegel mit polierten Kanten mit LED-Leuchten

und Beschlagschutzsystem

Espejo canto pulido  $\varnothing$  90 con luces led y sistema antiempañamiento

Зеркало с полированной кромкой, светодиодной подсветкой

и системой антизапотевания



Anti  
appannamento

Anti fog



Garanzia LED  
LED Warranty



ECO  
Friendly



Senza piombo  
Lead Free

MADE  
in  
Spain



IP 44 - RoHS  
220-240 V  
50-60 Hz  
anti fog 22W  
CLASS EXEMPT  
GROUP EN 62471

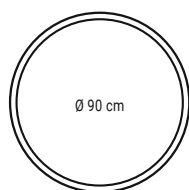

$\varnothing$  90 cm

**3055**

$\varnothing$  90 x P2,6 cm

30W - 1770 lumen - 5700°K - CRI>90

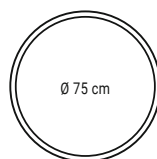

$\varnothing$  75 cm

**3054**

$\varnothing$  75 x P2,6 cm

20W - 1140 lumen - 5700°K - CRI>83

Specchi con luci - Mirrors with lights.

# Leonard.

TOP DESIGN

## Specchio con luci a led

Mirror with LED lights

Miroir avec lumières LED

Spiegel mit LED-Leuchten

Espejo con luces led

Зеркало со светодиодной подсветкой



Garanzia LED  
LED Warranty



ECO  
Friendly

MADE  
in  
Spain



Senza piombo  
Lead Free



Luce ad alta  
precisione  
High precision  
light

CE  
IP 44 - RoHS  
220 - 240 V  
50-60 Hz  
CLASS EXEMPT  
GROUP EN 62471  
CRI>90



Cornice in alluminio - Frame in aluminium - Cadre en aluminium - Aluminiumrahmen - Marco de aluminio - Алюминиевая рама



**3053**

L120 x P3 x H70 cm  
14W - 1657 lumen - 4000°K

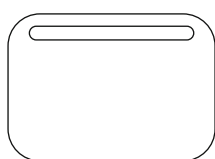

**3052**

L100 x P3 x H70 cm  
12W - 1280 lumen - 4000°K

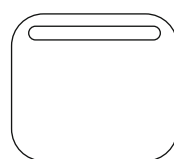

**3051**

L80 x P3 x H70 cm  
10W - 1200 lumen - 4000°K

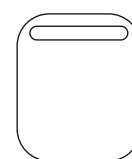

**3050**

L60 x P3 x H70 cm  
7W - 846 lumen - 4000°K



14  
Nero matt  
Matt black

# Amedeo.

TOP DESIGN

## Specchio filo lucido ovale con luci a led

Oval polished edge mirror with LED lights

Miroir bord poli ovale avec lumières LED

Ovaler Spiegel mit polierten Kanten und LED-Leuchten

Espejo canto pulido ovalado con luces led

Овальное зеркало с полированной кромкой

и светодиодной подсветкой



Reversibile  
Reversible



Garanzia LED  
LED Warranty

MADE  
in  
Spain



ECO  
Friendly



Senza piombo  
Lead Free

CE  
IP 44 - RoHS  
220-240 V  
50-60 Hz  
5700°K CLASS  
EXEMPT GROUP  
EN 62471

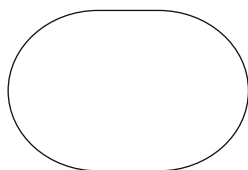

**3056**

L85 x P3 x H60 cm

30W - 898 lumen - 5700°K - CRI>90



**3057**

L90 x P3 x H45 cm

20W - 880 lumen - 5700°K - CRI>85

Specchi con luci - Mirrors with lights.

# Alfred.

TOP DESIGN

## Specchio filo lucido con luci a led

Polished edge mirror with LED lights

Miroir bord poli avec lumières LED

Spiegel mit polierten Kanten und LED-Leuchten

Espejo canto pulido con luces led

Зеркало с полированной кромкой и  
светодиодной подсветкой



Reversibile  
Reversible



Digital  
touch

100% MADE  
in Italy



Garanzia LED  
LED Warranty

CE  
IP 44 - RoHS  
220 - 240 V  
50-60 Hz  
EXEMPT GROUP  
EN 62471



**3157**

L140 x P2,6 x H70 cm

36W - 1100 lumen - 4000°K - CRI>91

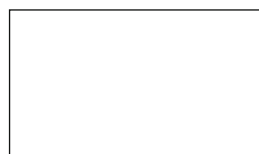

**3156**

L120 x P2,6 x H70 cm

32W - 960 lumen - 4000°K - CRI>91



**3155**

L100 x P2,6 x H70 cm

29W - 870 lumen - 4000°K - CRI>90



**3154**

L80 x P2,6 x H60 cm

24W - 720 lumen - 4000°K - CRI>91

# Pierre.

TOP DESIGN

## Specchio filo lucido con luci a led e bordo sabbiato

Polished edge mirror with LED lights and sandblasted border

Miroir bord poli avec lumières LED et bord sablé

Spiegel mit polierten Kanten und LED-Leuchten und sandgestrahltem Rand

Espejo canto pulido con luces led y marco arenado

Зеркало с полированной кромкой, светодиодной подсветкой и окантовкой, подвергнутой пескоструйной обработке



Reversibile  
Reversible



Digital  
touch

100% MADE  
in **Italy**



Garanzia LED  
LED Warranty

CE  
IP 44 - RoHS  
220-240 V  
50-60 Hz  
EXEMPT GROUP  
EN 62471



**3253**

L140 x P2,6 x H70 cm

34W - 1940 lumen - 4000°K - CRI>91



**3252**

L120 x P2,6 x H70 cm

31W - 1770 lumen - 4000°K - CRI>91



**3251**

L100 x P2,6 x H70 cm

27W - 1540 lumen - 4000°K - CRI>90



**3250**

L80 x P2,6 x H60 cm

22W - 1250 lumen - 4000°K - CRI>91



Specchi con luci - Mirrors with lights.

**Edgar.**

TOP DESIGN

**Specchio filo lucido con luci a led**

Polished edge mirror with LED lights

Miroir bord poli avec lumières LED

Spiegel mit polierten Kanten und LED-Leuchten

Espejo canto pulido con luces led

Зеркало с полированной кромкой и

светодиодной подсветкой



Digital  
touch



Garanzia LED  
LED Warranty

100% MADE  
in Italy



CE  
IP 44 - RoHS  
220 - 240 V  
50-60 Hz  
EXEMPT GROUP  
EN 62471

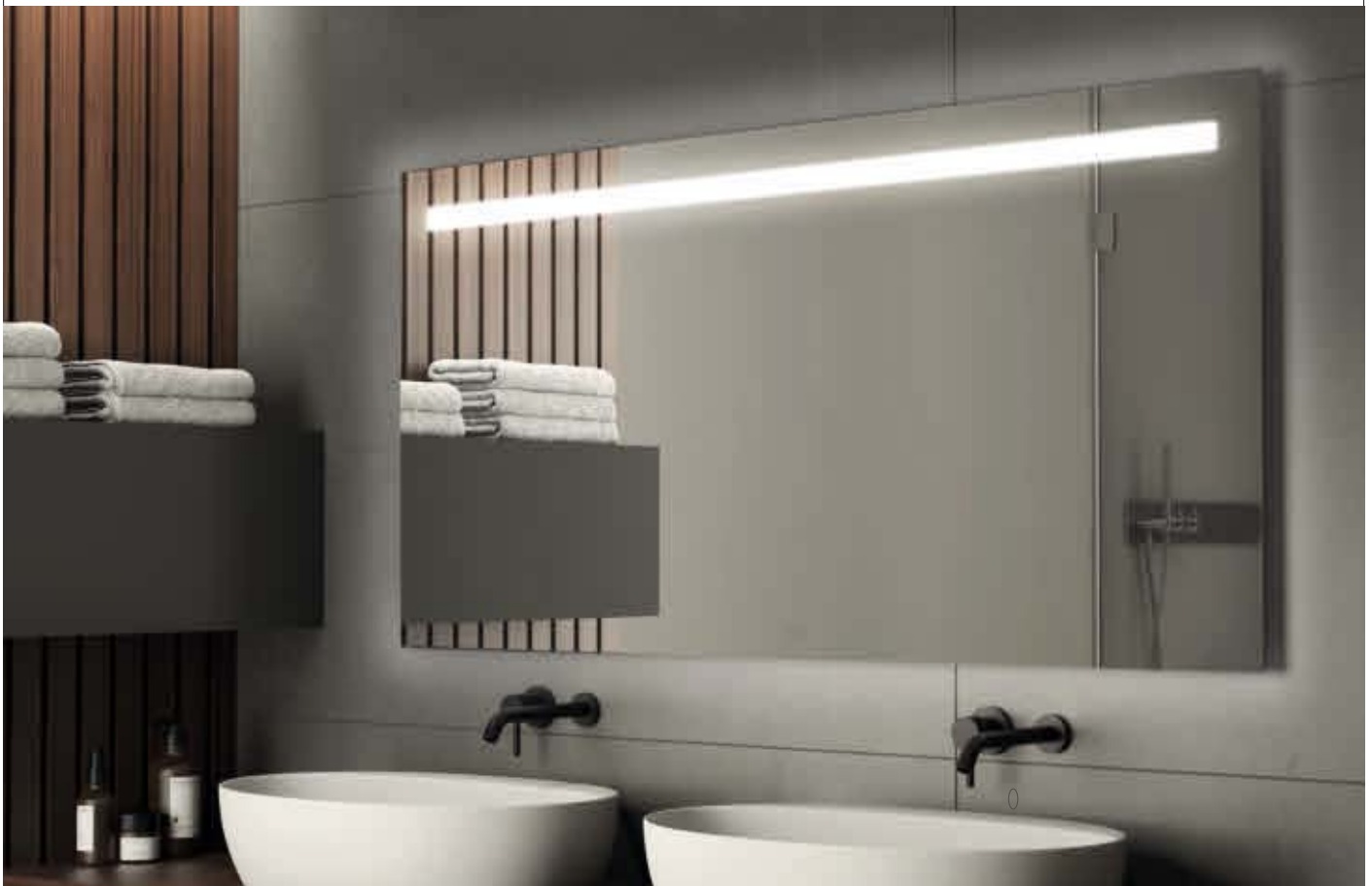

**3256**

L140 x P2,6 x H70 cm

48W - 4770 lumen - 4000°K - CRI>91



**3255**

L120 x P2,6 x H70 cm

42W - 4230 lumen - 4000°K - CRI>91



**3254**

L100 x P2,6 x H70 cm

37W - 3690 lumen - 4000°K - CRI>90

SPECCHIE  
ILLUMINAZIONE  
Mirrors and lighting

**Jeff.**

TOP DESIGN

**Specchio con luci a led e bordo sabbiato**

Mirror with LED lights and sandblasted border

Miroir avec lumières LED et bord sablé

Spiegel mit LED-Leuchten und sandgestrahltem Rand

Espejo con luces led y marco arenado

Зеркало со светодиодной подсветкой и окантовкой, подвергнутой пескоструйной обработке



Reversibile  
Reversible



Digital  
touch

100% MADE  
in **Italy**



Garanzia LED  
LED Warranty



Luce ad alta  
precisione  
High precision  
light

CE  
IP 44 - RoHS  
220-240 V  
50-60 Hz  
EXEMPT GROUP  
EN 62471



**Cornice in PVC** - Frame of PVC - Cadre en PVC - PVC-Rahmen - Marco de PVC - Рама из ПВХ

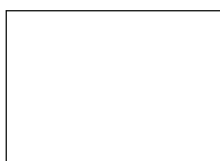

**3304**

L110 x P2,6 x H80 cm

20W - 1980 lumen - 4000°K - CRI>91



**3303**

L100 x P2,6 x H70 cm

18W - 1800 lumen - 4000°K - CRI>91



**3302**

L80 x P2,6 x H60 cm

11W - 1080 lumen - 4000°K - CRI>90



14  
**Nero matt**  
Matt black

Specchi con luci - Mirrors with lights.

**George.**

TOP DESIGN

**Specchio filo lucido con luci a led**

Polished edge mirror with LED lights

Miroir bord poli avec lumières LED

Spiegel mit polierten Kanten und LED-Leuchten

Espejo canto pulido con luces led

Зеркало с полированной кромкой и

светодиодной подсветкой



Digital  
touch



Garanzia LED  
LED Warranty

100% MADE  
in Italy



CE  
IP 44 - RoHS  
220 - 240 V  
50-60 Hz  
EXEMPT GROUP  
EN 62471

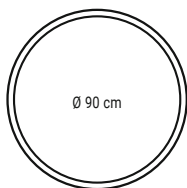

Ø 90 cm

**3307**

Ø 90 x P3 cm

24W - 720 lumen - 4000°K - CRI>91

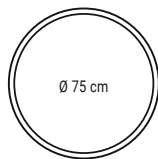

Ø 75 cm

**3306**

Ø 75 x P3 cm

20W - 600 lumen - 4000°K - CRI>91

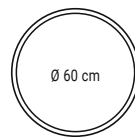

Ø 60 cm

**3305**

Ø 60 x P3 cm

16W - 480 lumen - 4000°K - CRI>90

SPECCHIE  
ILLUMINAZIONE  
Mirrors and lighting

## Franz.

TOP DESIGN

### Specchio ovale con luci a led e bordo sabbato

Oval mirror with LED lights and sandblasted border

Miroir ovale avec lumières LED et bord sablé

Ovaler Spiegel mit LED-Leuchten und sandgestrahltem Rand

Espejo ovalado con luces led y marco arenado

Овальное зеркало со светодиодной подсветкой и окантовкой, подвергнутой пескоструйной обработке



Reversibile  
Reversible



Digital  
touch



Garanzia LED  
LED Warranty



Luce ad alta  
precisione

High precision  
light

100% MADE  
in Italy



IP 44 - RoHS  
220-240 V  
50-60 Hz  
EXEMPT GROUP  
EN 62471  
CRI>90



Cornice in metallo - Frame in metal - Cadre en métal - Metall-Rahmen - Marco de metal - Металл рама

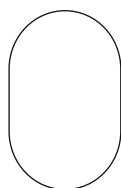

3058

L50 x P4 x H90 cm  
20W - 1980 lumen - 4000°K



14  
Nero matt  
Matt black

Specchi con luci - Mirrors with lights.

**Marc.**

TOP DESIGN

**Specchio con luci a led e bordo sabbiato**

Mirror with LED lights and sandblasted border

Miroir avec lumières LED et bord sablé

Spiegel mit LED-Leuchten und sandgestrahltem Rand

Espejo con luces led y marco arenado

Зеркало со светодиодной подсветкой и окантовкой, подвергнутой пескоструйной обработке



Digital touch

100% MADE in Italy



Garanzia LED  
LED Warranty



Luce ad alta  
precisione

High precision  
light

CE  
IP 44 - RoHS  
220 - 240 V  
50-60 Hz  
EXEMPT GROUP  
EN 62471



**Cornice in metallo** - Frame in metal - Cadre en métal - Metall-Rahmen - Marco de metal - Metall рама

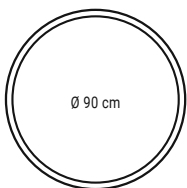

Ø 90 cm

**3258**

Ø 90 x P4 cm

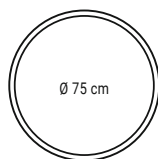

Ø 75 cm

**3257**

Ø 75 x P4 cm

23W - 2340 lumen - 4000°K - CRI>91    19W - 1935 lumen - 4000°K - CRI>90



14  
**Nero matt**  
Matt black

SPECCHIE  
ILLUMINAZIONE  
Mirrors and lighting

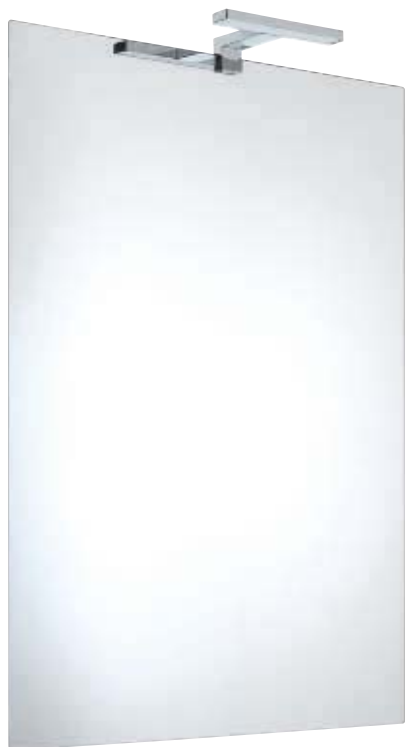

## 2556-01 William.

GEDY

### Specchio filo lucido con luce led

Polished edge mirror with led light

Miroir bord poli avec lumière led

Spiegel mit polierten Kanten mit LED-Leuchten

Espejo canto pulido con luce led

Зеркало с полированными краями со

светодиодной подсветкой

L60 x P13,5 x H84,6 cm

NEW

MADE  
in **Italy**



Reversible  
Reversible

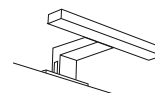

CE

IP 44 - 230V-50Hz  
LED 3,62W - 6000K\*  
220 lumen - CRI 90



## 8001 Junior.

design Gianpietro Tonetti

GEDY

### Specchio

Mirror - Miroir - Spiegel - Espejo - Зеркало

### Cornice in resina termoplastica

Frame of thermoplastic resins

Cadre en résine thermoplastique

Kunststoff-Rahmen

Marco de resinas termoplásticas

Рама из термопластичных смол



02  
Bianco  
White

CE

L55 x P5,5 x H60 cm

IP 20 - W25 - E14  
NORMA EN 605998 - 1/2 - 1 & 2006/95/CE

# Specchi senza luci

Mirrors without lights - Miroirs sans éclairage  
Spiegel ohne Beleuchtung - Espejos sin luces - Зеркала без подсветки

## Henri.

TOP DESIGN

Specchio

Mirror - Miroir

Spiegel - Espejo

Зеркало



Reversibile  
Reversible

100% MADE  
in Italy



Cornice in PVC - Frame of PVC - Cadre en PVC - PVC-Rahmen - Marco de PVC - Рама из ПВХ



**3153**

L100 x P2,6 x H70 cm



**3152**

L90 x P2,6 x H65 cm



**3151**

L80 x P2,6 x H60 cm



**3150**

L70 x P2,6 x H50 cm



38  
Spazzolato  
Brushed



## 2590 Jackson.

100% MADE  
in Italy



GEDY

### Specchio infrangibile

Mirror with shatterproof surface

Mirror infrangible

Bruchsicherer Spiegel

Espejo irrompible

Зеркало с полированными



Reversible  
Reversible

L60 x P2,5 x H70 cm

Acciaio inox - stainless steel - acier inox  
Edelstahl - нержавеющей сталь



13  
Super  
Mirror

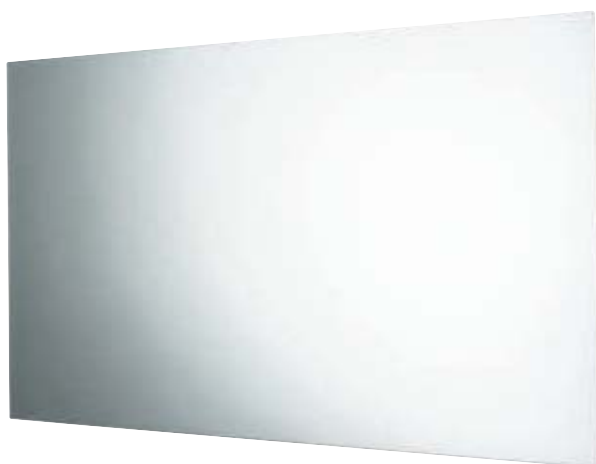

## 2557 William.

100% MADE  
in Italy



GEDY

### Specchio filo lucido

Polished edge mirror

Miroir bord poli

Spiegel mit polierten Kante

Espejo canto pulido

Зеркало с полированными краями



Reversible  
Reversible

L100 x P2 x H70 cm



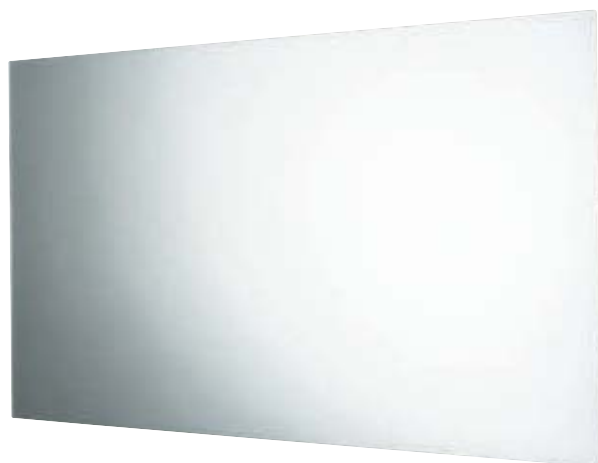

## 2551 William.

100% MADE  
in **Italy**



GEDY

### Specchio filo lucido

Polished edge mirror

Mirror bord poli

Spiegel mit polierten Kante

Espejo canto pulido

Зеркало с полированными краями



Reversible

Reversible

L100 x P2 x H60 cm



## 2556 William.

100% MADE  
in **Italy**



GEDY

### Specchio filo lucido

Polished edge mirror

Miroir bord poli

Spiegel mit polierten Kante

Espejo canto pulido

Зеркало с полированными краями



Reversible

Reversible

L60 x P2 x H80 cm



## 2540. 2550 William.

100% MADE  
in Italy



GEDY

### Specchio filo lucido

Polished edge mirror

Mirror bord poli

Spiegel mit polierten Kante

Espejo canto pulido

Изготовлено из овлонолено



Reversibile

Reversible

**2540**

L50 x P2 x H80 cm

**2550**

L60 x P2 x H70 cm



## 2545. 2560 William.

100% MADE  
in Italy



GEDY

### Specchio bisellato

Bevelled mirror

Miroir biseauté

Spiegel mit Facettenschliff

Espejo biselado

Зеркало со скшенными краями



Reversibile

Reversible

**2545**

L50 x P2 x H80 cm

**2560**

L60 x P2 x H70 cm



## 8400 Dakota.

design Carlo Vietri

GEDY

### Specchio filo lucido

Polished edge mirror

Mirror bord poli

Spiegel mit polierten Kante

Espejo canto pulido

Изготовлено из овленолено

L50 x P2 x H65 cm

100% MADE  
in Italy



Reversible  
Reversible

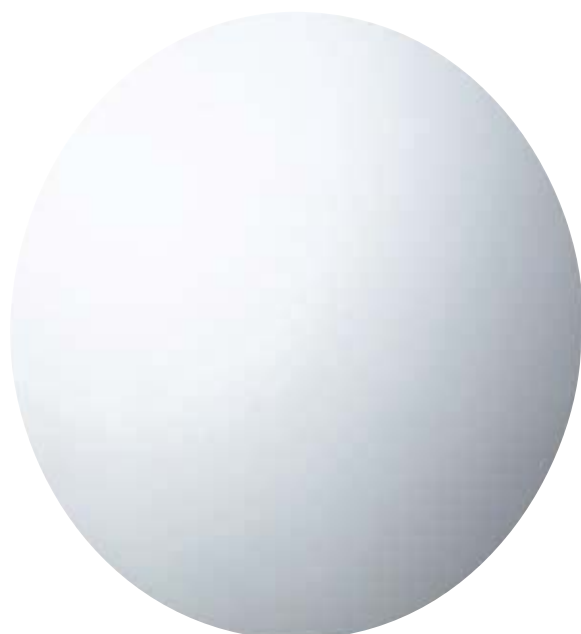

## 2554 William.

100% MADE  
in Italy



GEDY

### Specchio filo lucido

Polished edge mirror

Miroir bord poli

Spiegel mit polierten Kante

Espejo canto pulido

Зеркало с полированными краями

ø 80 x P2 cm

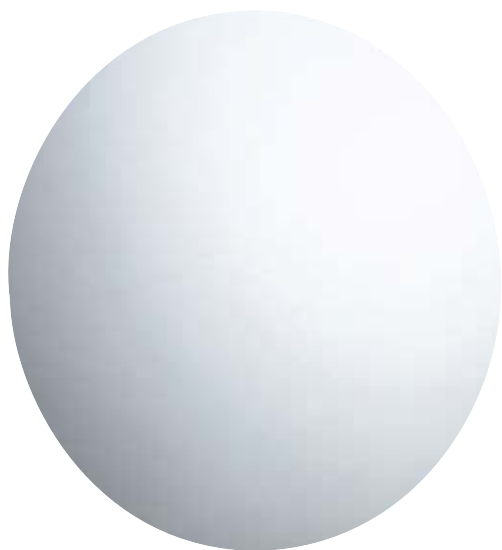

## 2520 William.

100% MADE  
in Italy



GEDY

### Specchio filo lucido

Polished edge mirror

Mirror bord poli

Spiegel mit polierten Kante

Espejo canto pulido

Изготовлено из овленолено

∅ 65 x P2 cm

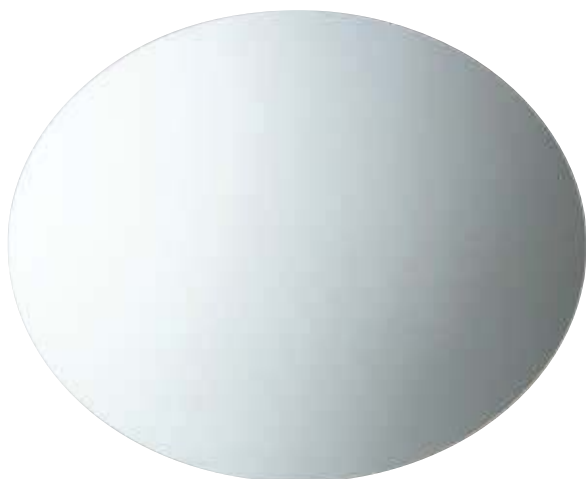

## 2575 William.

100% MADE  
in Italy



GEDY

### Specchio filo lucido ovale

Polished edge ovale mirror

Miroir ovale bord poli

Ovaleer Spiegel mit polierten Kante

Espejo ovaleado canto pulido

Зеркало овальное

с полированными краями

L75 x P2 x H55 cm



Reversible  
Reversible



## 2604.

100% MADE  
in Italy



GEDY

### Specchio

Mirror - Miroir - Spiegel - Espejo - Зеркало

### Cornice in resina termoplastica

Frame of thermoplastic resins

Cadre en résine thermoplastique

Kunststoff-Rahmen

Marco de resinas termoplásticas

Рама из термопластичных смол

L60 x P6 x H70 cm



02  
Bianco  
White

Specchi senza luci - Mirrors without lights.

**6000.**

GEDY

100% MADE  
in Italy



**Specchio**

Mirror

Miroir

Spiegel

Espejo

Зеркало



**Cornice in resine termoplastiche** - Frame of thermoplastic resins - Cadre en résine thermoplastique - Kunststoff-Rahmen  
Marco de resinas termoplásticas - Рама из термопластиченых смол

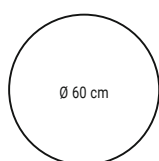

Ø 60 cm

**6000**

Ø 60 x P3 cm



02

**Bianco**  
White



14

**Nero**  
Black

## 6004.

GEDY

L55 x P3 x H55 cm



### Specchio

Mirror - Miroir - Spiegel - Espejo - Зеркало

### Cornice in resina termoplastica

Frame of thermoplastic resins

Cadre en résine thermoplastique

Kunststoff-Rahmen

Marco de resinas termoplàsticas

Рама из термопластичных смол

100% MADE  
in Italy



02

Bianco  
White

## 2901.

GEDY

L45 x P14,7 x H60 cm



### Specchio con mensola

Mirror with shelf - Miroir avec étagère

Spiegel mit Ablage - Espejo con estante

Зеркало со полочка

### Cornice in resina termoplastica

Frame of thermoplastic resins

Cadre en résine thermoplastique

Kunststoff-Rahmen

Marco de resinas termoplàsticas

Рама из термопластичных смол

100% MADE  
in Italy



02

Bianco  
White

## 2900.

GEDY

L45 x P4 x H45 cm



### Specchio

Mirror - Miroir - Spiegel - Espejo - Зеркало

### Cornice in resina termoplastica

Frame of thermoplastic resins

Cadre en résine thermoplastique

Kunststoff-Rahmen

Marco de resinas termoplàsticas

Рама из термопластичных смол

100% MADE  
in Italy



02

Bianco  
White

## 8000 Junior.

GEDY

L55 x P3,5 x H60 cm



design Gianpietro Tonetti

100% MADE  
in Italy



### Specchio

Mirror - Miroir - Spiegel - Espejo - Зеркало

### Cornice in resina termoplastica

Frame of thermoplastic resins

Cadre en résine thermoplastique

Kunststoff-Rahmen

Marco de resinas termoplàsticas

Рама из термопластичных смол



02

Bianco  
White

# Specchi contenitori e armadietti

Mirror cabinets and cabinets - Meubles à miroirs et armoires  
Behälterspiegel und kleine Schränken - Espejos contenedores y armarios  
Шкаф изготовлено из нержавеющей

## 2806-01 Banjo.

NEW

GEDY

L51 x P23 x H64,6 cm



13

Lucido/cromato  
Polished/chromed

MADE  
in Italy

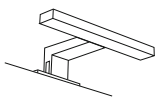

CE  
IP 44 - 230V-50Hz  
LED 3,62W - 6000K\*  
220 lumen - CRI 90



Con anta a specchio reversibile e 1 ripiano e con luce led

With reversible mirror door and 1 shelf and with led light

Avec porte à miroir réversible et 1 étagère et avec lumière led

Mit reversibler Spiegeltür und 1 Ablage und mit LED-Leuchten

Con puerta de espejo reversible y 1 repisa y con luce led

С реверсивной зеркальной дверцей и 1 полочка и со

светодиодной подсветкой

**Acciaio inox, vetro e resine termoplastiche**

Stainless steel, glass and thermoplastic resins

Acier inoxydable, verre et résine thermoplastique

Edelstahl, Glas und Kunststoff

Acero inox, cristal y resinas termoplásticas

Ержавеющая сталь, стекла и термопластичных смол

## 2806 Banjo.

GEDY

L51 x P11,5 x H60 cm



13

Lucido  
Polished

100% MADE  
in Italy



Con anta a specchio reversibile e 1 ripiano

With reversible mirror door and 1 shelf

Avec porte à miroir réversible et 1 étagère

Mit reversibler Spiegeltür und 1 Ablage

Con puerta de espejo reversible y 1 repisa

С реверсивной зеркальной дверцей и 1 полочка

**Acciaio inox e vetro**

Stainless steel and glass - Acier inoxydable et verre

Edelstahl und Glas - Acero inox y cristal

Нержавеющей стали и стекла

## K007-01 Kora.

NEW

GEDY

L46 x P23,5 x H70,6 cm



13

Lucido/cromato  
Polished/chromed

CE

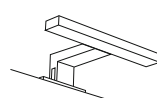

IP 44 - 230V-50Hz  
LED 3,62W - 6000K\*  
220 lumen - CRI 90



**Armadietto reversibile con antina**

**a specchio scorrevole, 3 ripiani e con luce led**

AISI  
304

Reversible cabinet with sliding mirror door, 3 shelves and led light

Armoire reversible avec porte à miroir coulissante, 3 tablettes et lumière led

Schrankchen reversibel mit Spiegel-Schiebetür, 3 Einlegeboden

und LED-Leuchten

Armario reversible con puerta de espejo corredera, 3 estantes y luce led

Шкафчик с зеркальной раздвижной дверцей нержавеющей,  
3 полки и со светодиодной подсветкой

**Acciaio inox AISI 304, vetro e resine termoplastiche**

AISI 304 stainless steel, glass and thermoplastic resins

Acier inoxydable AISI 304, verre et résine thermoplastique

Edelstahl AISI 304, Glas und Kunststoff

Acero inox AISI 304, cristal y resinas termoplásticas

Ержавеющая сталь AISI 304, стекла и термопластичных смол

## K007 Kora.

GEDY

L46 x P12 x H66 cm



### Armadietto reversibile con antina

#### a specchio scorrevole

Reversible cabinet with sliding mirror door  
Armoire reversible avec porte à miroir coulissante  
Schränkchen reversibel mit Spiegel-Schiebetür  
Armario reversible con puerta de espejo corredera  
Шкафчик с зеркальной раздвижной дверцей  
нержавеющая

AISI  
304

13  
Lucido  
Polished

### Acciaio inox AISI 304 e vetro

AISI 304 stainless steel and glass  
Acier inoxydable AISI 30 et verre  
Edelstahl AISI 304 und Glas  
Acero inox AISI 304 y cristal  
Ержавеющая сталь AISI 304 и стекла

## J007 Joker.

GEDY

L30 x P12 x H50 cm



### Armadietti con anta in vetro, serratura di sicurezza e 1 ripiano

Cabinets with glass door, safety lock and 1 shelf  
Armoires avec porte vitrée, serrure de sécurité  
Schränkchen mit Glastür, Sicherheitsschloss  
und 1 Ablage  
Armarios con puerta de cristal, cerradura  
de seguridad y 1 repisa  
Шкафчик со стеклянной створкой, замком и 1 полочка

13  
Lucido  
Polished

### Acciaio inox e vetro

Stainless steel and glass - Acier inoxydable et verre  
Edelstahl und Glas - Acero inox y cristal  
Ержавеющая сталь и стекла

## J035 Joker.

GEDY

L30 x P12 x H30 cm



### Armadietti con anta in vetro, serratura di sicurezza e 1 ripiano

Cabinets with glass door, safety lock and 1 shelf  
Armoires avec porte vitrée, serrure de sécurité  
Schränkchen mit Glastür, Sicherheitsschloss  
und 1 Ablage  
Armarios con puerta de cristal, cerradura  
de seguridad y 1 repisa  
Шкафчик со стеклянной створкой, замком и 1 полочка

13  
Lucido  
Polished

### Acciaio inox e vetro

Stainless steel and glass - Acier inoxydable et verre  
Edelstahl und Glas - Acero inox y cristal  
Ержавеющая сталь и стекла



## 8047 Princess.

GEDY

L58,5 x P14 x H38 cm

### Specchio contenitore

Vanity unit

Meuble à miroir

Spiegelschrank

Espejo contenedor

Зеркало-шкаф



### con 3 ante a specchio e 2 ripiani

with 3 mirror doors and 2 shelves

avec 3 portes à miroir et 2 tablettes

mit 3 Spiegeltüren und 2 Einlegeböden

con 3 puertas de espejo y 2 estantes

С 3 зеркальными дверцами и 2 полки

### Vetro e resine termoplastiche

Glass and thermoplastic resins

Verre et résine thermoplastique

Glas und Kunststoff

Cristal y resinas termoplásticas

Стекла и термопластичных смол

100% MADE  
in Italy



02

Bianco  
White



## 8006.8007 Lilliput.

GEDY

### Armadietto

#### con ripiani posizionabili

Cabinet with adjustable shelves

Armoire avec tablettes réglables

Kleiner Schrank mit positionierbaren

Einlegeböden

Armario con estantes regulables

Шкафчик с съемными полками



L30 x P14,3 x H45 cm

design Olaf Von Bohr

### 8006

#### Senza specchio

Without mirror - Sans miroir - Ohne Spiegel

Sin espejo - Без зеркальной створки

#### Resine termoplastiche

Thermoplastic resins - Résine thermoplastique

Kunststoff - Resinas termoplásticas - Термопластичных смол



02

Bianco  
White

### 8007

#### Con anta a specchio

With mirror door - Avec porte à miroir - Mit Spiegeltür

Con puerta de espejo - С зеркальной дверцей

#### Vetro e resine termoplastiche

Glass and thermoplastic resins - Verre et résine thermoplastique

Glas und Kunststoff - Cristal y resinas termoplásticas

стекла и термопластичных смол

## 8035 Jolly.

GEDY

L25 x P12,5 x H39,5 cm



### Armadietto farmacia con chiave e 1 ripiano

Medicine cabinet with key and 1 shelf

Armoire à pharmacie avec clef et 1 tablette

Arzneischrank mit Schlüssel und 1 Einlegeboden

Botiquín con llave y estante

Шкафчик-аптечка с ключом и 1 полкой

100% MADE  
in Italy



02

Bianco  
White

#### Resine termoplastiche

Thermoplastic resins - Résine thermoplastique

Kunststoff - Resinas termoplásticas

Термопластичных смол

# Illuminazione

Lighting - Luminaires - Licht im Bad  
Iluminación - Подсветка

## D040 Ibiza.



13  
Cromato  
Chromed

TOP DESIGN



### Lampada a Led con attacco universale a pinza per specchi senza cornice

LED light with universal socket and clip for mirror without frame

Lampe LED avec fixation universelle à pince pour miroirs sans cadre

Led-Leuchte mit universeller Klemmbefestigung für Spiegel ohne Rahmen

Lámpara de led con fijación universal de pinza para espejos sin marco

Светодиодная лампа с универсальным креплением на зеркала без рамы

### Cromall® e resine termoplastiche

Cromall® and thermoplastic resins

Cromall® et résine thermoplastique

Cromall® und Kunststoff

Cromall® y resinas termoplásticas

Сромалл® и термопластичных смол

L10 xP16,8 x H3,4 cm



CLASS EXEMPT GROUP

secondo norma EN 62471 - according with EN 62471

IP 44 - 230V-50Hz  
LED 4.4W - 420 Lumen  
3000°K - CRI 80



## D040-01 Ibiza.



13  
Cromato  
Chromed

TOP DESIGN

### Lampada a Led con telaio di fissaggio per specchi con cornice

LED lamp with fastening frame for framed mirrors

Lampe à leds avec cadre de fixation disposé pour les miroirs avec cadre

LED-Lampe mit Befestigungsrahmen für Spiegel mit Rahmen

Lámpara de led con bastidor de fijación predispuesto para espejos con marco

Светодиодная лампа с креплением на зеркала с рамой

### Cromall® e resine termoplastiche

Cromall® and thermoplastic resins

Cromall® et résine thermoplastique

Cromall® und Kunststoff

Cromall® y resinas termoplásticas

Сромалл® и термопластичных смол

L10 x P15,5 x H4,2 cm



CLASS EXEMPT GROUP

secondo norma EN 62471 - according with EN 62471

IP 44 - 230V-50Hz  
LED 4.4W - 420 Lumen  
3000°K - CRI 80



**Cromall® e resine termoplastiche**

Cromall® and thermoplastic resins

Cromall® et résine thermoplastique

Cromall® und Kunststoff

Cromall® y resinas termoplásticas

Сромалл® и термопластичных смол

## D041 Maiorca.



13  
Cromato  
Chromed

TOP DESIGN

**Lampada a Led con attacco universale a pinza per specchi senza cornice**

LED light with universal socket and clip for mirror without frame

Lampe LED avec fixation universelle à pince pour miroirs sans cadre

LED-Leuchte mit universeller Klemmbefestigung für Spiegel ohne Rahmen

Lámpara de led con fijación universal de pinza para espejos sin marco

Светодиодная лампа с универсальным креплением

на зеркала без рамы

L8,1 x P14,8 x H3,2 cm

CE

CLASS EXEMPT GROUP

secondo norma EN 62471 - according with EN 62471

IP 44 - 230V-50Hz  
LED 4.4W - 450 Lumen  
6000°K - CRI 90



**Cromall® e resine termoplastiche**

Cromall® and thermoplastic resins

Cromall® et résine thermoplastique

Cromall® und Kunststoff

Cromall® y resinas termoplásticas

Сромалл® и термопластичных смол

## D041-01 Maiorca.



13  
Cromato  
Chromed

TOP DESIGN

**Lampada a Led con telaio di fissaggio per specchi con cornice**

LED lamp with fastening frame for framed mirrors

Lampe à leds avec cadre de fixation disposé pour les miroirs avec cadre

LED-Lampe mit Befestigungsrahmen für Spiegel mit Rahmen

Lámpara de led con bastidor de fijación predispuesto

para espejos con marco

Светодиодная лампа с креплением на зеркала с рамой

L8,1 x P13,5 x H4,2 cm

CE

CLASS EXEMPT GROUP

secondo norma EN 62471 - according with EN 62471

IP 44 - 230V-50Hz  
LED 4.4W - 450 Lumen  
6000°K - CRI 90



**Resine termoplastiche**

Thermoplastic resins  
 Résine thermoplastique  
 Kunststoff  
 Resinas termoplásticas  
 Термопластичных смол

## D043 Kos.

TOP DESIGN



13  
**Cromato**  
 Chromed

**Lampada a Led con attacco universale per specchi con e senza cornice**

LED lamp with universal attachment for mirrors with or without frame

Lampe LED universelle pour miroirs avec ou sans cadre

LED-Lampe mit Universalbefestigung für Spiegel mit und ohne Rahmen

Lámpara de led con fijación universal para espejos con y sin marco

Силиконовые форсунки и микроотверстия, которые обеспечивают экономию воды и усиливают напор струи

**D043-30**

L30 x P10,3 x H3,5 cm  
 LED 7W - 680 lumen

**D043-50**

L50 x P10,3 x H3,5 cm  
 LED 9W - 660 lumen

CLASS EXEMPT GROUP  
 secondo norma EN 62471 - according with EN 62471

CE  
 IP 44 - RoHS - 220-240V  
 50-60 Hz - 6000°K - CRI >90



**Resine termoplastiche**

Thermoplastic resins  
 Résine thermoplastique  
 Kunststoff  
 Resinas termoplásticas  
 Термопластичных смол

## D043-51 Kos.

TOP DESIGN



13  
**Cromato**  
 Chromed

**Lampada a led per fissaggio a muro**

Wall fastening LED lamp

Lampe LED pour fixation murale

LED-Lampe für die Wandbefestigung

Lámpara de led para fijación a la pared

Светодиодная лампа для настенного крепления

L50 x P10,3 x H3,5 cm  
 LED 9W - 660 lumen

CLASS EXEMPT GROUP  
 secondo norma EN 62471 - according with EN 62471

CE  
 IP 44 - RoHS - 220-240V  
 50-60 Hz - 6000°K - CRI >90

# D042 Delos.

NEW

TOP DESIGN

## Lampada a Led con attacco per specchi senza cornice (max. 4,5 mm)

LED light with socket for mirror without frame (max. 4,5 mm)

Lampe LED avec fixation pour miroirs sans cadre (max. 4,5 mm)

Led-Leuchte mit Befestigung für Spiegel ohne Rahmen (max. 4,5 mm)

Lámpara de led con fijación para espejos sin marco (max. 4,5 mm)

Светодиодная лампа с креплением на зеркала без рамы (max. 4,5 mm)

CE

IP 44 - RoHS - 220-240 V  
50-60 Hz - 5600°K  
4,7W - 600 lumen - CRI > 90

CLASS EXEMPT GROUP  
secondo norma EN 62471 - according with EN 62471



### Resine termoplastiche

Thermoplastic resins

Résine thermoplastique

Kunststoff

Resinas termoplásticas

Термопластичных смол

∅ 8,8 x 9,7 cm



13  
**Cromato**  
Chromed



14  
**Nero matt**  
Matt black

## 4943 Madeira.

GEDY

### Lampada a Led con attacco universale per specchi con e senza cornice

LED lamp with universal fastening frame for mirrors with or without frame

Lampe LED universelle pour miroirs avec ou sans cadre

LED-Lampe mit Universalbefestigung für Spiegel mit und ohne Rahmen

Lámpara de led con fijación universal para espejos con y sin marco

Силиконовые форсунки и микроотверстия, которые обеспечивают экономию воды и усиливают напор струи

CE

IP 44 - RoHS

230V-50Hz - 6000°K - CRI 90

CLASSE ENERGETICA A  
CLASS EXEMPT GROUP A  
secondo normativa UE 874/2012  
according with UE 874/2012

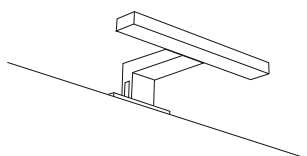

**4943**

L18 x P11,5 x H4,6 cm  
LED 3,62W - 220 lumen

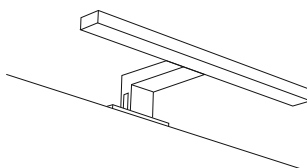

**4943-30**

L30 x P11,5 x H4,6 cm  
LED 4,9W - 330 lumen

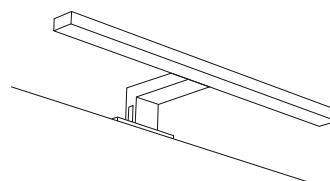

**4943-45**

L45 x P11,5 x H4,6 cm  
LED 8W - 450 lumen



13  
**Cromato**  
Chromed

## Specchi ingranditori

Magnifying mirrors - Miroirs grossissant - Beidseitiger Kosmetikspiegel  
Espejos de aumento - Увеличительное зеркало



### Acciaio inox e vetro

Stainless steel and glass

Acier inoxydable et verre

Edelstahl und Glas

Acero inox y cristal

нержавеющей стали и стекла

## 2118 Vincent.

TOP DESIGN

### Specchio ingranditore da parete con luce LED

Wall magnifying mirror with LED light

Miroir grossissant à mural avec lumière LED

Wand-Kosmetikspiegel mit LED-Leuchte

Espejo de aumento de pared con luz LED

Увеличительный зеркало

со светодиодной подсветкой

Ø 25 x P12,3/36 cm



13  
Cromato  
Chromed



Supporto  
estensibile

Extensible  
holder



IP 42 - 230V - 11W  
50Hz - 7400°K - 90 lumen - CRI 90



### Acciaio inox AISI 304, ottone e vetro

Chromed AISI 304 stainless steel, brass and glass

Acier inoxydable AISI 304 chromé, laiton et verre

Verchromtem Edelstahl AISI 304, Messing und Glas

Acero inox AISI 304 cromado, latón y cristal

Нержавеющей стали AISI 304, латуни и стекла

## 2100 Sarah.

TOP DESIGN

### Specchio ingranditore da parete con luce LED

Wall magnifying mirror with LED light

Miroir grossissant à mural avec lumière LED

Wand-Kosmetikspiegel mit LED-Leuchte

Espejo de aumento de pared con luz LED

Увеличительный зеркало

со светодиодной подсветкой

Ø 21,5x13/32 cm



13  
Cromato  
Chromed



14  
Nero matt  
Matt black



Supporto  
estensibile

Extensible  
holder



IP 44 - 110÷240V - 50/60Hz  
LED 1,6W - 300 lumen - 4000°K - CRI 91

## 2104 Michel.

TOP DESIGN

### Specchio ingranditore e non, bifacciale da parete

Two-way wall magnifying and non magnifying mirror

Miroir grossissant et non grossissant, double face

Spiegel mit und ohne Vergrößerung, zweiseitig

Espejo de aumento y normal, dos caras

Двустороннее зеркало, одна сторона с увеличением



Supporto  
estensibile

Extensible  
holder



Ø 18 cm

Ø 22,5 x P3-28,5 max. x H27,5 cm

### Acciaio inox AISI 304, ottone e vetro

Stainless steel AISI 304, brass and glass

Acier inoxydable AISI 304, laiton et verre

Edelstahl AISI 304, Messing und Glas

Acero inox AISI 304, latón y cristal

Нержавеющей стали AISI 304, латуни и стекло



13  
Cromato/lucido  
Chromed/polished



14  
Nero matt  
Matt black



## CO2024 Gaia.

NEW

GEDY

### Specchio ingranditore e non, bifacciale

Double-sided mirror with magnification on one side

Miroir grossissant et non grossissant, double face

Spiegel mit und ohne Vergrößerung, zweiseitig

Espejo de aumento y normal, dos caras

Двустороннее зеркало, одна сторона с увеличением



Supporto  
estensibile

Extensible  
holder



Ø 18 cm

23-25 x 2-29,5 max. x 30 cm

### Acciaio inox, vetro e Cromall®

Stainless steel, glass and Cromall®

Acier inoxydable, verre et Cromall®

Edelstahl, Glas und Cromall®

Acero inox, cristal y Cromall®

Нержавеющая сталь, стекло и Cromall®



13  
Cromato  
Chromed



14  
Nero matt  
Matt black



**Specchio orientabile**

**Adjustable mirror**



**Con ventosa With screws**

Resine termoplastiche e metallo  
Thermoplastic resins and metal  
Thermoplastique et métal  
Kunststoff und Metall  
Resinas termoplásticas y metal  
Термопластичных смол и металл

## H008 Hot.



13  
**Cromato**  
Chromed

**GEDY**

### Specchio ingranditore e non, bifacciale, con fissaggio a ventosa

Double-side magnifying and non-magnifying mirror with suction cup fixing  
Miroir double-face grossissant et non grossissant avec ventouse  
beidseitiger Kosmetikspiegel mit und ohne Vergrößerung mit Saugnapf-Befestigung  
Espejo de aumento y normal, dos caras fijación con ventosa  
Двустороннее увеличительное и не увеличительное зеркало  
Крепление при помощи присосок

L15 x 27 max x H22 cm

#### Solo su superfici lisce e non porose

For smooth, non-porous surfaces only - Uniquement sur des surfaces lisses et non poreuses - Nur auf glatten, nicht porösen Oberflächen  
Solo en superficies lisas y no porosas - Только для гладких и непористых поверхностей

## C02021. C02020 Lia.



13  
**Cromato**  
Chromed

**GEDY**

### Specchio ingranditore da parete con ventose

Wall magnifying mirror with suction cups  
Miroir grossissant avec à mural ventouses  
Wand-Kosmetikspiegel mit Saugnapfen  
Espejo de aumento de pared con ventosas  
Двустороннее увеличительное с Крепление при помощи присосок

**C02021**

Ø 20 x 3 cm



**C02020**

Ø 15 x 3 cm



#### Solo su superfici lisce e non porose

For smooth, non-porous surfaces only - Uniquement sur des surfaces lisses et non poreuses - Nur auf glatten, nicht porösen Oberflächen  
Solo en superficies lisas y no porosas - Только для гладких и непористых поверхностей



Metallo  
Metal  
Métal  
Metall  
Metal  
Металл



**Con ventosa With screws**

## CO2019 Ada.

GEDY

L20 x P11,8 x H32,3 cm

**Metallo**

Metal - Métal - Metall

Metal - Metall



**Specchio ingranditore e non, bifacciale**

Two way magnifying and non magnifying mirror

Miroir grossissant et non grossissant, double face  
beidseitiger Kosmetikspiegel mit und ohne Vergrößerung

Espejo de aumento y normal, dos caras

Двустороннее увеличительное

и не увеличительное зеркало



13  
**Cromato**  
Chromed

## CO2023 Monica.

GEDY

L17,2 x P3,9 x H17,5 cm

**Metallo**

Metal - Métal - Metall

Metal - Metall



**Specchio ingranditore e non, bifacciale**

Two way magnifying and non magnifying mirror

Miroir grossissant et non grossissant, double face  
beidseitiger Kosmetikspiegel mit und ohne Vergrößerung

espejo de aumento y normal, dos caras

Двустороннее увеличительное

и не увеличительное зеркало



02  
**Bianco**  
White



13  
**Cromato**  
Chromed

## CO2022 Elena.

GEDY

L16,5 x P1,8 x H19 cm

**Resine termoplastiche**

Thermoplastic resins

Thermoplastique - Kunststoff

Resinas termoplásticas термопластичных смол



**Specchio ingranditore e non, bifacciale**

Two way magnifying and non magnifying mirror

miroir grossissant et non grossissant, double face

beidseitiger Kosmetikspiegel mit und ohne

Vergrößerung

espejo de aumento y normal, dos caras

Двустороннее увеличительное и обычное зеркало



02  
**Bianco**  
White



76  
**Fucsia**  
Fuchsia



92  
**Turchese**  
Turquoise

## CO2018.

GEDY

L17,6 x P10 x H25 cm

**Resine termoplastiche**

Thermoplastic resins

Thermoplastique - Kunststoff

Resinas termoplásticas термопластичных смол



**Specchio ovale ingranditore e non, bifacciale**

Oval two way magnifying and non magnifying mirror

Miroir ovale grossissant et non grossissant, double face

Ovaler beidseitiger Kosmetikspiegel mit und ohne Vergrößerung

Espejo ovalado de aumento y normal, dos caras

Двустороннее увеличительное и обычное зеркало



00  
**Trasparente**  
Transparent



05  
**Blu**  
Blue



79  
**Lilla**  
Lilac

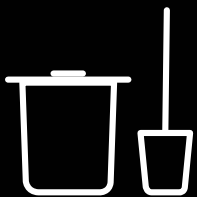

# ACCESSORI WC

Wc accessories





## Poubelles in acciaio inox

Stainless steel waste baskets - Corbeilles en acier inoxydable

Treiteimer aus Edelstahl - Cubos de basura en acero inox

Урны из нержавеющей стали



13  
**Lucido**  
Polished

TOP DESIGN

**5209 Vesta - 6,6 lt**

ø18,8 x H25 cm



13  
**Lucido**  
Polished

GEDY

**2809 Argenta - 5 lt**

L22,8 x P23,2 x H30 cm



13  
**Lucido**  
Polished

GEDY

**2909 Argenta - 5 lt**

L14 x P29,4 x H30 cm



13  
**Lucido**  
Polished



14  
**Nero matt**  
Matt Black

GEDY

**2209 Argenta - 3 lt**

L16,5 x P21,5 x H25 cm



Soft  
close



13  
**Lucido**  
Polished



14  
**Nero matt**  
Matt Black

GEDY

**2309 Argenta - 5 lt**

L20,5 x P24 x H30 cm



Soft  
close

Poubelles in acciaio inox - Stainless steel waste baskets.



13  
Lucido  
Polished

GEDY

**2409 Argenta - 7 lt**

L20,5 x P26,5 x H31,8 cm



13  
Lucido  
Polished

GEDY

**2609 Argenta - 3 lt**

L17 x P22,5 x H26 cm



13  
Lucido  
Polished

GEDY

**2709 Argenta - 5 lt**

L20,5 x P26,5 x H27,8 cm



13  
Lucido  
Polished

GEDY

**3009 Grid - 3 lt**

L17 x P22,5 x H26 cm



## Potty.

GEDY



Soft close



02  
Bianco matt  
Matt white



14  
Nero matt  
Matt black



38  
Spazzolato  
Brushed



87  
Oro matt  
Matt gold



**3309 - 5 lt**

L20,6 x P26,8 x H27,5 cm



**3209 - 3 lt**

L17,4 x P22,6 x H25,1 cm



**Kenta.**

**bambocom®**

GEDY



40

Naturale/Bianco matt  
Natural/Matt white



41

Naturale/Nero matt  
Natural/Matt black

**Realizzate in bambù e metallo**

Made of bamboo and metal

Réalisés en bambou et métal

Hergestellt aus Bambus und Metall

Realizadas en bambù y metal

Изготовлено из бамбука и металл



Natural



Save  
the planet



Bambù  
Bamboo



**1409 - 5 lt**

ø 20,5 x 26 x 26,5 cm



**1309 - 3 lt**

ø 17 x 22 x 25 cm



Soft close



# Poubelles in resine termoplastiche

Waste baskets in thermoplastic resins - Poubelles en résine thermoplastique  
 Treteimer aus Kunststoff - Papeleras en resinas termoplásticas  
 Урны из термопластичных смол

100% MADE  
 in **Italy**



ACCESSORI WC  
 Wc accessories



design  
**Makio  
 Hasuike**



02  
**Bianco**  
 White

**GEDY**

**2009 Boxer - 10,8 lt**

ø 22,5 x H31 cm



design  
**Pedrizetti  
 e Associati**



24  
**Bianco/Nero**  
 White/Black

**GEDY**

**1009 Peng - 7,5 lt**

L22,9 x P23,8 x H34,5 cm



00  
**Trasparente**  
 Transparent



02  
**Bianco**  
 White

**GEDY**

**GL09 Glady - 6,6 lt**

ø 21,1 x H25,4 cm



design  
**Olaf Von Bohr**



02  
**Bianco**  
 White



08  
**Grigio**  
 Grey



52  
**Tortora**  
 Turtledove  
 grey



65  
**Blu petrolio**  
 Petrol blue



66  
**Beige**  
 Beige



86  
**Celeste**  
 Sky blue

**GEDY**

**8009 Junior - 4,8 lt**

L21 x P15 x H33 cm



P2  
**Bianco**  
 White

**GEDY**

**8609 Venezia - 6 lt**

ø 23 x H24,5 cm

# Seventy.

GEDY



08  
Grigio  
Grey



22  
Bianco  
White



27  
Acquamarina  
Aquamarine



52  
Tortora  
Turtledove



65  
Blu petrolio  
Petrol blue



66  
Beige  
Beige



86  
Celeste  
Sky blue

100% MADE  
in Italy



**6309 - 8 lt**

L20 x P20 x H24,6 cm



**6308 - 1,2 lt**

L11,6 x P11,6 x H12,4 cm

### Poubelle da tavolo

Table basket

Poubelle de table

Tischabfalleimer

Papelera de mesa

Контейнер для

мусора настольный

Poubelles in resine termoplastiche - Waste baskets in thermoplastic resins.

**Eye.**

GEDY



02  
**Bianco**  
White



08  
**Grigio**  
Grey



66  
**Beige**  
Beige

**100% MADE**  
in **Italy**



**1209 - 6 lt**  
ø 19 x H26,5 cm

## Scopini wc da muro

Wall toilet brush holders  
Porte-brosses wc mural  
Wand-WC-Bürstengarnituren  
Escobilleros de pared  
Настенный, Туалетный ершик



15  
YEARS

GARANZIA  
WARRANTY



TOP DESIGN

**5433-03 Lounge**

L8,2 x P11,2 x H40 cm

### Acciaio inox, Cromall® e alluminio

Stainless steel, Cromall® and alluminio

Acier inoxydable, Cromall® et aluminium

Edelstahl, Cromall® und aluminium

Acero inox, Cromall® y aluminio

нержавеющая сталь, Cromall® и алюминий



13  
**Cromato**  
Chromed



14  
**Nero matt**  
Matt Black

15  
YEARS

GARANZIA  
WARRANTY



TOP DESIGN

**7633-03 Bridge**

design Carlo Martino

L8 x P10 x H40,5 cm

### Acciaio inox AISI 304, Cromall® e ottone

AISI 304 stainless steel, Cromall® and brass

Acier inoxydable AISI 304, Cromall® et laiton

Edelstahl AISI 304, Cromall® und Messing

Acero inox AISI 304, Cromall® y latón

нержавеющей стали AISI 304, Cromall® и латунные

Scopini wc da muro - Wall toilet brush holders .

15  
YEARS  
GARANZIA  
WARRANTY

AISI  
304



TOP DESIGN

**3233-03 Outline**

design Simone Micheli

L8 x P10 x H38,4 cm



13  
**Cromato**  
Chromed



22  
**Bianco matt**  
Matt white



14  
**Nero matt**  
Matt Black

15  
YEARS  
GARANZIA  
WARRANTY



TOP DESIGN

**2433-03 Perseo**

L8,5 x P8,7 x H35,9 cm



13  
**Cromato**  
Chromed

**Acciaio inox AISI 304, Cromall®, ottone e resine termoplastiche**

AISI 304 stainless steel, Cromall®, brass and thermoplastic resins

Acier inoxydable AISI 304, Cromall®, laiton et thermoplastique

Edelstahl AISI 304, Cromall®, Messing und Kunststoff

Acero inox AISI 304, Cromall®, latón y resinas termoplásticas

нержавеющей стали AISI 304, Cromall®, латунные и термопластичные смолы

**Ottone**

Brass

Laiton

Messing

Latón

Латунные



RETAIL

**4434-03 Teseo**

L9 x P9 x H38 cm



13  
**Lucido**  
Polished



14  
**Nero matt**  
Matt black

15  
YEARS  
GARANZIA  
WARRANTY

100%  
AISI  
304



CONTRACT

**5034-03 Project**

L8,6 x P9,5 x H37,9 cm



13  
**Lucido**  
Polished



38  
**Spazzolato**  
Brushed

**Acciaio inox**

Stainless steel

Acier inoxydable

Edelstahl

Acero inox

нержавеющая сталь

**Acciaio inox AISI 304**

AISI 304 stainless steel

Acier inoxydable AISI 304

Edelstahl AISI 304

Acero inox AISI 304

нержавеющей стали AISI 304

ACCESSORI WC . WC ACCESSORIES .



GEDY

**NE33-03 Nemesia**

L9 x P9 x H38 cm

**Acciaio inox**

Stainless steel

Acier inoxydable

Edelstahl

Acero inox

нержавеющая сталь



13  
**Lucido**  
Polished



GEDY

**ED34-03 Edera**

L7,7 x P8,5 x H40,3 cm

**Acciaio inox**

Stainless steel

Acier inoxydable

Edelstahl

Acero inox

нержавеющая сталь



13  
**Lucido**  
Polished

**Flip.**

GEDY



02  
**Bianco**  
White



13  
**Lucido**  
Polished



14  
**Nero matt**  
Matt black



22  
**Bianco matt**  
Matt white



**5233-03**

L9,1 x P10 x H37,7 cm

**Acciaio inox**

Stainless steel

Acier inoxydable

Edelstahl

Acero inox

нержавеющая сталь

Scopini wc da muro - Wall toilet brush holders .



10  
YEARS  
GARANZIA  
WARRANTY



GEDY

**PI33-03 Pirenei**

L8,4 x P10,4 x H37 cm

**Cromall® e vetro**

Cromall® and glass

Cromall® et verre

Cromall® und Glas

Cromall® y cristal

Cromall® и стекла



13  
**Cromato**  
Chromed



14  
**Nero matt**  
Matt Black



02  
**Bianco matt**  
Matt white

NEW



38  
**Spazzolato**  
Brushed

NEW



87  
**Oro**  
Gold

NEW



88  
**Oro matt**  
Matt gold

TRATTAMENTO PVD  
PVD PLATED

15  
YEARS  
GARANZIA  
WARRANTY



GEDY

**5733-03 Glamour**

L10 x P13 x H39 cm

**Cromall® e vetro**

Cromall® and glass

Cromall® et verre

Cromall® und Glas

Cromall® y cristal

Cromall® и стекла



13  
**Cromato**  
Chromed

100% MADE  
in Italy



GEDY

**8533-03 Oscar**

L11 x P15,8 x H35 cm



02  
**Bianco**  
White



Con viti  
With screws



Con biadesivo  
With double  
sided tape

**design Matteo Thun**

**Resine termoplastiche**

Thermoplastic resins

Thermoplastique

Kunststoff - Resinas termoplásticas

Термопластичные смолы



**Biagio.**

**NEW**

GEDY



Con biadesivo  
With double  
sided tape



GARANZIA  
WARRANTY



02  
Bianco  
White



38  
Spazzolato  
Brushed



**Scopino da terra e  
da muro con spatola**

Toilet brush holder freestanding  
and wall mounted with spatula  
Porte-brosse WC à poser et  
mural avec spatule  
Wand-WC-Bürstengarnitur  
zum Aufstellen oder  
Aufhängen mit Schaber  
Escobillero de suelo y  
de pared con espátula  
Напольный и  
настенный туалетный  
ершик с насадкой-скребком



**6833**

L11,4 x P7,7 x H45 cm



**Acciaio inox e resine termoplastiche**

Stainless steel and thermoplastic resins  
Acier inoxydable et résine thermoplastique  
Edelstahl und kunststoff  
Acero inox y resinas termoplasticas  
Нержавеющая сталь  
и термопластичные смолы





## Scopini wc

Toilet brush holders - Porte-brosses wc  
WC-Bürstengarnituren  
Escobilleros - Туалетный ершик



15  
YEARS

GARANZIA  
WARRANTY



TOP DESIGN

**5433 Lounge**

L8,2 x P8,2 x H40 cm

### Acciaio inox e alluminio

Stainless steel and aluminium

Acier inoxydable et aluminium

Edelstahl und aluminium

Acero inox y aluminio

Нержавеющая сталь и алюминий



13  
**Cromato**  
Chromed



14  
**Nero matt**  
Matt Black

15  
YEARS

GARANZIA  
WARRANTY



TOP DESIGN

**A033 Elba**

L9,6 x P9,6 x H39,5 cm

### Ottone, alluminio e vetro

Brass, aluminium and glass

Laiton, aluminium et verre

Messing, aluminium und Glas

Latón, aluminio y cristal

Латунные, алюминий и стекла



13  
**Cromato**  
Chromed

15  
YEARS

GARANZIA  
WARRANTY



13  
**Cromato**  
Chromed

TOP DESIGN

**A233 Canarie**

∅ 10 x H47 cm

**Acciaio inox**

Stainless steel - Acier inoxydable

Edelstahl - Acero inox - Нержавеющая сталь



**Manico telescopico**

Telescopic handle  
Manche télescopique  
Ausziehbarem Stiel  
Mango telescópico  
Телескопической ручкой

15  
YEARS

GARANZIA  
WARRANTY



13  
**Cromato**  
Chromed

TOP DESIGN

**7633 Bridge**

**design Carlo Martino**

L8 x P8 x H40,5 cm

**Acciaio inox**

Stainless steel

Acier inoxydable

Edelstahl

Acero inox

Нержавеющая сталь

15  
YEARS

GARANZIA  
WARRANTY



13  
**Cromato**  
Chromed



22  
**Bianco matt**  
Matt white



14  
**Nero matt**  
Matt black

AISI  
304

TOP DESIGN

**3234 Outline**

**design Simone Micheli**

L8 x P8 x H38,4 cm

**Acciaio inox AISI 304, Cromall®, ottone e resine termoplastiche**

AISI 304 stainless steel, Cromall®, brass and thermoplastic resins

Acier inoxydable AISI 304, Cromall®, laiton et thermoplastique

Edelstahl AISI 304, Cromall®, Messing und Kunststoff

Acero inox AISI 304, Cromall®, latón y resinas termoplásticas

Нержавеющей стали AISI 304, Cromall®, латунные и термопластичные смолы

15  
YEARS

GARANZIA  
WARRANTY



13  
**Cromato**  
Chromed

AISI  
304

TOP DESIGN

**5633 Ulisse**

L8,1 x P8,1 x H40 cm

**Acciaio inox AISI 304 e resine termoplastiche**

AISI 304 stainless steel and thermoplastic resins

Acier inoxydable AISI 304 et thermoplastique

Edelstahl AISI 304 und Kunststoff

Acero inox AISI 304 y resinas termoplásticas

Нержавеющая сталь AISI 304 и термопластичные смолы

10  
YEARS

GARANZIA  
WARRANTY



RETAIL

**4433 Teseo**

L9,6 x P9,6 x H37,2 cm

**Acciaio inox**

Stainless steel

Acier inoxydable

Edelstahl

Acero inox

нержавеющая сталь



13  
**Lucido**  
Polished



14  
**Nero matt**  
Matt Black

15  
YEARS

GARANZIA  
WARRANTY



CONTRACT

**5034 Project**

ø 8,6 x H37,9 cm

**Acciaio inox AISI 304**

AISI 304 stainless steel

Acier inoxydable AISI 304

Edelstahl AISI 304

Acero inox AISI 304

нержавеющей стали AISI 304

100%  
AISI  
304



13  
**Lucido**  
Polished



38  
**Spazzolato**  
Brushed

10  
YEARS

GARANZIA  
WARRANTY



GEDY

**7533 Romance**

ø 9 x H41 cm

**Acciaio inox e Cromall®**

Stainless steel and Cromall®

Acier inoxydable et Cromall®

Edelstahl und Cromall®

Acero inox y Cromall®

Нержавеющей стали и Cromall®



44  
**Bronzo**  
Bronze



GEDY

**3833 Kansas**

L8,7 x P8,7 x H36 cm

**Acciaio inox**

Stainless steel

Acier inoxydable

Edelstahl

Acero inox

нержавеющая сталь



13  
**Lucido**  
Polished



GEDY

**EE33 Elettra**

ø 8 x H46,8 cm



15  
**Rame**  
Copper



GEDY

**2634 John**

ø 8 x H38 cm



13  
**Cromato**  
Chromed



14  
**Nero matt**  
Matt Black

**Acciaio inox**

Stainless steel  
Acier inoxydable  
Edelstahl  
Acero inox  
нержавеющая сталь

**Acciaio inox e resine termoplastiche**

Stainless steel and thermoplastic resins  
Acier inoxydable et thermoplastique  
Edelstahl und Kunststoff  
Acero inox y resinas termoplásticas  
нержавеющая сталь и термопластичные смолы

10  
YEARS

GARANZIA  
WARRANTY



GEDY

**2333 Argo**

ø 9 x H39 cm



13  
**Lucido**  
Polished

10  
YEARS

GARANZIA  
WARRANTY



GEDY

**3633 Mercurio**

ø 8,3 x H33,6 cm



13  
**Cromato**  
Chromed

**Acciaio inox**

Stainless steel  
Acier inoxydable  
Edelstahl  
Acero inox  
нержавеющая сталь

**Acciaio inox**

Stainless steel  
Acier inoxydable  
Edelstahl  
Acero inox  
нержавеющая сталь



13  
Lucido  
Polished



GARANZIA  
WARRANTY



13  
Lucido  
Polished

GEDY

**2133 Winny**

ø 9 x H39 cm

**Acciaio inox**

Stainless steel

Acier inoxydable

Edelstahl

Acero inox

нержавеющая сталь

GEDY

**EP33 Edera Plus**

ø 7,9 x H33,2 cm

**Acciaio inox**

Stainless steel

Acier inoxydable

Edelstahl

Acero inox

нержавеющая сталь



13  
Lucido  
Polished

GEDY

**NE33 Nemesia**

L9 x P9 x H38 cm

**Acciaio inox**

Stainless steel

Acier inoxydable

Edelstahl

Acero inox

нержавеющая сталь



21  
Lucido/Spazzolato  
Polished/Brushed

GEDY

**PR33 Primula**

ø 10 x H38 cm

**Acciaio inox**

Stainless steel

Acier inoxydable

Edelstahl

Acero inox

нержавеющая сталь

10  
YEARS

GARANZIA  
WARRANTY



GEDY

**ED34 Edera**

ø 7,5 x H40 cm



13  
**Lucido**  
Polished

**Acciaio inox**

Stainless steel

Acier inoxydable

Edelstahl

Acero inox

нержавеющая сталь



GEDY

**GE33 Genziana**

ø 8 x H33,3 cm



02  
**Bianco**  
White



13  
**Lucido**  
Polished

**Acciaio inox**

Stainless steel

Acier inoxydable

Edelstahl

Acero inox

нержавеющая сталь



GEDY

**FE33 Felce**

ø 8 x H33,3 cm



13  
**Lucido**  
Polished

**Acciaio inox**

Stainless steel

Acier inoxydable

Edelstahl

Acero inox

нержавеющая сталь



GEDY

**2733 Ascot**

ø 9,1 x H38,6 cm



13  
**Lucido**  
Polished

**Acciaio inox**

Stainless steel

Acier inoxydable

Edelstahl

Acero inox

нержавеющая сталь



GEDY

**5233 Flip**

ø 9,1 x H37,7 cm



02  
**Bianco**  
White



14  
**Nero matt**  
Matt black



13  
**Lucido**  
Polished



22  
**Bianco matt**  
Matt white

**Acciaio inox**

Stainless steel

Acier inoxydable

Edelstahl

Acero inox

нержавеющая сталь



GEDY

**DS33 Diaspro**

ø 10 x H39 cm



13  
**Lucido**  
Polished

**Acciaio inox**

Stainless steel

Acier inoxydable

Edelstahl

Acero inox

нержавеющая сталь



GEDY

**C034 Oriente**

ø 9,5 x H37 cm



13  
**Lucido**  
Polished

**Acciaio inox e resine termoplastiche**

Stainless steel and thermoplastic resins

Acier inoxydable et thermoplastique

Edelstahl und Kunststoff

Acero inox y resinas termoplásticas

нержавеющая сталь и термопластичные смолы



GEDY

**1133 Ralph**

ø 9,6 x H37,6 cm



13  
**Lucido**  
Polished

**Acciaio inox e resine termoplastiche**

Stainless steel and thermoplastic resins

Acier inoxydable et thermoplastique

Edelstahl und Kunststoff

Acero inox y resinas termoplásticas

нержавеющая сталь и термопластичные смолы

15  
YEARS

GARANZIA  
WARRANTY



GEDY

**5533 Kent**

L9,7 x P9 x H36,2 cm

**Cromall® e vetro**

Cromall® and glass

Cromall® et verre

Cromall® und Glas

Cromall® y cristal

Cromall® и стекла



13  
**Cromato**  
Chromed

15  
YEARS

GARANZIA  
WARRANTY



GEDY

**5733 Glamour**

L10 x P10 x H39 cm

**Cromall® e vetro**

Cromall® and glass

Cromall® et verre

Cromall® und Glas

Cromall® y cristal

Cromall® и стекла



02  
**Bianco**  
White



GEDY

**PE33 Petunia**

∅ 9 x H44,8 cm

**Acciaio inox,ceramica e resine termoplastiche**

Stainless steel, pottery and thermoplastic resins

Acier inoxydable, céramique et thermoplastique

Edelstahl, Keramik und Kunststoff

Acero inox, cerámica y resinas termoplásticas

Нержавеющая сталь, керамики и термопластичные смолы



02  
**Bianco**  
White



GEDY

**VE33 Verbena**

L7,8 x P7,8 x H45,6 cm

**Acciaio inox,ceramica e resine termoplastiche**

Stainless steel, pottery and thermoplastic resins

Acier inoxydable, céramique et thermoplastique

Edelstahl, Keramik und Kunststoff

Acero inox, cerámica y resinas termoplásticas

Нержавеющая сталь, керамики и термопластичные смолы



Scopini wc - Toilet brush holders .

**Oscar.**

100% MADE  
in Italy



02  
**Bianco**  
White



14  
**Nero matt**  
Matt black



P0  
**Rosa**  
Pink



P1  
**Azzurro**  
Light blue



P2  
**Bianco opalino**  
Opaline white



P7  
**Acquamarina opalino**  
Opaline aquamarine

design Matteo Thun



08  
**Grigio**  
Grey



66  
**Beige**  
Beige



65  
**Blu petrolio**  
Petrol blue



27  
**Acquamarina**  
Aquamarine



86  
**Celeste**  
Sky blue



22  
**Bianco lucido**  
Polished white



**8833**

ø 13 x H35 cm

**Resine termoplastiche**

Thermoplastic resins

Thermoplastique

Kunststoff

Resinas termoplásticas

Термопластичные смолы

**Peter.**

100% MADE  
in Italy



GEDY



08  
Grigio  
Grey



22  
Bianco  
White



52  
Tortora  
Turtledove  
grey



65  
Blu petrolio  
Petrol blue



66  
Beige  
Beige



86  
Celeste  
Sky blue



**Resine termoplastiche**

Thermoplastic resins

Thermoplastique

Kunststoff

Resinas termoplásticas

Термопластичные смолы



**6033**

ø 14 x H41 cm

**Junior.**

100% MADE  
in Italy



GEDY



02  
Bianco  
White



08  
Grigio  
Grey



52  
Tortora  
Turtledove  
grey



65  
Blu petrolio  
Petrol blue



66  
Beige  
Beige



86  
Celeste  
Sky blue

design Giampiero Tonetti



**Resine termoplastiche**

Thermoplastic resins

Thermoplastique

Kunststoff

Resinas termoplásticas

Термопластичные смолы



**8034**

ø 12,5 x H37,5 cm

Scopini wc - Toilet brush holders .

**Seventy.**

100% MADE  
in Italy



GEDY

design R & S Gedy



08  
**Grigio**  
Grey



22  
**Bianco**  
White



27  
**Acquamarina**  
Aquamarine



52  
**Tortora**  
Turtledove  
grey



65  
**Blu petrolio**  
Petrol blue



66  
**Beige**  
Beige



79  
**Lilla**  
Lilac



86  
**Celeste**  
Sky blue



V7  
**Verde pistacchio**  
Pistachio green



**6334**

L9 x P9 x H38,8 cm

**Resine termoplastiche**

Thermoplastic resins

Thermoplastique

Kunststoff

Resinas termoplásticas

Термопластичные смолы

ACCESSORI WC . WC ACCESSORIES .

# Cucciolo.

GEDY

design Makio Hasuike

2033

ø 15 x H33,5 cm



02  
Bianco  
White

100% MADE  
in Italy



**MoMA** June 27, 1977  
In permanent Design Collection  
of the Museum of Modern Art  
in New York



**Dal 1977 fa parte  
della collezione  
permanente di design  
del MOMA di New York.**

**Since 1977 it has been part  
of the permanent collection  
of design at the MOMA  
New York City.**



# CUCCILO LIMITED EDITION

70  
Years  
1953  
2023

**In occasione dei 70 anni della fondazione dell'Azienda, Gedy lancia in edizione limitata e numerata il suo Icon Item Cucciolo.**

**Con un packaging celebrativo, lo scopino Cucciolo si veste di nuovo in una tiratura di soli 1000 pezzi.**

Gedy launches its icon item Cucciolo in a limited and numbered edition, on occasion of Company's 70th Anniversary.

The toilet brush holder gets a new look in an edition of only 1000 pieces with a celebratory packaging.



Seventy. **EK**recpla

**NEW**

**GEDY**



Save the planet



Riciclabile  
Recyclable



Riciclato  
Recycled

100% MADE  
in **Italy**



08  
Grigio matt  
Matt grey



14  
Nero matt  
Matt black



22  
Bianco matt  
Matt white



07  
Verde matt  
Matt green



17  
Verde salvia matt  
Matt green sage



**6333**

L9 x P9 x H38,8 cm

**Materiale plastico riciclato**

Recycled plastic

Plastique recyclé

Recyceltes Kunststoffmaterial

Material plástico reciclado

Переработанный пластик

Scopini wc - Toilet brush holders .



GEDY

**1733 Flou**

ø 12,6 x H36 cm



02  
**Bianco**  
White



92  
**Turchese  
trasparente**  
Transparent  
turquoise

**design Carallo - Grandis**

**Resine termoplastiche**

Thermoplastic resins

Thermoplastique

Kunststoff

Resinas termoplásticas

Термопластичные смолы



GEDY

**3133 Moby**

L11 x P10,9 x H37,8 cm



02  
**Bianco**  
White

**100% MADE  
in Italy**



**design Babled & Co.**

**Resine termoplastiche**

Thermoplastic resins

Thermoplastique

Kunststoff

Resinas termoplásticas

Термопластичные смолы



GEDY

**8033 Junior**

ø 13,5 x H39 cm



02  
**Bianco**  
White

**100% MADE  
in Italy**



**design Giampietro Tonetti**

**Resine termoplastiche**

Thermoplastic resins

Thermoplastique

Kunststoff

Resinas termoplásticas

Термопластичные смолы



GEDY

**ZE33 Zeno**

ø 12,2 x H37,6 cm



02  
**Bianco**  
White

**100% MADE  
in Italy**



**Resine termoplastiche**

Thermoplastic resins

Thermoplastique

Kunststoff

Resinas termoplásticas

Термопластичные смолы



## Sedili wc

Toilet seats - Abattants - WC-Sitze  
Asientos de inodoro - Туалетное сиденье



### 4026 Corniola.

GEDY

Realizzato in MDF con laccatura epossidica e cerniere in Cromall®  
Made of epoxy lacquered M.D. with hinges Cromall®  
Réalisé en M.D. avec laquage époxy et fixations en Cromall®  
Hergestellt aus M.D. mit Epoxid-Beschichtung mit Befestigungen aus Cromall®  
Realizado en DM pintado epoxi y bisagras de Cromall®  
Туалетное сиденье из МДФ, покрытие эпоксидным лаком и петли из Cromall®



L37 x P47 x H7 cm



Soft close  
Soft close



Fissaggio veloce  
Fast fix



Universale  
Universal



02  
Bianco  
White



02  
Bianco  
White



Universale  
Universal



L37 x P44 x H5,8 cm

### 4007 Smeraldo.

GEDY

Realizzato in MDF con laccatura epossidica e cerniere in ottone cromato  
Made of epoxy lacquered M.D. with chromed brass hinges  
Réalisé en M.D. avec laquage époxy et fixations en laiton chromé  
Hergestellt aus M.D. mit Epoxid-Beschichtung mit Befestigungen aus verchromtem Messing  
Realizado en DM pintado epoxi y bisagras de latón cromado  
Туалетное сиденье из МДФ покрытие эпоксидным лаком и хромированные латунные петли



## 4029 Acquamarina.

GEDY

Realizzato in MDF e cerniere in Cromall®  
 Made of M.D. with Cromall® hinges  
 Réalisé en M.D. et fixations en Cromall®  
 Hergestellt aus M.D. mit Befestigungen aus Cromall®  
 Realizado en DM y bisagras de Cromall®  
 Туалетное сиденье из МДФ с петлями из Cromall®



L35,5 x P43 x H5,8 cm



Universale  
 Universal



02  
 Bianco  
 White



Universale  
 Universal



02  
 Bianco  
 White



L36,8 x P45,4 x H5,4 cm

## 4025 Agata.

GEDY

Realizzato in MDF con laccatura epossidica e cerniere in polipropilene  
 Made of epoxy lacquered M.D. with polypropylene hinges  
 Réalisé en M.D. avec laquage époxy et fixations en polypropylène  
 Hergestellt aus M.D. mit Epoxid-Beschichtung mit Befestigungen aus Polypropylen  
 Realizado en DM pintado epoxi con bisagras de polipropileno  
 Туалетное сиденье из МДФ, покрытие эпоксидным лаком и полипропиленовые петли



02  
 Bianco  
 White

## 4009 Rubino.

GEDY

Sedile WC per sanitari modello disabili, realizzato in MDF con laccatura epossidica e cerniere in ottone cromato  
 Toilet seat for disabled model bathroom fittings made of epoxy lacquered M.D. with chromed brass hinges  
 Abattant pour sanitaires modèle porteurs de handicap réalisé en M.D. avec laquage époxy et fixations en laiton chromé  
 WC-Sitz für Modell Behinderte, Hergestellt aus M.D. mit Epoxid-Beschichtung mit Befestigungen aus verchromtem Messing  
 Asiento inodoro para sanitarios para minusválidos realizado en DM pintado epoxi y bisagras de latón cromado  
 Сиденье для унитаза модели для инвалидов туалетное сиденье из МДФ покрытие эпоксидным лаком и хромированные латунные петли



L36,5 x P45,5 x H6 cm



Fissaggio  
 inclinato a 45°  
 Fastening 45°



02  
 Bianco  
 White



L34 x P46 x H5 cm

## 4022.

GEDY

Sedile WC per sanitari modello Conca, realizzato in MDF con laccatura epossidica e cerniere in ottone cromato  
 Toilet seat for Conca sanitary fixtures made of epoxy lacquered M.D. with chromed brass hinges  
 Abattant pour sanitaires modèle Conca réalisé en M.D. avec laquage époxy et fixations en laiton chromé  
 WC-Sitz für Modell Conca, Hergestellt aus M.D. mit Epoxid-Beschichtung mit Befestigungen aus verchromtem Messing  
 Asiento de inodoro para sanitarios modelo Conca realizado en DM pintado epoxi y bisagras de latón cromado  
 Сиденье для унитаза модели Conca, туалетное сиденье из МДФ покрытие эпоксидным лаком и хромированные латунные петли

## 4023.

GEDY

Sedile WC per sanitari modello Tesi, realizzato in MDF con laccatura epossidica e cerniere in ottone cromato

Toilet seat for Tesi sanitary fixtures made of epoxy lacquered M.D. with chromed brass hinges

Abattant pour sanitaires modèle Tesi réalisé en M.D. avec laquage époxy et fixations en laiton chromé

WC-Sitz für Modell Tesi, Hergestellt aus M.D. mit Epoxid-Beschichtung mit Befestigungen aus verchromtem Messing

Asiento de inodoro para sanitarios modelo Tesi realizado en DM pintado epoxi y bisagras de latón cromado

Сиденье для унитаза модели Tesi, туалетное сиденье из МДФ покрытие эпоксидным лаком и хромированные латунные петли



L35 x P45 x H5,7 cm

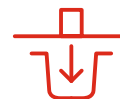

Fissaggio a espansione dall'alto

Top fast fix



02

Bianco  
White



Fissaggio a espansione dall'alto

Top fast fix



02

Bianco  
White



L35 x P46,5 x H5,9 cm

## 4014.

GEDY

Sedile WC per sanitari modello Ellisse, realizzato in MDF con laccatura epossidica e cerniere in ottone cromato

Toilet seat for Ellisse sanitary fixtures made of epoxy lacquered M.D. with chromed brass hinges

Abattant pour sanitaires modèle Ellisse réalisé en M.D. avec laquage époxy et fixations en laiton chromé

WC-Sitz für Modell Ellisse, Hergestellt aus M.D. mit Epoxid-Beschichtung mit Befestigungen aus verchromtem Messing

Asiento de inodoro para sanitarios modelo Ellisse realizado en DM pintado epoxi y bisagras de latón cromado

Сиденье для унитаза модели Ellisse, туалетное сиденье из МДФ покрытие эпоксидным лаком и хромированные латунные петли



Fissaggio a espansione dall'alto

Top fast fix



02

Bianco  
White



L36 x P47 x H5,5 cm

## 4024.

GEDY

Sedile WC per sanitari modello Aretusa, realizzato in MDF con laccatura epossidica e cerniere in ottone cromato

Toilet seat for Aretusa sanitary fixtures made of epoxy lacquered M.D. with chromed brass hinges

Abattant pour sanitaires modèle Aretusa réalisé en M.D. avec laquage époxy et fixations en laiton chromé

WC-Sitz für Modell Aretusa, Hergestellt aus M.D. mit Epoxid-Beschichtung mit Befestigungen aus verchromtem Messing

Asiento de inodoro para sanitarios modelo Aretusa realizado en DM pintado epoxi y bisagras de latón cromado

Сиденье для унитаза модели Aretusa, туалетное сиденье из МДФ покрытие эпоксидным лаком и хромированные латунные петли



Fissaggio a espansione dall'alto

Top fast fix



02

Bianco  
White



L35 x P48 x H5,8 cm

## 4027.

GEDY

Sedile WC per sanitari modello Sintesi, realizzato in MDF con laccatura epossidica e cerniere in ottone cromato

Toilet seat for Sintesi sanitary fixtures made of epoxy lacquered M.D. with chromed brass hinges

Abattant pour sanitaires modèle Sintesi réalisé en M.D. avec laquage époxy et fixations en laiton chromé

WC-Sitz für Modell Sintesi, Hergestellt aus M.D. mit Epoxid-Beschichtung mit Befestigungen aus verchromtem Messing

Asiento de inodoro para sanitarios modelo Sintesi realizado en DM pintado epoxi y bisagras de latón cromado

Сиденье для унитаза модели Sintesi, туалетное сиденье из МДФ покрытие эпоксидным лаком и хромированные латунные петли



**Fissaggio a espansione dall'alto**

**Top fast fix**



02  
**Bianco**  
White



L36 x P41,5 x H6 cm

**4028.**

**GEDY**

Sedile WC per sanitari modello Victoria, realizzato in MDF con laccatura epossidica e cerniere in ottone cromato  
Toilet seat for Victoria sanitary fixtures made of epoxy lacquered M.D. with chromed brass hinges  
Abattant pour sanitaires modèle Victoria réalisé en M.D. avec laquage époxy et fixations en laiton chromé  
WC-Sitz für Modell Victoria, Hergestellt aus M.D. mit Epoxid-Beschichtung mit Befestigungen aus verchromtem Messing  
Asiento de inodoro para sanitarios modelo Victoria realizado en DM pintado epoxi y bisagras de latón cromado  
Сиденье для унитаза модели Victoria, туалетное сиденье из МДФ покрытие эпоксидным лаком и хромированные латунные петли



**Fissaggio a espansione dall'alto**

**Top fast fix**



02  
**Bianco**  
White



L34,4 x P44,7 x H6 cm

**4030.**

**GEDY**

Sedile WC per sanitari modello System, realizzato in MDF con laccatura epossidica e cerniere in ottone cromato  
Toilet seat for System sanitary fixtures made of epoxy lacquered M.D. with chromed brass hinges  
Abattant pour sanitaires modèle System réalisé en M.D. avec laquage époxy et fixations en laiton chromé  
WC-Sitz für Modell System, Hergestellt aus M.D. mit Epoxid-Beschichtung mit Befestigungen aus verchromtem Messing  
Asiento de inodoro para sanitarios modelo System realizado en DM pintado epoxi y bisagras de latón cromado  
Сиденье для унитаза модели System, туалетное сиденье из МДФ покрытие эпоксидным лаком и хромированные латунные петли



**Decoro metallico**  
**Decorative metal plate**



**Universale**  
**Universal**



L37,5 x P44,5 x H6 cm



02  
**Open**



06  
**Gas**

**C042 Onice.**

**GEDY**

Realizzato in MDF con laccatura epossidica e decoro metallico, dotato di cerniere in ottone cromato  
Made of epoxy lacquered M.D with decorative metal plate, chromed brass hinges  
Réalisé en M.D. avec laquage époxy et plaque de métal, fixations en laiton chromé  
Hergestellt aus M.D. mit Epoxid-Beschichtung mit Metall-Dekor, mit Befestigungen aus verchromtem Messing  
Realizado en DM pintado epoxi con placa metálica, bisagras de latón cromado  
Изготовлено из МДФ с металлической пластиной, покрытие эпоксидным лаком и петли из хромированной латуни

**4017 Diamante.**

**GEDY**

Realizzato in resine termoindurenti, dotato di cerniere in resine termoplastiche  
Made of thermosetting resins with adjustable plastic hinges  
Réalisé en thermodurcissable avec fixations réglables en thermoplastique  
Hergestellt aus Duroplast mit Befestigungen aus Kunststoff  
Realizado en resinas termoestables con bisagras de resinas termoestables  
Изготовлено из термореактивных пластмасс.  
Петли из термопластичных смол



**Universale**  
**Universal**



02  
**Bianco**  
White



L37,3 x P45,7 x H5,7 cm

## 4001 Ametista.

GEDY

Realizzato in resine termoindurenti con cerniere in acciaio inox

Made of thermosetting resins, hinges of stainless steel

Réalisé en thermodurcissable, fixations en acier inoxydable

Hergestellt aus Duroplast mit Scharniere aus Edelstahl

Realizado en resinas termoestables con bisagras de acero inoxidable

Изготовлено из термореактивных пластмасс с петлями из нержавеющей стали



L37,8 x P45,7 x H5 cm



Soft close  
Soft close



Sgancio facile  
Easy detach



Igiene facile  
Easy clean



Universale  
Universal



02  
Bianco  
White

## 4004 Topazio.

GEDY

NEW

Realizzato in resine termoindurenti con cerniere in acciaio inox e nylon

Made of thermosetting resins, hinges of stainless steel and nylon

Réalisé en thermodurcissable, fixations en acier inoxydable et nylon

Hergestellt aus Duroplast mit Scharniere aus Edelstahl und Nylon

Realizado en resinas termoestables con bisagras de acero inoxidable y nailon

Изготовлено из термореактивных пластмасс с петлями из нержавеющей стали и нейлон



Universale  
Universal



Soft close  
Soft close



Sgancio facile  
Easy detach



Igiene facile  
Easy clean



Fissaggio a  
espansione dall'alto  
Top fast fix



02  
Bianco  
White



con Antibatterico  
with Antibacterial



Fissaggio  
veloce  
Fast fix

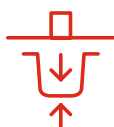

Doppio fissaggio  
ALTO - BASSO  
Double fix  
TOP - BOTTOM



36,3 x 43,6 x 4,5 cm



Universale  
Universal



02  
Bianco  
White



L37,2 x P45,8 x H5,4 cm

## 4003 Zircono.

GEDY

Realizzato in resine termoindurenti con cerniere in acciaio inox  
 Made of thermosetting resins, hinges of stainless steel  
 Réalisé en thermodurcissable, fixations en acier inoxydable  
 Hergestellt aus Duroplast mit Scharniere aus Edelstahl  
 Realizado en resinas termoestables con bisagras de acero inoxidable  
 Изготовлено из термореактивных пластмасс с петлями из нержавеющей стали

## 4031 Madreperla.

GEDY

Realizzato in polipropilene con cerniere in polipropilene  
 Made of polypropylene with polypropylene hinges  
 Réalisé en polypropylène avec fixations en polypropylène  
 Hergestellt aus Polypropylen mit Befestigungen aus Polypropylen  
 Realizado en polipropileno con bisagras de polipropileno  
 Изготовлено из Полипропиленовые на петли Полипропиленовые



02  
Bianco  
White



L36,3 x P45 x H5,2 cm



Universale  
Universal



Soft close  
Soft close



Fissaggio a  
espansione dall'alto  
Top fast fix



02  
Bianco  
White

100% MADE  
in Italy



L37 x P45,5 x H4,5 cm

## 4019 Oscar.

GEDY

Realizzato in polipropilene con cerniere in polipropilene  
 Made of polypropylene with polypropylene hinges  
 Réalisé en polypropylène avec fixations en polypropylène  
 Hergestellt aus polypropylène mit Befestigungen aus Polypropylen  
 Realizado en polipropileno con bisagras de polipropileno  
 Изготовлено из Полипропиленовые на петли Полипропиленовые



Universale  
Universal

## 4008 Ambra.

GEDY

Realizzato in resine termoplastiche con cerniere in polietilene  
 Made of thermoplastic resin with polythene hinges  
 Réalisé en thermoplastique avec fixations en polythène  
 Hergestellt aus Kunststoff mit Befestigungen aus Polyäthylen  
 Realizado en resinas termoplásticas con bisagras de politeno  
 Изготовлено из термопластичных смол на петли полиэтилен



Universale  
Universal



02  
Bianco  
White



L37,5 x P46,5 x H3 cm

100% MADE  
in Italy





COMPLEMENTI  
D'ARREDO

Furnishing accessories







## Piantane

Towel stands - Porte serviettes - Handtuchständer  
Toalleros de pie - Стойка для полотенец



**7631**

H92 cm

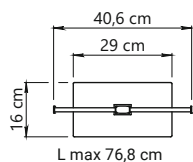

**7632**

H69 cm

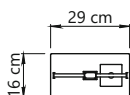

## Bridge.

TOP DESIGN

### Acciaio inox, Cromall® e ottone

Stainless steel, Cromall® and brass

Acier inoxydable, Cromall® et laiton

Edelstahl, Cromall® und Messing

Acero inox, Cromall® y latón

Нержавеющей стали, Cromall® и латунные



13  
Cromato  
Chromed



GARANZIA  
WARRANTY



# Florida.

RETAIL

## Acciaio inox, Cromall® e resine termoplastiche

Stainless steel, Cromall® and thermoplastic resins

Acier inoxydable, Cromall® et résine thermoplastique

Edelstahl, Cromall® und Kunststoff

Acero inox, Cromall® y resinas termoplásticas

нержавеющая сталь, Cromall® и термопластичные смолы



13  
Cromato  
Chromed



14  
Nero matt  
Matt black



GARANZIA  
WARRANTY



**7331**

H89,9 cm

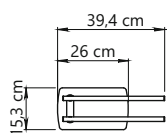

**7332**

H64,4 cm

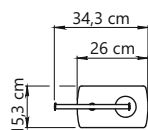

**Artù.**

RETAIL

**Acciaio inox e Cromall®**

Stainless steel and Cromall®

Acier inoxydable et Cromall®

Edelstahl und Cromall®

Acero inox y Cromall®

Нержавеющей стали и Cromall®



13  
Cromato  
Chromed



14  
Nero matt  
Matt black



GARANZIA  
WARRANTY



**1131**  
H83,6 cm

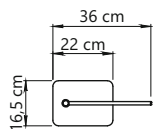

**1132**  
H66,7 cm

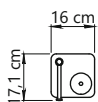

**Artù.**



03

**Cromato/Beige**  
Chromed/Beige



**GARANZIA**  
**WARRANTY**

**Acciaio inox, Cromall®, resina e sabbia**

Stainless steel, Cromall®, resin and sand

Acier inoxydable, Cromall®, résine et sable

Edelstahl, Cromall®, Harz und Sand

Acero inox, Cromall®, resina y arena

Нержавеющей стали, Cromall®, смол и песчаника

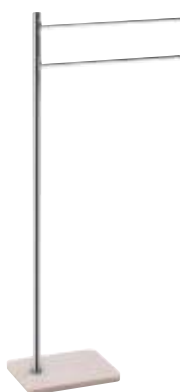

**1131**

H84,9 cm

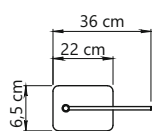

**1132**

H67,8 cm

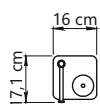

# Maine.

GEDY

## Acciaio inox, Cromall® e resine termoplastiche

Stainless steel, Cromall® and thermoplastic resins

Acier inoxydable, Cromall® et thermoplastique

Edelstahl, Cromall® und Kunststoff

Acero inox, Cromall® y resinas termoplásticas

нержавеющая сталь, Cromall® и термопластичные смолы



13  
Cromato  
Chromed



GARANZIA  
WARRANTY



7831

H89,4 cm

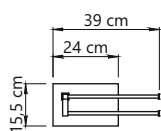

7832

H69,7 cm

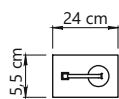

# Tobia.

GEDY

## Acciaio inox e resine termoplastiche

Stainless steel and thermoplastic resins

Acier inoxydable et thermoplastique

Edelstahl und Kunststoff

Acero inox y resinas termoplásticas

нержавеющая сталь и термопластичные смолы



13  
Cromato  
Chromed



GARANZIA  
WARRANTY



7131

H89 cm

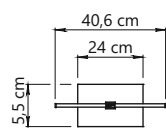

7132

H75 cm

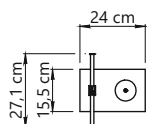



# Virginia.

GEDY

## Acciaio inox e resine termoplastiche

Stainless steel and thermoplastic resins

Acier inoxydable et thermoplastique

Edelstahl und Kunststoff

Acero inox y resinas termoplásticas

нержавеющая сталь и термопластичные смолы



13  
Cromato  
Chromed



GARANZIA  
WARRANTY



2131

H87 cm

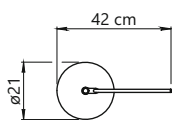

2132

H61 cm

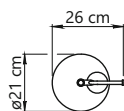

**Felix.**

**NEW**

**GEDY**



13  
**Cromato**  
Chromed



**GARANZIA**  
**WARRANTY**

**Acciaio inox, metallo e resine termoplastiche**

Stainless steel, metal and thermoplastic resins

Acier inoxydable, métal et thermoplastique

Edelstahl, Metall und Kunststoff

Acero inox, metal y resinas termoplásticas

Нержавеющая сталь, металла и термопластичные смолы



**1331**

H77,8 cm

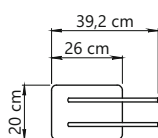

**1332**

H69,8 cm

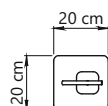

# Tracy.

GEDY



13  
Cromato  
Chromed

## Metallo con contenitore in vetro satinato

Metal with frosted glass container

Métal avec boîtier en verre satiné

Metall mit Behälter aus satiniertem Glas

Metal con contenedore en cristal satinado

Металла с ёмкостями из матового стекла



**2731**

H94,3 cm

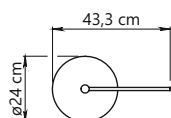

**2732**

H77,5 cm

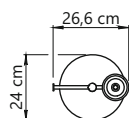



**Circe.**

**NEW**

**GEDY**



13  
**Cromato**  
Chromed



**GARANZIA**  
**WARRANTY**

**Acciaio inox, metallo e resine termoplastiche**

Stainless steel, metal and thermoplastic resins

Acier inoxydable, métal et thermoplastique

Edelstahl, Metall und Kunststoff

Acero inox, metal y resinas termoplásticas

нержавеющая сталь, металла и термопластичные смолы



**1431**

H79,8 cm

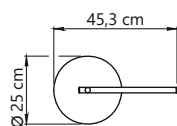

**1432**

H61,7 cm

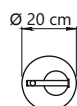

# Rainbow.

GEDY

## Acciaio inox e resine termoplastiche

Stainless steel and thermoplastic resins

Acier inoxydable et thermoplastique

Edelstahl und Kunststoff

Acero inox y resinas termoplásticas

нержавеющая сталь и термопластичные смолы

Colori trasparenti - Transparent colours:



02  
**Bianco**  
White



04  
**Verde acido**  
Acid green



05  
**Blu**  
Blue



06  
**Rosso**  
Red



14  
**Nero**  
Black



52  
**Tortora**  
Turtledove  
grey

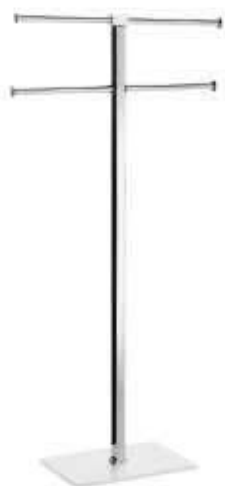

**RA31**

H83,9 cm

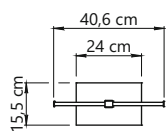

Piantane - Towel stands .

Colori pieni - Solid colours:

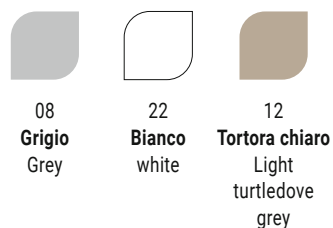

**GARANZIA  
WARRANTY**



**RA32**

H58,8 cm

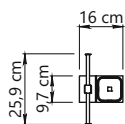

# Winny.

GEDY

design Piet Billekens

**Acciaio inox**

Stainless steel

Acier inoxydable

Edelstahl

Acero inox

Нержавеющей стали



02  
**Bianco**  
White



13  
**Cromato**  
Chromed



**GARANZIA**  
**WARRANTY**

**2831**

H90 cm

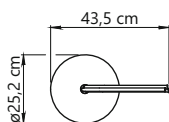

**2832**

H76,7 cm

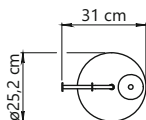















































































































































































































































































































































## Easy.

GEDY



Lucido  
Polished



**EASY 06 - GYSS10006**

24,5 x 11,8 x 60,5



4 Jets



Rain



Massage



Soft



Tonic



Lucido  
Polished



**EASY 05 - GYSS10005**

14,5 x 13,8 x 60,5



1 Jet



Rain



**EASY 02 - GYSS10002**

13,7 x 18,1 x 60,5

## Liberty.

GEDY



1 Jet



Rain



Cromato  
Chromed



**LIBERTY 00 - GYSS10600**

9,5 x 30,5 x 74,5 cm



Bronzo  
Bronze



**LIBERTY 01 - GYSS10601**

9,5 x 30,5 x 74,5 cm



Rame  
Copper



**LIBERTY 02 - GYSS10602**

9,5 x 30,5 x 74,5 cm

# Tendence.

GEDY



**Cromato/Bianco**  
Chromed/White



1 Jet



Rain



**Cromato/Nero matt**  
Chromed/Matt black



**TENDENCE 06 - GYSS10506**

17,6 x 19 x 81 cm



**TENDENCE 07 - GYSS10507**

17,6 x 19 x 81 cm



GARANZIA  
WARRANTY

## Colonne doccia Shower columns

**Una gamma compatta che va incontro a tutti i gusti e alle funzioni richieste nella doccia, racchiuse in un solo articolo compatto e dalle giuste proporzioni.**

**Tutte le colonne sono regolabili in altezza per il massimo confort nella doccia per tutti i membri della famiglia.**

A compact range to satisfy all tastes and all of the functions required of a shower, in a single, compact and perfectly sized item. All columns are height adjustable for maximum shower comfort for all members of the family.

Une gamme compacte qui satisfait tous les goûts et les fonctions d'une douche, réunies en un seul article compact et bien proportionné. Toutes les colonnes sont réglables en hauteur assurant le plus grand confort à l'intérieur de la douche à tous les membres de la famille.

Eine kompakte, trendige Produktpalette, die alle Funktionen einer Dusche erfüllt, und dies in einem einzigen kompakten Artikel mit den richtigen Proportionen. Alle Duschsäulen sind höhenverstellbar, um allen Mitgliedern der Familie in der Dusche den optimalen Komfort zu bieten.

Una gama compacta que satisface todos los gustos y las funciones requeridas para la ducha, unidas en un sólo artículo compacto y de proporciones adecuadas. Todas las barras para la ducha son regulables en altura para el máximo confort en la ducha de todos los miembros de la familia.

Эта компактная линейка душей отвечает всем требованиям и вкусам, объединенными в одном предмете оптимальных размеров. Все души-колонны регулируются по высоте, что обеспечивает максимальный комфорт в душе для всех членов семьи.



**Risparmio idrico**  
Water saving



**Universale**  
Standard



**Filtro Antisabbia**  
Sand filter



**Pulizia facile**  
Easy clean



**Anticalcare**  
Anti-limestone

**Realizzati in ABS e acciaio inox**  
Made of ABS and stainless steel  
Réalisés en ABS and acier inoxydable  
Hergestellt aus ABS und Edelstahl  
Realizados en ABS y acero inox  
Изготовлено из АБС и нержавеющей стали



**Universale**  
Standard



**Doppia aggraffatura**  
Double Lock



**Antitorsione**  
Anti-Twist



**Resistente alle piegature**  
Anti-Fold



**Resistente**  
Resistente

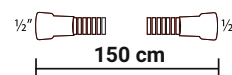
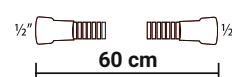

Per assistenza tecnica prendere visione della sezione RETE VENDITA nel nostro sito [www.gedy.com](http://www.gedy.com)  
For technical assistance, read the SALES NETWORK section on our website [www.gedy.com](http://www.gedy.com)

# Star Mix.

GEDY



**Cromato**  
Chromed



**Nero matt**  
Matt black



**STAR MIX 01 - GYSC10301**

26 x 55 x 98,5/133,5 cm

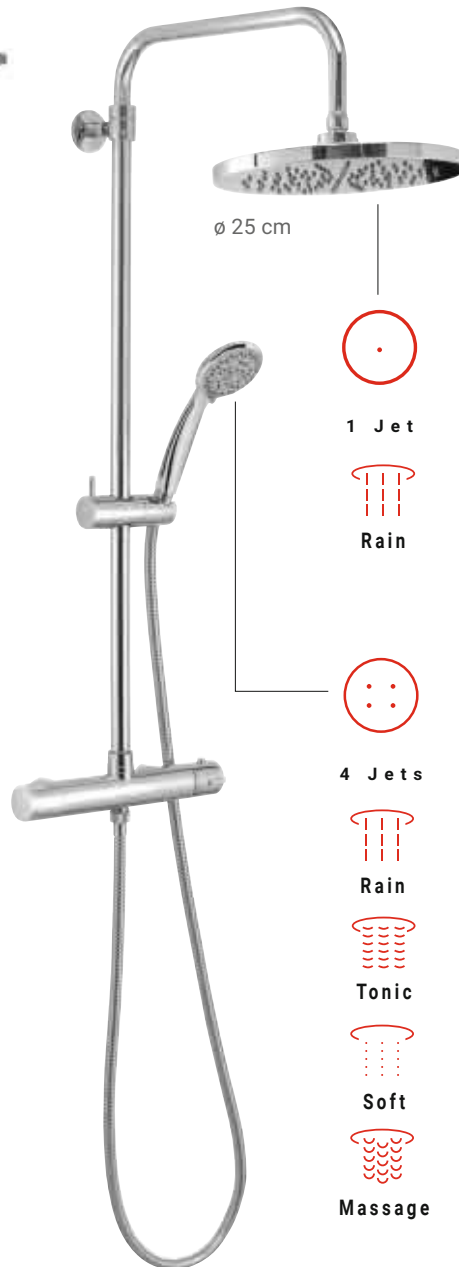

**STAR MIX 00 - GYSC10300**

27,5 x 50,5 x 84,5/125,5 cm



**STAR MIX 03 - GYSC10303**

28 x 49,3 x 83/127 cm

**Easy.**

GEDY



**Cromato**  
Chromed

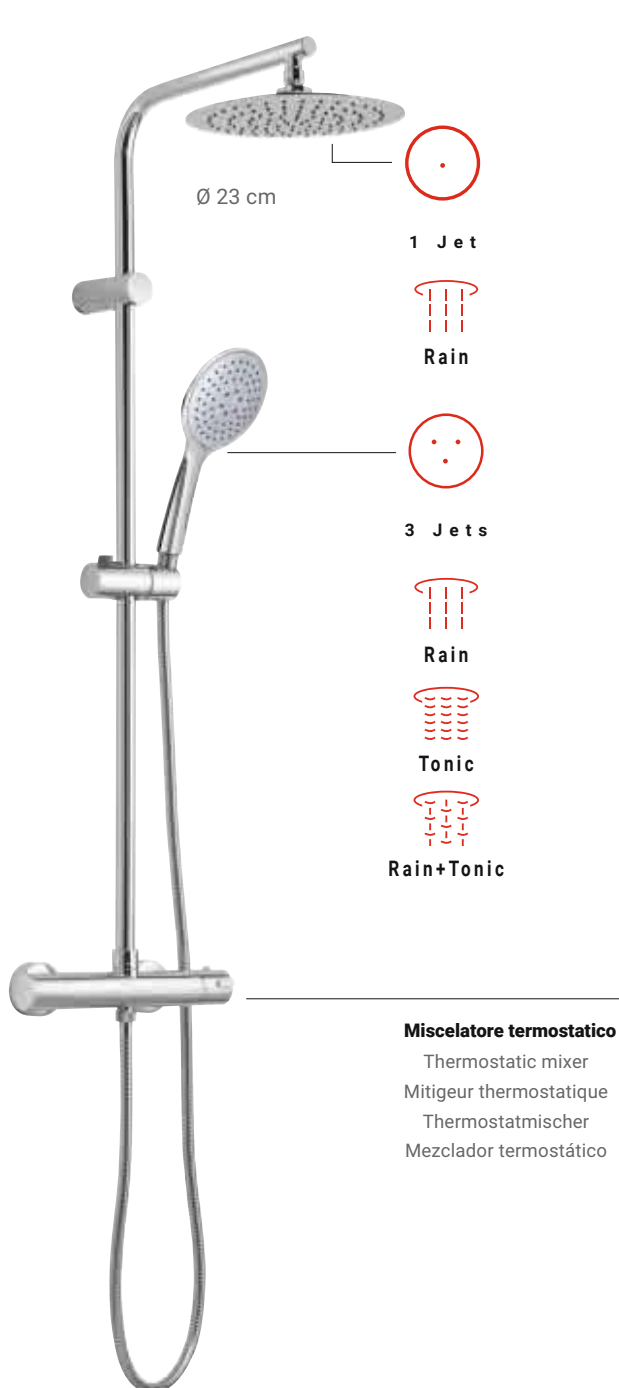

**EASY MIX 02 - GYSC10102**

27,5 x 46,5 x 102 cm

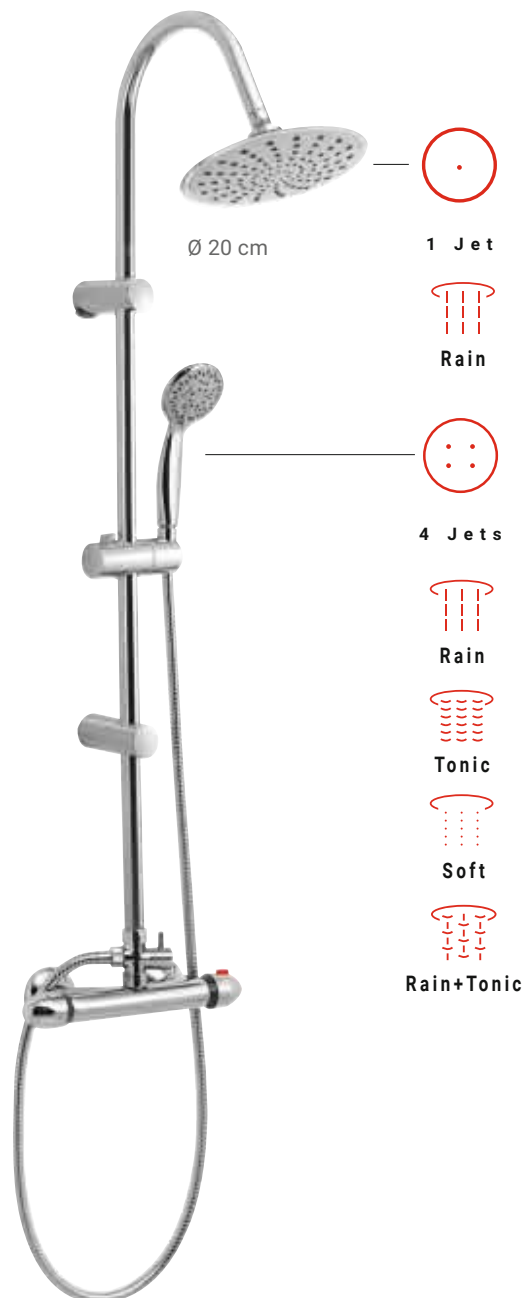

**EASY MIX 01 - GYSC10101**

29 x 40,5 x 108,5 cm

# Star Plus.

GEDY



**Cromato**  
Chromed



**Nero matt**  
Matt black

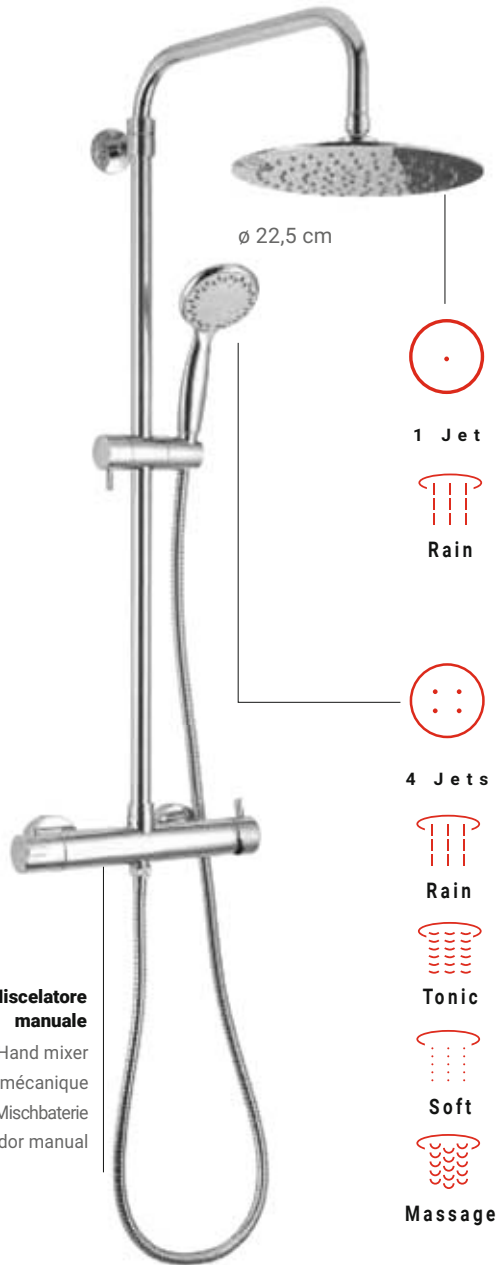

**Miscelatore manuale**

Hand mixer  
Mitigeur mécanique  
Manuelle Mischbatterie  
Mezclador manual

**STAR PLUS 00 - GYSC10250**

20 x 55 x 80/140 cm



**Miscelatore manuale**

Hand mixer  
Mitigeur mécanique  
Manuelle Mischbatterie  
Mezclador manual

**STAR PLUS 01 - GYSC10251**

28,8 x 49 x 84/144 cm

## Tech.

GEDY



Cromato  
Chromed



**TECH 00 - GYSC10400**

23 x 49 x 109 cm

## Star.

GEDY



Cromato  
Chromed



**STAR 02 - GYSC10202**

20 x 46 x 70 cm



**STAR 01 - GYSC10201**

20 x 49 x 106 cm



**STAR 00 - GYSC10200**

25 x 50,5 x 82,5 cm



Easy.

GEDY



Cromato  
Chromed



**EASY 05 - GYSC10005**

20 x 41 x 100 cm

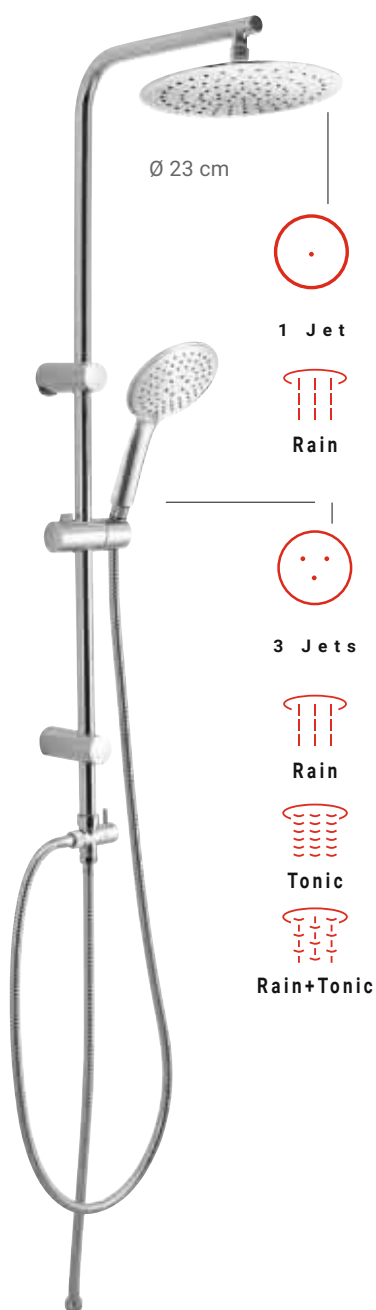

**EASY 04 - GYSC10004**

23 x 46 x 100 cm

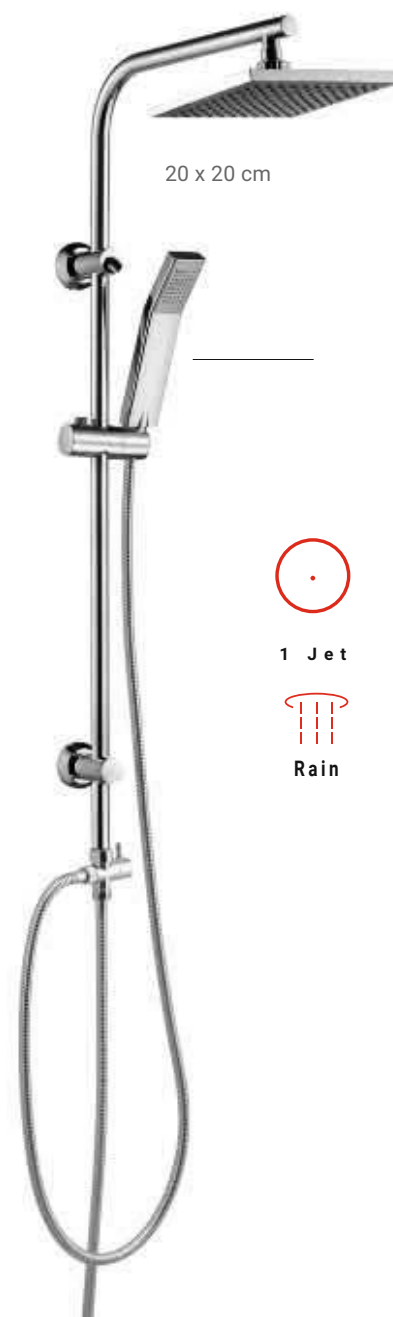

**EASY 03 - GYSC10003**

20 x 44,5 x 100 cm

IDROTERAPIA . HYDROTHERAPY .



**Cromato**  
Chromed



**Cromato/Bianco**  
Chromed/White



**Cromato**  
Chromed

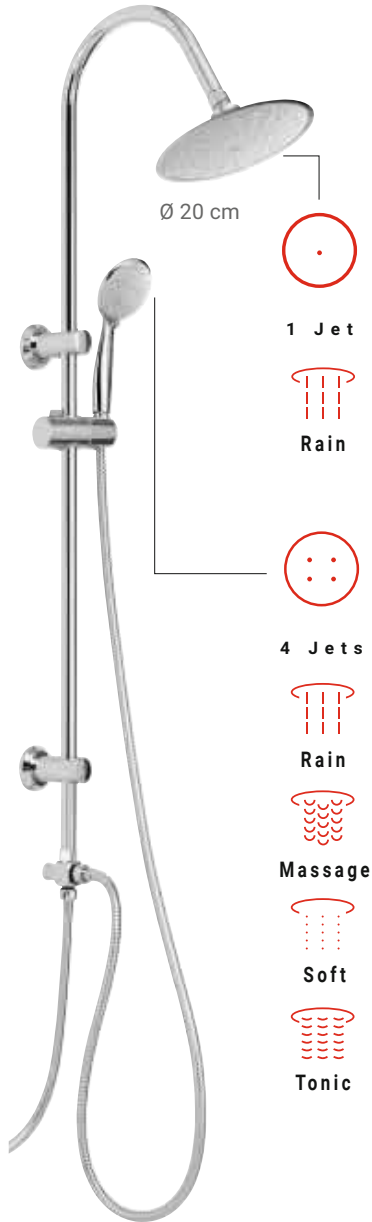

**EASY 02 - GYSC10002**

20 x 39 x 104 cm

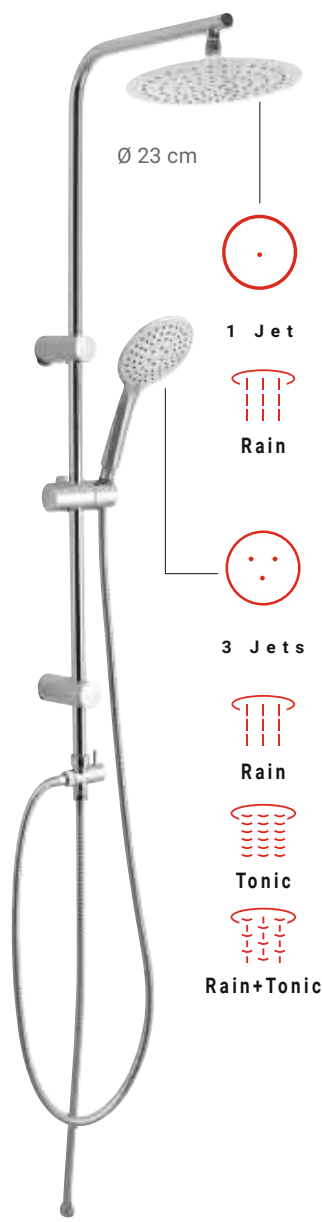

**EASY 01 - GYSC10001**

23 x 46 x 100 cm



**EASY 00 - GYSC10000**

20 x 40,5 x 104 cm

## Music.

GEDY



1 Jet



Rain



Bluetooth



Cromato/Bianco  
Chromed/White



MUSIC 00 - GYSC10900

23 x 51 x 91 cm

## Light.

GEDY



Cromato  
Chromed



Color  
change



1 Jet



Rain



3 Jets



Rain



Tonic



Rain+Tonic

LIGHT 00 - GYSC10800

20 x 45 x 100 cm



# Liberty.

GEDY



1 Jet



Rain



**Cromato**  
Chromed



**LIBERTY 00 - GYSC10600**

20 x 43 x 105 cm



**Bronzo**  
Bronze



**LIBERTY 01 - GYSC10601**

20 x 43 x 105 cm



**Rame**  
Copper



**LIBERTY 02 - GYSC10602**

20 x 43 x 105 cm



GARANZIA  
WARRANTY

## Pannelli doccia Shower panels

**A lato dei moderni pannelli in acciaio inox in finitura spazzolata, GEDY presenta anche una collezione di pannelli doccia multifunzione in vetro temperato ultralight laccato in colorazioni abbinabili con la sua enorme gamma di accessori e complementi per il bagno.**

Alongside the modern panels in stainless steel with brushed finish, GEDY also has a collection of multipurpose shower panels in ultralight tempered glass, which combine with its enormous range of accessories and complementary features for the bathroom.

Outre les panneaux modernes en acier inox dans la finition brossée, GEDY présente une collection de panneaux de douche multifonction en verre trempé ultralight laqué dans des couleurs à assortir à sa gamme considérable d'accessoires et d'éléments de décoration pour la salle de bains.

Neben den moderne Paneelen aus gebürstetem Edelstahl bietet GEDY auch eine Kollektion von Multifunktionsduschpaneelen aus utraleichem gehärtetem Glas an, lackiert in Farben, die mit der enormen Palette der Accessoires für das Bad kombiniert werden kann.

Además de los modernos paneles de acero inoxidable con acabado cepillado, GEDY presenta también una colección de paneles ducha multifunción de vidrio templado ultralight laqueado en colores combinables con su enorme gama de accesorios y complementos para el baño.

Наряду с душевыми панелями из нержавеющей стали с отделкой «эффект щетки» GEDY представляет также коллекцию душевых многофункциональных панелей из суперлегкого закаленного стекла, покрытого цветным лаком, который можно сочетать с множеством аксессуаров и дополнений для ванной.



Risparmio idrico  
Water saving



Universale  
Standard



Filtro Antisabbia  
Sand filter



Pulizia facile  
Easy clean



Anticalcare  
Anti-limestone



Universale  
Standard



Doppia aggraffatura  
Double Lock



Antitorsione  
Anti-Twist



Resistente  
alle piegature  
Anti-Fold



Resistent  
Resistente

### Realizzati in ABS, acciaio inox e ottone

Made of ABS, stainless steel and brass - Réalisés en ABS, acier inoxydable and laiton

Hergestellt aus ABS, Edelstahl und Messing - Realizados en ABS, acero inox y latón

Изготовлено из АБС, нержавеющей стали и латунь

Per assistenza tecnica prendere visione della sezione RETE VENDITA nel nostro sito [www.gedy.com](http://www.gedy.com)  
For technical assistance, read the SALES NETWORK section on our website [www.gedy.com](http://www.gedy.com)

# Spa.

GEDY

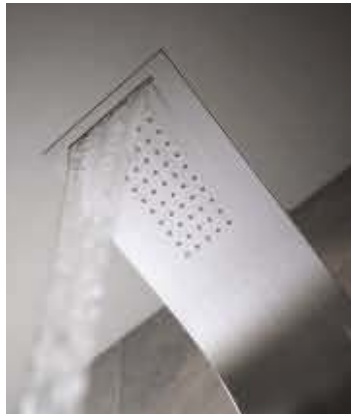

Bianco  
White

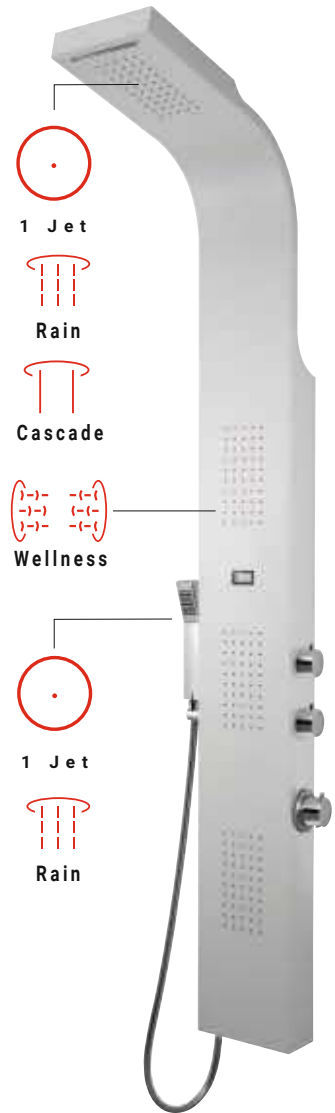

**SPA 00 - GYSP10600**

29 x 47 x 166 cm

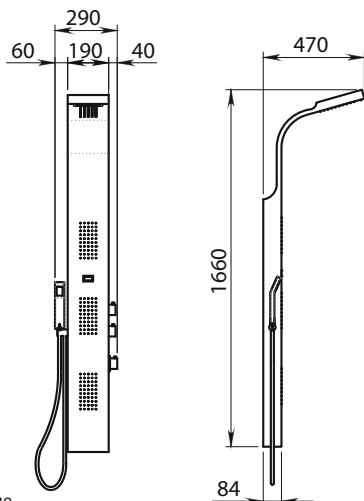

Nero  
Black

**SPA 01 - GYSP10601**

29 x 47 x 166 cm



Inox spazzolato  
Brushed stainless  
steel

**SPA 02 - GYSP10602**

29 x 47 x 166 cm

**Miscelatore termostatico**

Thermostatic mixer  
Mitigeur thermostatique  
Thermostatmischer  
Mezclador termostático  
Термостатический  
смеситель



# Wellness.

GEDY



Nero  
Black

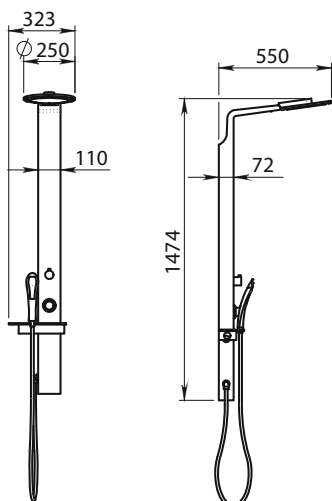
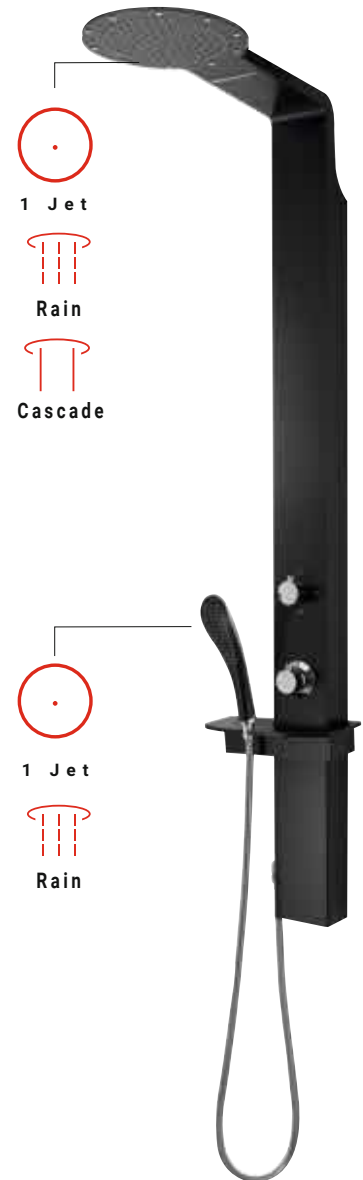

Bianco  
White



Inox spazzolato  
Brushed stainless  
steel

## WELLNESS 01 - GYSP10501

32,3 x 55 x 147,4 cm

## WELLNESS 02 - GYSP10502

32,3 x 55 x 147,4 cm

## WELLNESS 00 - GYSP10500

32,3 x 55 x 147,4 cm

### Miscelatore termostatico

Thermostatic mixer  
Mitigeur thermostatique  
Thermostatmischer  
Mezclador termostático  
Термостатический  
смеситель

# Massage.

GEDY



**Inox spazzolato**  
Brushed  
stainless steel

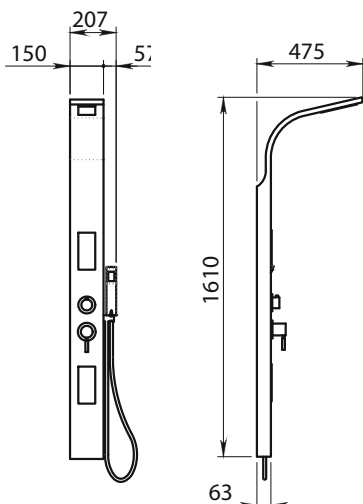
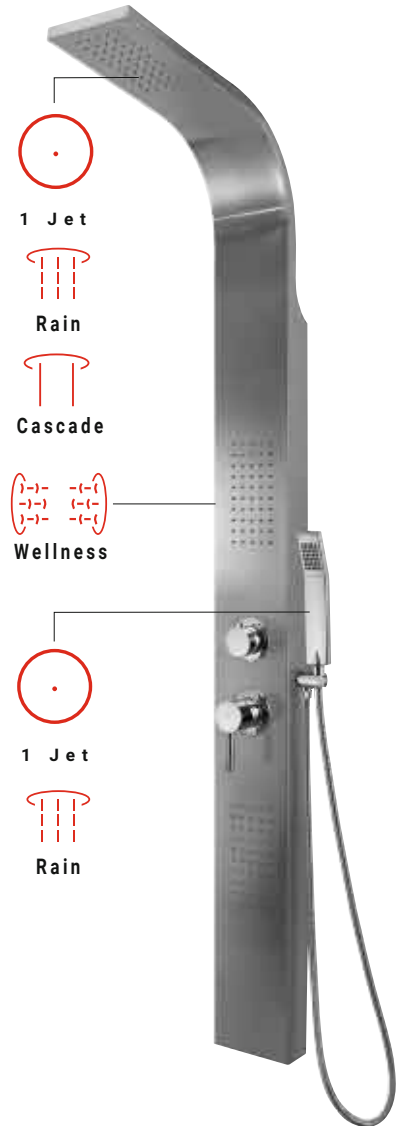

**MESSAGE 01 - GYSP10401**

20,7 x 47,5 x 161 cm

**Miscelatore manuale**

Manual mixer  
Mitigeur manuel  
Manueller Mischer  
Mezclador manual  
Ручной миксер



# Cascade. Cascade Plus.

GEDY



**Inox spazzolato**  
Brushed  
stainless steel



1 Jet



Rain



Cascade

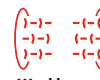

Wellness



1 Jet



Rain

**Miscelatore manuale**

Manual mixer  
Mitigeur manuel  
Manueller Mischer  
Mezclador manual  
Ручной миксер

**CASCADE 00 - GYSP10200**

18 x 50,5 x 154 cm

**CASCADE PLUS 00 - GYSP10300**

18 x 50,5 x 154 cm

**Miscelatore termostatico**

Thermostatic mixer  
Mitigeur thermostatique  
Thermostatmischer  
Mezclador termostático  
Термостатический  
смеситель

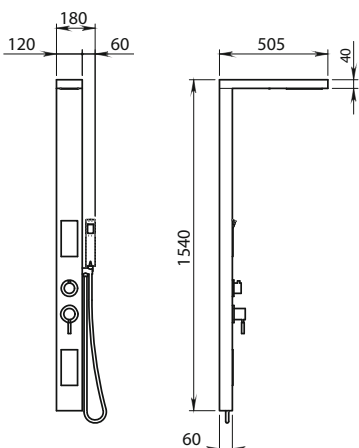

# Style.

GEDY



**Argento**  
Silver

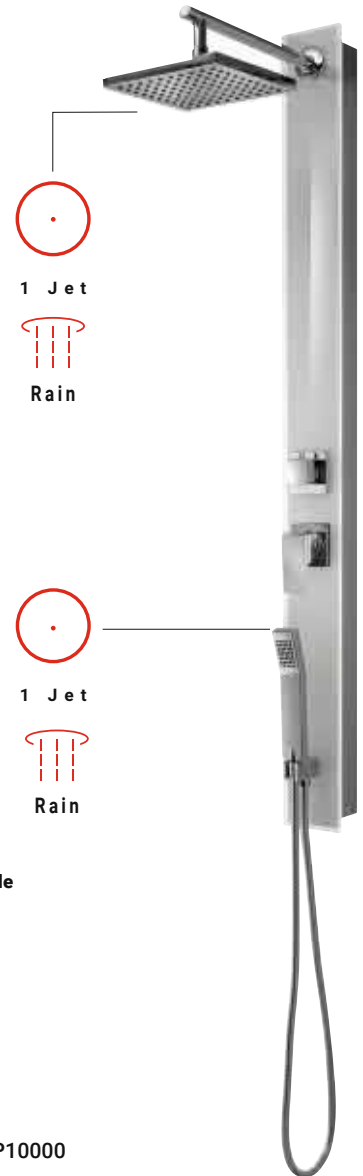

**Miscelatore manuale**

Manual mixer  
Mitigeur manuel  
Manueller Mischer  
Mezclador manual  
Ручной миксер

**STYLE 00 - GYSP10000**

20,3 x 47,9 x 130,2 cm

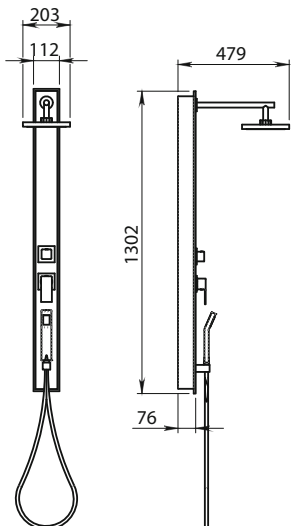

**Bianco**  
White

**STYLE 01 - GYSP10001**

20,3 x 47,9 x 130,2 cm

**Vetro temperato**

Tempered glass  
Verre tempéré  
Sekuritglas  
Cristal templado  
закаленное стекло



GARANZIA  
WARRANTY

## Soffioni Shower heads

**Largo ventaglio di misure, funzioni, forme e materiali per i soffioni doccia GEDY, tutti dotati di filtro antisabbia, tecnologia water saving, tettarelle che permettono una rapida rimozione manuale del calcare.**

Wide range of size, functions, shapes and materials for GEDY shower heads, all with sand filter, water saving technology and nipples for easy scale removal by hand.

Vaste gamme de dimensions, de fonctions, de formes et de matériaux pour les pommes de douche GEDY, toutes munies d'un filtre anti-sable, suivant la technologie water saving, des picots qui permettent une élimination manuelle rapide du calcaire.

Neben den moderne Paneelen aus gebürstetem Edelstahl bietet GEDY auch eine Kollektion von Multifunktionsduschpaneelen aus utraleichem gehärtetem Glas an, lackiert in Farben, die mit der enormen Palette der Accessoires für das Bad kombiniert werden kann.

Große Vielfalt von Größen, Funktionen, Formen und Materialien für die Duschstrahler GEDY, alle ausgestattet mit Sandfilter, Water-Saving-Technologie und Einsatz für die schnelle Entfernung von Kalkablagerungen.

Ассортимент леек GEDY представлен богатым выбором размеров, функций, форм и материалов. Все они оснащены фильтром для задержки песка, регулятором расхода воды и легко чистящимися от скопившейся накипи соплами.



Risparmio idrico  
Water saving



Universale  
Standard



Filtro Antisabbia  
Sand filter



Pulizia facile  
Easy clean

# Design.

TOP DESIGN

design Simone Micheli



Bianco  
White



1 Jet



Rain



DESIGN 01 - GYSH10501

Ø 50 x 1,5 cm

Realizzato in acciaio inox AISI 304

Made of stainless steel 304 AISI

Réalisé en acier inox 304 AISI

Hergestellt aus Rostfreier Stahl 304 AISI

Realizado en acero inoxidable 304 AISI

Изготовлено из нержавеющей сталь 304 AISI

AISI  
304

# Top.

GEDY



1 Jet



Rain



Maggiore  
pressione  
del getto

Stronger jet  
spray



Cromato  
Chromed

Realizzato in ABS

Made of ABS

Réalisé en ABS

Hergestellt aus ABS

Realizado en ABS

Изготовлено из АБС



TOP 01 - GYSH10401

Ø 22,5 x 6 cm

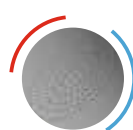

Microfori  
Microholes



TOP 00 - GYSH10400

Ø 11 x 7,5 cm

**Tech.**

GEDY



1 Jet



Rain



Lucido  
Polished



**Realizzati in acciaio inox AISI 304 e ottone**

Made of stainless steel 304 AISI and brass

Réalisé en acier inox 304 AISI et laiton

Hergestellt aus Rostfreier Stahl 304 AISI und Messing

Realizado en acero inoxidable 304 AISI y latón

Изготовлено из нержавеющей сталь 304 AISI и латунь



**TECH 10 - GYSH10310**

10 x 10 x 5 cm



**TECH 11 - GYSH10311**

Ø 10 x 5 cm

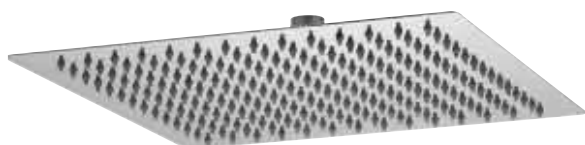

**TECH 09 - GYSH10309**

50 x 50 x 5 cm

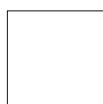

**TECH 07 - GYSH10307**

40 x 40 x 5 cm



**TECH 01 - GYSH10301**

30 x 30 x 5 cm



**TECH 05 - GYSH10305**

25 x 25 x 5 cm



**TECH 03 - GYSH10303**

20 x 20 x 5 cm



**TECH 08 - GYSH10308**

Ø 50 x 5 cm

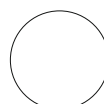

**TECH 06 - GYSH10306**

Ø 40 x 5 cm



**TECH 00 - GYSH10300**

Ø 30 x 5 cm



**TECH 04 - GYSH10304**

Ø 25 x 5 cm



**TECH 02 - GYSH10302**

Ø 20 x 5 cm



IDROTERAPIA . HYDROTHERAPY .

**Star.**

GEDY



1 Jet



Rain



**Cromato**  
Chromed

**Realizzato in acciaio inox, ottone e ABS**

Made of stainless steel, brass and ABS

Réalisé en acier inox, laiton et ABS

Hergestellt aus Edelstahl, Messing und ABS

Realizado en acero inox, latón y ABS

Изготовлено из нержавеющей сталь, латунь и АБС



**STAR 05 - GYSH10205**

Ø 20 x 5 cm



**STAR 04 - GYSH10204**

Ø 25 x 6 cm

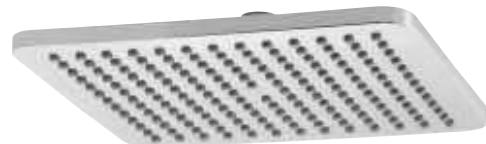

**STAR 02 - GYSH10202**

25 x 25 x 6 cm

**Plus.**

GEDY



1 Jet



Rain



**Nero matt**  
Matt black

**Realizzato in ottone e ABS**

Made of brass and ABS

Réalisé en laiton et ABS

Hergestellt aus Messing und ABS

Realizado en latón y ABS

Изготовлено из латунь и АБС



**PLUS 07 - GYSH10107**

Ø 22,5 x 5 cm



**Realizzato in acciaio inox, ottone e ABS**

Made of stainless steel, brass and ABS

Réalisé en acier inox, laiton et ABS

Hergestellt aus Edelstahl, Messing und ABS

Realizado en acero inox, latón y ABS

Изготовлено из нержавеющей сталь, латунь и АБС



1 Jet



Rain



**Nichel spazzolato**  
Brushed nickel



**PLUS 06 - GYSH10106**

Ø 23 x 5 cm



**Cromato/Bianco**  
Chromed/White



**PLUS 04 - GYSH10104**

Ø 22,6 x 5,6 cm



**Cromato**  
Chromed



**PLUS 05 - GYSH10105**

Ø 23 x 5 cm



**Cromato**  
Chromed



**PLUS 03 - GYSH10103**

20 x 20 x 6,5 cm



**Cromato**  
Chromed



**PLUS 02 - GYSH10102**

Ø 20 x 6,9 cm



**Cromato**  
Chromed



**PLUS 01 - GYSH10101**

Ø 20 x 5,4 cm



**Cromato**  
Chromed

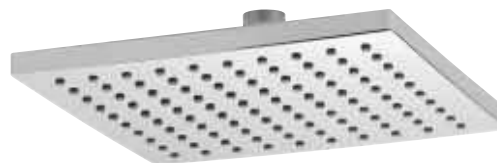

**PLUS 00 - GYSH10100**

20 x 20 x 5 cm

**Easy.**

GEDY



**Cromato**  
Chromed

**Realizzato in acciaio inox, ottone e ABS**

Made of stainless steel, brass and ABS

Réalisé en acier inox, laiton et ABS

Hergestellt aus Edelstahl, Messing und ABS

Realizado en acero inox, latón y ABS

Изготовлено из нержавеющей сталь, латунь и АБС



**EASY 04 - GYSH10004**

Ø 10 x 8,5 cm



**5 Jets**



**Rain**



**Tonic**



**Massage**



**Rain+Tonic**



**Rain+Massage**



**1 Jet**



**Rain**



**EASY 03 - GYSH10003**

Ø 10,2 x 6,5 cm



**EASY 01 - GYSH10001**

Ø 7 x 10,5 cm



**EASY 00 - GYSH10000**

Ø 7,2 x 9,5 cm



## Light.

GEDY



1 Jet



Rain



Cromato  
Chromed

**Realizzato in acciaio inox, ottone e ABS**

Made of stainless steel, brass and ABS

Réalisé en acier inox, laiton et ABS

Hergestellt aus Edelstahl, Messing und ABS

Realizado en acero inox, latón y ABS

Изготовлено из нержавеющей сталь, латунь и АБС



**LIGHT 03 - GYSH10703**

Ø 25 x 8 cm



Color  
change



**LIGHT 00 - GYSH10700**

Ø 20,5 x 8 cm



Color  
change

## Liberty.

GEDY



1 Jet



Rain

**Realizzato in acciaio inox, ottone e ABS**

Made of stainless steel, brass and ABS

Réalisé en acier inox, laiton et ABS

Hergestellt aus Edelstahl, Messing und ABS

Realizado en acero inox, latón y ABS

Изготовлено из нержавеющей сталь, латунь и АБС



Cromato  
Chromed



**LIBERTY 00 - GYSH10600**

Ø 20,5 x 10,8 cm



Bronzo  
Bronze



**LIBERTY 01 - GYSH10601**

Ø 20,5 x 10,8 cm



Rame  
Copper



**LIBERTY 02 - GYSH10602**

Ø 20,5 x 10,8 cm

## Music.

GEDY



1 Jet



Rain



**MUSIC 00 - GYSH11100**

Ø 23 x 9 cm



Cromato/Bianco  
Chromed/White



Bluetooth



GARANZIA  
WARRANTY

## Flessibili Hoses

**Tutti dotati di attacco universale 1/2" e di doppia aggraffatura,  
i flessibili GEDY sono presentati in un ampio ventaglio di materiali, finiture e misure disponibili.**

All complete with universal 1/2" fitting and dual crimping.  
GEDY hoses are available in a wide range of materials, finishes and sizes.

Tous munis d'un raccord universel de 1/2 pouces et d'un double agrafage, les tuyaux flexibles GEDY sont présentés dans une vaste gamme de matériaux, de finitions et de dimensions.

Alle ausgestattet mit Universalanschluss 1/2" und doppelter Rändelung: die Schläuche GEDY werden in einer Vielzahl von Materialien, Verarbeitungen und Größen angeboten.

Todos dotados de conexión universal 1/2" y de engrapado doble, los flexos GEDY están disponibles con un amplio abanico de materiales, acabados y medidas.

Все шланги GEDY в двойной оплетке и имеют универсальное соединение 1 / 2", в наличии большой выбор материалов, отделок и размеров.



Risparmio idrico  
Water saving



Universale  
Standard



Antitorsione  
Anti-Twist



Resistente  
alle piegature  
Anti-Fold



Resistent  
Resistente

## Brass.

GEDY



Doppia aggraffatura  
Double Lock



Cromato  
Chromed

### Realizzato in ottone

Made of brass  
Réalisé en laiton  
Hergestellt aus Messing  
Realizado en latón  
Изготовлено из латунь

**BRASS 04 - GYFX10004**

Ø 1,4 x 150 - 200 cm

## Black Plus.

GEDY



Nero matt  
Matt black



**BLACK PLUS 01 - GYFX10901**

Ø 1,4 x 200 cm

**BLACK PLUS 00 - GYFX10900**

Ø 1,4 x 150 cm

## Black.

GEDY



Nero matt  
Matt black



**BLACK 01 - GYFX10801**

Ø 1,4 x 200 cm

**BLACK 00 - GYFX10800**

Ø 1,4 x 150 cm

## Silver.

GEDY



Argento  
Silver



**SILVER 01 - GYFX10701**

Ø 1,4 x 200 cm

**SILVER 00 - GYFX10700**

Ø 1,4 x 150 cm

## Super Black.

GEDY



Cromato/Nero  
Chromed/Black

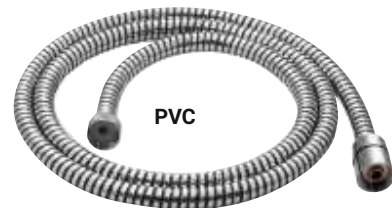

**SUPER BLACK 01 - GYFX10601**

Ø 1,4 x 200 cm

**SUPER BLACK 00 - GYFX10600**

Ø 1,4 x 150 cm

## Super White.

GEDY



Cromato/Bianco  
Chromed/White

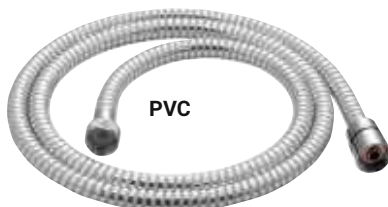

**SUPER WHITE 01 - GYFX10501**

Ø 1,4 x 200 cm

**SUPER WHITE 00 - GYFX10500**

Ø 1,4 x 150 cm

## Double White.

GEDY



Cromato/Bianco  
Chromed/White



**DOUBLE WHITE 01 - GYFX10301**

Ø 1,4 x 200 cm

**DOUBLE WHITE 00 - GYFX10300**

Ø 1,4 x 150 cm

# Inox.

**GEDY**

**Realizzato in acciaio inox, ottone e PVC**

Made of stainless steel, brass and PVC - Réalisé en acier inox, laiton et PVC - Hergestellt aus Edelstahl, Messing und PVC - Realizado en acero inox, latón y PVC  
Изготовлено из нержавеющей сталь, латунь и PVC



**Cromato**  
Chromed



**INOX 13 - GYFX10113**

Ø 1,4 x 60 cm



**Inox spazzolato**  
Brushed steel



**INOX 12 - GYFX10112**

Ø 1,4 x 200 cm



**INOX 11 - GYFX10111**

Ø 1,4 x 150 cm



**Bronzo**  
Bronze



**INOX 06 - GYFX10106**

Ø 1,4 x 200 cm



**Rame**  
Copper



**INOX 08 - GYFX10108**

Ø 1,4 x 200 cm



**Doppia aggraffatura**  
Double Lock

**INOX 05 - GYFX10105**

Ø 1,4 x 150 cm



**Doppia aggraffatura**  
Double Lock

**INOX 07 - GYFX10107**

Ø 1,4 x 150 cm



**Cromato**  
Chromed



**INOX 04 - GYFX10104**

Ø 1,4 x 150 - 200 cm



**Cromato**  
Chromed



**INOX 03 - GYFX10103**

Ø 1,4 x 200 cm



**Doppia aggraffatura**  
Double Lock



**Doppia aggraffatura**  
Double Lock

**INOX 02 - GYFX10102**

Ø 1,4 x 150 cm



**Cromato**  
Chromed



**INOX 01 - GYFX10101**

Ø 1,4 x 200 cm

**INOX 00 - GYFX10100**

Ø 1,4 x 150 cm

**Realizzato in acciaio inox e ottone**

Made of stainless steel and brass  
Réalisé en acier inox et laiton  
Hergestellt aus Edelstahl und Messing  
Realizado en acero inox y latón  
Изготовлено из нержавеющей сталь и латунь



GARANZIA  
WARRANTY

## Accessori Accessories

**Varie possibilità di sostituzione di accessori e particolari per la zona doccia, dai supporti per le doccette e i saliscendi, ai kit per la sostituzione areatori in varie misure, alle prese d'acqua, deviatori e braccetti con connessione universale.**

A host of replacement possibilities for accessories and details for the shower area, from brackets to sliding bars, kits for aerator replacement in different sizes, water inlets, deflectors and brackets with universal connection.

Différentes possibilités de remplacement d'accessoires et de pièces pour la zone douche : supports de douchette, barres de douche, kits pour le remplacement des aérateurs dans différentes dimensions, prises d'eau, déviateurs et bras avec connexion universelle.

Erschiedene Möglichkeiten der Ersetzung von Zubehör- und Ersatzteile im Duschenbereich, von den Handduschenhalterungen zu den Wandschienen und von den Kits für die Ersetzung der Lüfter in verschiedenen Größen zu den Wasseranschlüssen, Umleitern und Armen mit Universalansschluss.

Varias posibilidades de sustitución de accesorios y detalles para la zona ducha, desde los soportes para los mangos de ducha y los soportes deslizantes, los kits para la sustitución aireadores de varias medidas, hasta las toma de agua, los desviadores y los brazos con conexión universal.

Богатый ассортимент аксессуаров и дополнений для душа, начиная от держателей для ручных душей и штанг до наборов для смены аэраторов различных размеров, соединений для подвода воды, девиаторов и держателей с универсальным креплением.



Universale  
Standard

**Realizzati in ABS, acciaio inox e ottone**

Made of ABS, stainless steel and brass

Réalisés en ABS, acier inoxydable and laiton

Hergestellt aus ABS, Edelstahl und Messing

Realizados en ABS, acero inox y latón

Изготовлено из АБС, нержавеющей стали и латуны

## Bar Liberty.

GEDY



**Cromato**  
Chromed

ø 2,5 cm

**BAR LIBERTY 00 - GYAC10300**

8 x 16 x 74 cm



**Bronzo**  
Bronze

ø 2,5 cm

**BAR LIBERTY 01 - GYAC10301**

8 x 16 x 74 cm



**Rame**  
Copper

ø 2,5 cm

**BAR LIBERTY 02 - GYAC10302**

8 x 16 x 74 cm

## Bar Tendance.

GEDY



**Cromato/Bianco**  
Chromed/White



ø 2,5 cm

**BAR TENDENCE 02**  
GYAC10202  
13,5 x 20 x 81 cm



**Cromato/Nero**  
Chromed/Black



ø 2,5 cm

**BAR TENDENCE 03**  
GYAC10203  
13,5 x 20 x 81 cm



**Bianco**  
White



**BAR TENDENCE 00**  
GYAC10200  
12 x 7,5 x 66 cm



**Nero**  
Black



**BAR TENDENCE 01**  
GYAC10201  
12 x 7,5 x 66 cm

## Bar Star.

GEDY



**Cromato**  
Chromed



ø 2,5 cm

**BAR STAR 00**  
GYFX10100  
12,4 x 7,3 x 75 cm



**Cromato**  
Chromed



ø 2,5 cm

**BAR STAR 01**  
GYAC10101  
11 x 7,2 x 75,5-87 cm



**Nichel spazzolato**  
Brushed nickel



ø 2,5 cm

**BAR STAR 02**  
GYAC10102  
11 x 7,2 x 75,5-87 cm



**Lucido**  
Polished



ø 1,9 cm

**BAR EASY 00**  
GYAC10000  
11,6 x 8 x 60,5 cm

## Bar Easy.

GEDY

## Slider.

GEDY



Cromato  
Chromed



**SLIDER 04 - GYAC99004**

11,3 x 3,6 x 3,6 cm



**SLIDER 01 - GYAC99001**

11,6 x Ø 3,7 cm

**Idoneo per  
aste Ø 19 mm**  
Suitable for  
shower rails Ø 19 mm



**SLIDER 03 - GYAC99003**

11 x Ø 4 cm



**SLIDER 00 - GYAC99002**

12 x Ø 4 cm

**Idoneo per  
aste Ø 25 mm**  
Suitable for  
shower rails Ø 25 mm

**con riduttori  
Ø 18 - 25 mm**  
with reducers  
Ø 18 - 25 mm

### Supporti doccetta universali per asta saliscendi

Universal head shower supports for sliding rail

## Clip Liberty.

GEDY



Cromato  
Chromed

ABS



**CLIP LIBERTY 04**

GYAC10804

Ø 6 x 10 cm



Cromato  
Chromed

Cromall®



**CLIP LIBERTY 00**

GYAC10800

Ø 6 x 10 cm



Rame  
Copper



**CLIP LIBERTY 02**

GYAC10802

Ø 6 x 10 cm

### Supporto doccia mobile

Mobile shower bracket

## Clip Tech.

GEDY



Cromato  
Chromed

ABS



**CLIP TECH 00**

GYAC10700

9 x 7 x 4,2 cm

### Supporto doccia mobile

Mobile shower bracket

## Clip Star.

GEDY



Cromato  
Chromed



**CLIP STAR 00**  
GYAC10600

7,1 x 10,2 x 3,4 cm

**Supporto doccia mobile**  
Mobile shower bracket

ABS

## Clip Plus.

GEDY

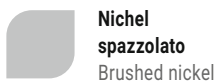

Nichel  
spazzolato  
Brushed nickel



Cromato/Nero  
Chromed/Black

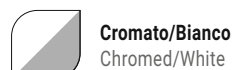

Cromato/Bianco  
Chromed/White

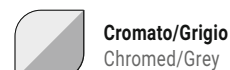

Cromato/Grigio  
Chromed/Grey



**CLIP PLUS 03**  
GYAC10503

4,2 x 6,5 x 5,8 cm



**CLIP PLUS 02**  
GYAC10502

4,2 x 6,5 x 5,8 cm



**CLIP PLUS 01**  
GYAC10501

4,2 x 6,5 x 5,8 cm



**CLIP PLUS 00**  
GYAC10500

4,2 x 6,5 x 5,8 cm

ABS

**Supporto doccia mobile**  
Mobile shower bracket

## Clip Easy.

GEDY



Cromato  
Chromed

ABS



**2 posizioni**  
2 positions

**CLIP EASY 02**  
GYAC10402

Ø 9,6 x 6 x 8,6 cm



Con ventosa  
With suction  
cup

Solo su superfici lisce  
(specchi, piastrelle)  
For flat surfaces  
(mirrors, tiles) only



**1 posizione**  
1 position

**CLIP EASY 01**  
GYAC10401

Ø 6 x 6,8 cm



**CLIP EASY 00**  
GYAC10400

Ø 4 x 5 cm

**Supporto doccetta fisso**  
Fixed shower bracket

**Connessione universale**  
Universal connection



## Oxy Mix Clip.

GEDY

**Preso acqua con rubinetto d'arresto con supporto**  
Water inlet with on-off mixer and support

  
Cromato  
Chromed



Ottone  
Brass

**OXY MIX CLIP 04 - GYAC11604**

9,5 x 6,8 x 5,4 cm



**OXY MIX CLIP 03 - GYAC11603**

9,8 x 7 x 6,5 cm

## Oxy Mix.

GEDY

**Preso acqua con rubinetto d'arresto**  
Water inlet with on-off mixer

  
Cromato  
Chromed



Ottone  
Brass

**OXY MIX 02 - GYAC11602**

5 x 7,6 x 5,2 cm



**OXY MIX 01 - GYAC11601**

6 x 7,2 x 5,2 cm

## Oxy Clip Plus.

GEDY

**Preso acqua con supporto**  
Water inlet with support

  
Cromato  
Chromed



Ottone  
Brass

**OXY CLIP PLUS 00 - GYAC11400**

4 x 8,5 x 5,5 cm

GEDY

**Preso acqua con supporto**  
Water inlet with support

  
Nero matt  
Matt black



Ottone  
Brass

NEW

**OXY CLIP PLUS 01 - GYAC11401**

4 x 8,5 x 5,5 cm

## Oxy Clip Easy.

GEDY

**Preso acqua con supporto**  
Water inlet with support

  
Cromato  
Chromed



Ottone  
Brass

**OXY CLIP EASY 00 - GYAC11300**

4 x 8 x 5,8 cm

GEDY

**Preso acqua con supporto**  
Water inlet with support

  
Nero matt  
Matt black



Ottone  
Brass

NEW

**OXY CLIP EASY 01 - GYAC11301**

4 x 8 x 5,8 cm

## Oxy Tech.

GEDY



**Cromato**  
Chromed



**Presacqua**  
Water inlet

**Ottone**  
Brass

**OXY TECH 00 - GYAC11200**

4,7 x 6 x 5 cm

## Oxy Star.

GEDY



**Cromato**  
Chromed



**Presacqua**  
Water inlet

**Ottone**  
Brass

**OXY STAR 00 - GYAC11100**

5 x 6 x 5 cm

## Oxy Plus.

GEDY

**Presacqua**  
Water inlet



**Nichel spazzolato**  
Brushed nickel



**Rame**  
Copper



**Bronzo**  
Bronze



**Cromato**  
Chromed

**Ottone**  
Brass



**OXY PLUS 03**  
GYAC11003

5 x 5,5 x 6,5 cm



**OXY PLUS 02**  
GYAC11002

5 x 5,5 x 6,5 cm



**OXY PLUS 01**  
GYAC11001

5 x 5,5 x 6,5 cm



**OXY PLUS 00**  
GYAC11000

5 x 5,5 x 6,5 cm

## Oxy Easy.

GEDY

**Presacqua**  
Water inlet



**Nichel spazzolato**  
Brushed nickel



**Rame**  
Copper



**Bronzo**  
Bronze



**Cromato**  
Chromed

**Ottone**  
Brass



**OXY EASY 03**  
GYAC10903

6 x 7 x 3,7 cm



**OXY EASY 02**  
GYAC10902

6 x 7 x 3,7 cm



**OXY EASY 01**  
GYAC10901

6 x 7 x 3,7 cm



**OXY EASY 00**  
GYAC10900

6 x 7 x 3,7 cm



**Cromato**  
Chromed



**OXY EASY 05**  
GYAC10905

6 x 7 x 3,7 cm



**Cromato**  
Chromed



**OXY EASY 04**  
GYAC10904

6,2 x 4,8 x 5,2 cm

**ABS**

## Soap Easy.

GEDY

da  $\varnothing$  18 a 25 mm  
from  $\varnothing$  18 to 25 mm

Cromato  
Chromed

ABS



Portasapone per saliscendi doccia  
Soap holder for sliding bar

**SOAP EASY 00**  
GYAC11700  
8,1 x 16,6 x 3,5 cm

## Soapy Star.

GEDY

da  $\varnothing$  18 a 25 mm  
from  $\varnothing$  18 to 25 mm

Cromato  
Chromed

ABS



Mensola per saliscendi e colonna doccia  
Shelf for shower bar and shower column

**SOAP STAR 00**  
GYAC11800  
25 x 9,6 x 3,2 cm

## Cross Trendy.

GEDY

2 vie - 2-way



Cromato  
Chromed

Ottone  
Brass



Deviatore acqua per colonna doccia  
Water diverter for shower column

**CROSS TRENDY 00**  
GYAC12000  
6 x 3 x 6,2 cm

## Cross Easy.

GEDY



Cromato  
Chromed

Universale  
Universal

2 vie a cartuccia  
2-way cartridge



**CROSS EASY 00 - GYAC11900**  
6,5 x 2,8 x 6,5 cm

Ottone  
Brass

2 vie  
2-way

ABS



**CROSS EASY 05 - GYAC11905**  
6,5 x 2,5 x 6,5 cm



**CROSS EASY 04 - GYAC11904**  
7 x 2,3 x 7,5 cm

## Tube Liberty.

GEDY

**Acciaio inox**  
Stainless steel



**Cromato**  
Chromed



**Bronzo**  
Bronze



**Rame**  
Copper

**TUBE LIBERTY 00 - GYAC13800**

5,2 x 31,5 x 28,6 cm

**TUBE LIBERTY 01 - GYAC13801**

5,2 x 31,5 x 28,6 cm

**TUBE LIBERTY 02 - GYAC13802**

5,2 x 31,5 x 28,6 cm

## Tube Top.

GEDY

**Acciaio inox AISI 304**  
AISI 304 stainless steel



**Cromato**  
Chromed

100 %  
AISI  
304

**TUBE TOP 45 00 - GYAC13700**

5,9 x 47,5 x 5,9 cm

**TUBE TOP 35 00 - GYAC13500**

3,5 x 35 x 1,5 cm

**TUBE TOP 40 00 - GYAC13600**

5,9 x 42,4 x 5,9 cm

**TUBE TOP 30 00 - GYAC13400**

3,5 x 30 x 1,5 cm

## Tube Tech.

GEDY

**Ottone**  
Brass



**Cromato**  
Chromed

**TUBE TECH 35 00 - GYAC13200**

6 x 37,5 x 9 cm

**TUBE TECH 30 00 - GYAC13100**

6 x 32,5 x 9 cm

**TUBE TECH 25 00 - GYAC13000**

6 x 27,5 x 9 cm

## Tube Trendy.

GEDY

**Ottone**  
Brass



**Cromato**  
Chromed

**TUBE TRENDY 15 00 - GYAC12500**

2,5 x 2,5 x 15 cm

## Tube Plus.

GEDY

**Acciaio inox**  
Stainless steel



**Cromato**  
Chromed

**TUBE PLUS 15 00 - GYAC12300**

Ø 6 x 15 cm



**Nichel spazzolato**  
Brushed nickel

**TUBE PLUS 6 03 - GYAC12203**

Ø 2 x 6 cm

## Tube Star.

GEDY

**Acciaio inox**  
Stainless steel



**Cromato**  
Chromed

**TUBE STAR 40 00 - GYAC12900**

Ø 5,5 x 41,5 x 11,5 cm

**TUBE STAR 30 00 - GYAC12700**

Ø 5,5 x 30 x 11,5 cm

**TUBE STAR 35 00 - GYAC12800**

Ø 5,5 x 35 x 11,5 cm

**TUBE STAR 25 00 - GYAC12600**

Ø 5,5 x 26 cm x 11,5 cm



**Nero matt**  
Matt Black



**TUBE STAR 35 04 - GYAC12804**

Ø 5,5 x 35 x 11,5 cm



**Nichel spazzolato**  
Brushed nickel



**TUBE STAR 35 03 - GYAC12803**

Ø 5,5 x 35 x 11,5 cm



**Rame**  
Copper



**TUBE STAR 35 02 - GYAC12802**

Ø 5,5 x 35 x 11,5 cm



**Bronzo**  
Bronze



**TUBE STAR 35 01 - GYAC12801**

Ø 5,5 x 35 x 11,5 cm

## Tube Easy.

GEDY

**Acciaio inox**  
Stainless steel



**Cromato**  
Chromed

**TUBE EASY 00 - GYAC12100**

Ø 2 x 15 cm

## Spray Tech.

GEDY

**Ottone**  
Brass



**Cromato**  
Chromed



**SPRAY TECH 01 - GYAC99301**

6,2 x 12,4 x 2,2 cm



**SPRAY TECH 00 - GYAC99300**

5,8 x 12,4 x 2,2 cm

**Doccetta shut-off**  
Shut-off hand shower



GARANZIA  
WARRANTY

## Idraulica Taps accessories

Accessoires de robinet - Wasserzähler-Zubehör  
Accesorios de fontanería - Сантехнические принадлежности

### Flexy.

GEDY

**PVC e Acciaio inox**  
PVC and Stainless steel



**Cromato**  
Chromed



**FLEXY 03 - GHHY10003**

Ø 3 x 6 cm

**Tubo con areatore per miscelatore lavello cucina - Connessione universale**

Pipe with aerator for kitchen sink mixer - Universal connection



**Bianco**  
White



**FLEXY 00 - GHHY10000**

Ø 3 x 15 cm



**FLEXY 01 - GHHY10001**

Ø 3 x 9 cm

### Water Saving.

GEDY

**Riduttore di portata d'acqua**

Flow reducer

**ABS e Ottone**  
ABS and Brass



**Cromato**  
Chromed



**WATER SAVING 02**

GHHY10402

Ø 3 x 4,2 cm



**WATER SAVING 01**

GHHY10401

Ø 2,2 x 2 cm

### Joint.

GEDY

**Snodo per bidet con areatore**

Joint for bidet with aerator

**Ottone e Acciaio inox**  
Brass and Stainless steel



**Cromato**  
Chromed



**JOINT 01**

GHHY10501

Ø 2,5 x 4,5 cm



**JOINT 00**

GHHY10500

Ø 2,5 x 4,5 cm

## Aerator.

GEDY

**Gomma, acciaio inox e ottone**  
Rubber, stainless steel and brass



**Cromato**  
Chromed



**AERATOR 01**  
GHHY10701  
Ø 2,2 x 1 cm

## Key.

GEDY

**Chiavetta per aeratori**  
Aerator key

ABS



**KEY 00**  
GHHY10600  
5 x 2 x 8 cm

## Funny.

GEDY



**Non compatibile  
per le vasche da bagno**  
Not fitting for bath tubs



**Antivandalo  
Vandal-Pro**



**Con magnete  
With magnet**



**Anti ossidazione  
Anti oxidation**



**Cover intercambiabile  
Interchangeable cover**



**Sistema H-Look  
H-Look system**



**FUNNY - GHHY20000**

**Tappo universale per lavabo e bidet  
con cover intercambiabili e magnetiche  
resine termoplastiche e metallo**

Universal washbasin and bidet plug  
with interchangeable, magnetic covers  
thermoplastic resins and metal

Clapet universel pour bonde de lavabo et bidet  
avec bouchons magnétiques interchangeables  
thermoplastique et métal

Universalstöpsel für Waschbecken und Bidet  
mit austauschbaren und magnetischen Covers  
Kunststoff und Metall

Tapón universal para lavabo y bidet  
con tapas intercambiables y magnéticas  
resina termoplásticas y metal

Универсальная пробка для раковины и  
биде со сменными магнитными крышками  
термопластиченых смол и металл



### Cover assortite Ø 3,8/Ø 6,3 cm

Assorted covers Ø 3,8/Ø 6,3 cm

Bouchons assortis Ø 3,8/Ø 6,3 cm

Cover-Sortiment Ø 3,8/Ø 6,3 cm

Diferentes modelos de tapas Ø 3,8/Ø 6,3 cm

Крышки в ассортименте Ø 3,8/Ø 6,3 cm



REVO



**reddot award 2016  
winner**





C O N T R A C T







CONTRACT.

## Distributori di sapone e gel igienizzante

Dispensers for soap and sanitizer gel - Distributeurs de savon et gel désinfectant  
Spender für Seife und für Desinfektiongel

Dosificadores de jabón y gel desinfectante - Диспенсеры для мыла и Гель-антисептик



### Giava.

TOP DESIGN

**Vetro e Cromall®**  
Glass and Cromall®  
Verre et Cromall®  
Glas und Cromall®  
Cristal y Cromall®  
Стекло и Cromall®

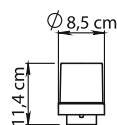

**G081**

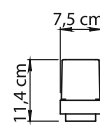

**G082**



13  
**Cromato**  
Chromed



Eco-Friendly  
& Antigoccia  
Eco-Friendly  
& Drop Free

## A681 Maldive.

TOP DESIGN

**Ottone, Cromall® e Tritan™**  
 Brass, Cromall® and Tritan™  
 Laiton, Cromall® et Tritan™  
 Messing, Cromall® und Tritan™  
 Latón, Cromall® y Tritan™  
 Латунь, Cromall® и Tritan™

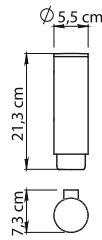

Struttura  
antivandalo  
Vandal-Pro  
of structure

Eco-Friendly  
& Antigoccia  
Eco-Friendly  
& Drop Free

13  
Cromato  
Chromed

## G180 Zanzibar.

NEW

TOP DESIGN

**ABS, Cromall® e acciaio inox**  
 ABS, Cromall® and stainless steel  
 ABS, Cromall® et acier inox  
 ABS, Cromall® und Edelstahl  
 ABS, Cromall® y acero inox  
 АБС, Cromall® и нержавеющей сталь

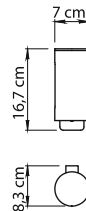

13  
Cromato  
Chromed

Struttura  
antivandalo  
Vandal-Pro  
of structure

Eco-Friendly  
& Antigoccia  
Eco-Friendly  
& Drop Free

## 2295 Bonito.

TOP DESIGN

### Distributore touchless di sapone o gel igienizzante

Touchless dispenser for soap or sanitizer gel  
 Distributeur sans contact de savon ou de gel désinfectant  
 Touchless-Spender für Seife oder Desinfektionsgel  
 Dosificador de jabón o gel desinfectante sin contacto  
 Бесконтактный диспенсер для мыла или геля-антисептика

### Acciaio inox AISI 304 e resine termoplastiche

Chromed AISI 304 stainless steel and thermoplastic resins  
 Acier inoxydable AISI 304 et résine thermoplastique  
 Verchromtem Edelstahl AISI 304 und Kunststoß  
 Acero inox AISI 304 y resinas termoplásticas  
 нержавеющей сталь AISI 304 и термопластические смолы

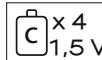
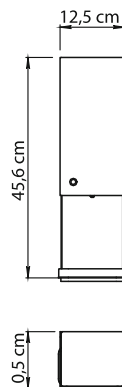

Batterie non include  
Batteries not included

Alimentatore 6V-DC non incluso  
6V-DC power supply (not included)

14  
Nero matt  
Matt black

38  
Spazzolato  
Brushed



Touchless



Struttura  
antivandalo  
Vandal-Pro  
of structure

Idoneo per  
gel igienizzante  
Suitable for  
sanitizer gel

CONTRACT.

# Seal.

GEDY

## Acciaio inox AISI 304, ottone, Cromall® e resine termoplastiche

Stainless steel AISI 304, brass, Cromall® and thermoplastic resins  
Acier inoxydable AISI 304, laiton, Cromall® et résine thermoplastique  
Edelstahl AISI 304, Messing, Cromall® und Kunststoff  
Acero inox AISI 304, latón, Cromall® y resinas termoplásticas  
Нержавеющей стали AISI 304, латунь, Cromall®  
и термопластичных



13  
Cromato  
Chromed



14  
Nero matt  
Matt black



2074



2079





## 2087 Kubix.

GEDY

### Acciaio inox e resine termoplastiche

Stainless steel and thermoplastic resins  
 Acier inoxydable et thermoplastique  
 Edelstahl und Kunststoff  
 Acero inox y resinas termoplásticas  
 Нержавеющей стали  
 и термопластичных смол

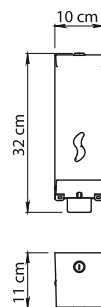

Safety lock



13  
**Lucido**  
 Polished

## Epos.

GEDY

### Acciaio inox AISI 304

Stainless steel AISI 304  
 Acier inoxydable AISI 304  
 Edelstahl AISI 304  
 Acero inoxidable AISI 304  
 Изготовлено из AISI 304

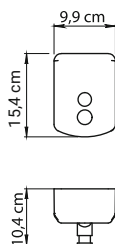

2080

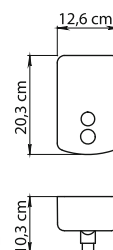

2083

NEW



21  
**Lucido/Spazzolato**  
 Polished/Brushed

## 2084.

GEDY

### Distributore di sapone da incasso per top lavabo con erogatore in metallo cromato

Built-in soap dispenser for washbasin top with chromed metal dispenser pump - Distributeur de savon à encastrer pour dessus de lavabo avec pompe en métal chromé - Einbau-Seifenspender für Waschbecken-Top mit Spender aus verchromtem Metall - Dosificador de jabón empotrado para encimera lavabo con dispensador en metal cromado - Встраиваемый дозатор для умывальника

### Ottone e resine termoplastiche

Brass and thermoplastic resins - Laiton et résine thermoplastique  
 Messing und Kunststoff - Latón y resinas termoplásticas - Латунь и термопластичных

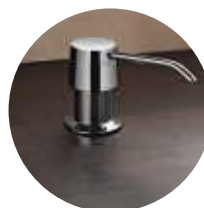

13  
**Cromato**  
 Chromed

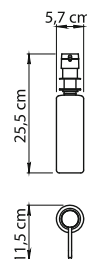

2084

CONTRACT.

**2290 Jelly.**

GEDY

ABS

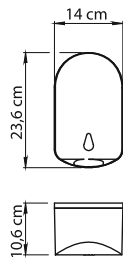

Idoneo per gel igienizzante

Touchless

02  
Bianco  
White

Suitable for satinizer gel

AA x 4 Batterie non include  
6V Batteries not included

**2090 Feel.**

GEDY

Resine termoplastiche

Thermoplastic resins

Résine thermoplastique

Kunststoff

Resinas termoplásticas

Термопластичные смолы

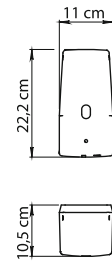

02  
Bianco  
White



Touchless

AA x 4 Batterie non include  
6V Batteries not included

**2291 Push Pro.**

GEDY

100% MADE  
in Italy



design Makio Hasuike

Resine termoplastiche e ABS

Thermoplastic resins and ABS

Thermoplastique et ABS

Kunststoff und ABS

Résinas termoplásticas y ABS

термопластических смол и ABS

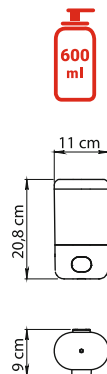

02  
Bianco  
White

Idoneo per gel igienizzante

Suitable for satinizer gel



Con colla  
With glue

Con viti  
With screws

(Venduta a parte  
Sold separately)

**Touch.**

GEDY

Resine termoplastiche

Thermoplastic resins

Résine thermoplastique

Kunststoff

Resinas termoplásticas

Термопластичные смолы

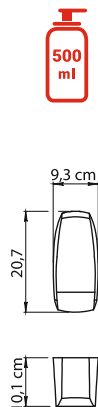

2088

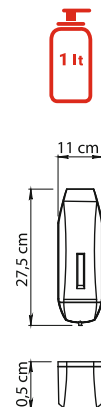

2089



02  
Bianco  
White

Distributori di sapone e gel igienizzante - Dispensers for soap and sanitizer gel.

### 2096 Shark.

GEDY

#### Resine termoplastiche

Thermoplastic resins  
Résine thermoplastique  
Kunststoff  
Resinas termoplásticas  
Термопластичные смолы



Eco  
Sapone - Soap



Sapone in schiuma  
Foam soap

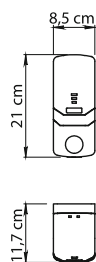

02  
Bianco  
White



13  
Cromato  
Chromed



Con biadesivo  
With double  
sided tape



Con viti  
With screws

### 2097 Cod.

GEDY

#### Resine termoplastiche

Thermoplastic resins  
Résine thermoplastique  
Kunststoff  
Resinas termoplásticas  
Термопластичные смолы

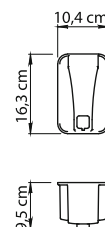

13  
Cromato  
Chromed



### 2078 Halibut.

GEDY

#### Resine termoplastiche

Thermoplastic resins  
Résine thermoplastique  
Kunststoff  
Resinas termoplásticas  
Термопластичные смолы

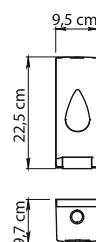

02  
Bianco  
White



13  
Cromato  
Chromed



Idoneo per  
gel igienizzante  
Suitable for  
sanitizer gel

### 2077 Squid.

GEDY

#### Resine termoplastiche

Thermoplastic resins  
Résine thermoplastique  
Kunststoff  
Resinas termoplásticas  
Термопластичные смолы

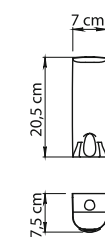

02  
Bianco  
White



13  
Cromato  
Chromed



Idoneo per  
gel igienizzante  
Suitable for  
sanitizer gel

CONTRACT.



## Mullet.

GEDY

### Resine termoplastiche

Thermoplastic resins  
Résine thermoplastique  
Kunststoff  
Resinas termoplásticas  
Термопластичные смолы



2294

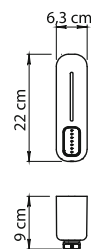

02  
Bianco  
White



13  
Cromato  
Chromed



14  
Nero matt  
Matt black



350  
ml



Idoneo per  
gel igienizzante

Suitable for  
satinizer gel



## 2092 Snapper.

GEDY

### Resine termoplastiche

Thermoplastic resins  
 Résine thermoplastique  
 Kunststoff  
 Resinas termoplásticas  
 Термопластичные смолы

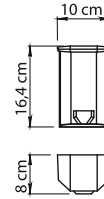

02  
 Bianco  
 White



## Torpedo.

GEDY

### Resine termoplastiche

Thermoplastic resins  
 Résine thermoplastique  
 Kunststoff  
 Resinas termoplásticas  
 Термопластичные смолы

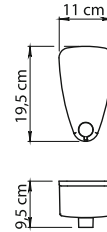

02  
 Bianco  
 White



2094

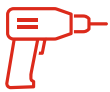

Con viti  
 With screws

Con colla  
 With glue

(Venduta a parte  
 Sold seperately)



Struttura  
 antivandalo  
 Vandal-Pro  
 of structure

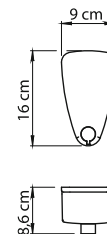

02  
 Bianco  
 White



13  
 Cromato  
 Chromed



2093

## 2091 Marlin.

GEDY

### Resine termoplastiche

Thermoplastic resins  
 Résine thermoplastique  
 Kunststoff  
 Resinas termoplásticas  
 Термопластичные смолы



02  
 Bianco  
 White



13  
 Cromato  
 Chromed



CONTRACT.

## 2293 Chromis.

GEDY

### Acciaio inox e ABS

Stainless steel and ABS  
Acier inoxydable et ABS  
Edelstahl und ABS  
Acero inoxidable y ABS  
Нержавеющая сталь и ABS



 x 4 Batterie non incluse  
6V Batteries not included

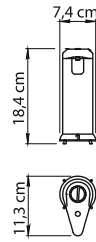

  
Idoneo per  
gel igienizzante  
Suitable for  
satinizer gel



13  
**Lucido**  
Polished



Touchless

## 2292 Oyster.

GEDY

ABS



 x 4 Batterie non incluse  
6V Batteries not included

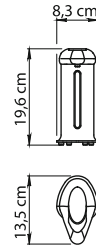

  
Idoneo per  
gel igienizzante  
Suitable for  
satinizer gel



02  
**Bianco**  
White



Touchless

## Agave.

GEDY

### Resine termoplastiche

Thermoplastic resins  
Résine thermoplastique  
Kunststoff  
Resinas termoplásticas  
Термопластичные смолы



2157



S9  
**Ambra**  
Amber



Idoneo per  
gel igienizzante  
Suitable for  
satinizer gel



2158



## Phon con supporto a parete

Hair dryer with wall support - Sèche cheveux avec support mural  
Haartrockner mit Wandhalter - Secador de pelo con soporte y toma  
Настенный фен для волос

### 5054 Grecale Shaver.

GEDY

#### Con presa rasoio

With electrical socket for shavers  
Avec prise pour les rasoirsacier  
Mit Steckdose für Rasierapparate  
Con toma de corriente para máquina de afeitar  
С розеткой для электробритов

#### Resine termoplastiche e acciaio inox

Thermoplastic resins and stainless steel  
Thermoplastique et acier inoxydable  
Kunststoff und Edelstahl  
Resinas termoplásticas y acero inox  
Термопластическая смола и нержавеющая сталь



1300W - IP23 - 220-240 V - 50-60 Hz



43  
Nero/Cromato  
Black/Chromed

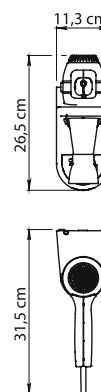

### 5057 Levante.

GEDY

ABS



Pieghevole  
Folding



02  
Bianco  
White



1650 W - IP20 - 220-240 V - 50-60 Hz

### 5058 Maestrale.

GEDY

ABS

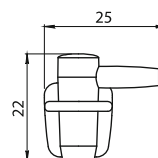

02  
Bianco  
White



1800W - IP20 - 220-240 V - 50-60 Hz

CONTRACT.

## 5053 Zefiro.

GEDY

### Resine termoplastiche

Thermoplastic resins  
Résine thermoplastique  
Kunststoff  
Resinas termoplásticas  
Термопластичные смолы



1200 W - IP20 - 220-240 V - 50-60 Hz

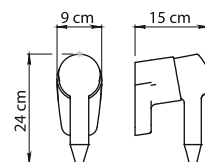

02  
Bianco  
White

## 5052 Albatros.

GEDY

design Ambrogio Rossari

### Resine termoplastiche

Thermoplastic resins  
Résine thermoplastique  
Kunststoff  
Resinas termoplásticas  
Термопластичные смолы

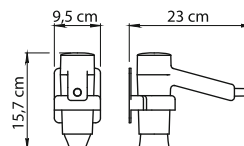

02  
Bianco  
White



1200 W - IPX0 - 230 V

## Asciugamani elettrici

Air hand dryers - Sèche-mains - Händetrockner  
Secador de manos - Электрическая сушилка

## 2451 Burian.

GEDY

### Asciugamani antivandalo ad aria calda con pulsante

Vandal-proof hot air hand dryer with pushbutton action  
Sèche-mains anti-vandalisme à air chaud avec bouton  
Bruchsicherer Heissluft-Händetrockner mit Taste  
Secador de aire caliente para las manos resistente  
al vandalismo con pulsador  
Сушилка для рук с защитой от вандалов,  
с горячим воздухом и кнопкой

### Acciaio porcellanato

Vitreous enamel steel - Acier émaillé  
Emaille - Acero porcelanizado  
Сталь, обработанная под фарфор



Struttura  
antivandalo  
Vandal-Pro  
of structure



02  
Bianco  
White

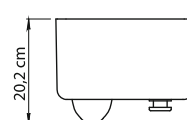
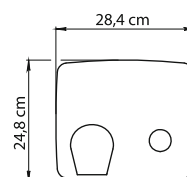

2400 W - IPX1  
220-240 V - 50-60 Hz

Asciugamani elettrici - Air hand dryes .

**2454 Bora.**

GEDY

**Asciugamani elettrico a fotocellula Eco-Jet**

Eco Jet electric hand dryer with photocell  
 Sèche-mains électrique à cellule photoélectrique Eco-Jet  
 Elektrischer Händetrockner mit Öko-Jet-Fotozelle  
 Secador de manos eléctrico con fotocélula Eco-Jet  
 Elektrische handdrogers met Eco-Jet fotocel  
 Электрическая сушилка для рук с фотоэлементом



Asciugatura  
10/15 sec.  
 Drying time  
10/15 sec.



Velocità aria  
300 Km/h  
 Speed air  
300 Km/h



Eco - Green  
Energy saving



Igiene  
integrata  
Integrated  
hygiene



02  
Bianco  
White



85  
Antracite  
satinato  
Anthracite  
satinized

**Polipropilene**

Polypropylene - Polypropylène  
 Polypropylen - Polipropileno  
 Полипропилен

**Acciaio inox**

Stainless steel - Acier inoxydable  
 Edelstahl - Acero inoxidable  
 Изготовлено из AISI 304

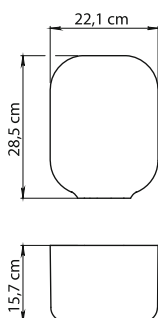

13  
Cromato  
Chromed



**Acciaio inox AISI 304**

Stainless steel AISI 304 - Acier inoxydable AISI 304  
 Edelstahl AISI 304 - Acero inoxidable AISI 304  
 Изготовлено из AISI 304



1100 W - IP23  
 220-240 V - 50-60 Hz

**2455 Alizé.**

GEDY

**Asciugamani elettrico a fotocellula Eco-Jet**

Eco Jet electric hand dryer with photocell  
 Sèche-mains électrique à cellule photoélectrique Eco-Jet  
 Elektrischer Händetrockner mit Öko-Jet-Fotozelle  
 Secador de manos eléctrico con fotocélula Eco-Jet  
 Elektrische handdrogers met Eco-Jet fotocel  
 Электрическая сушилка для рук с фотоэлементом



Asciugatura  
10/15 sec.  
 Drying time  
10/15 sec.



Velocità aria  
200 Km/h  
 Speed air  
200 Km/h



Eco - Green  
Energy saving



02  
Bianco  
White



13  
Cromato  
Chromed



21  
Satinato  
Satinized



14  
Nero  
Black

ABS

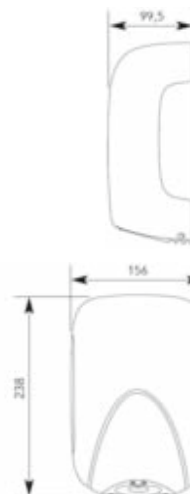

900 W - IP23 - 220-240 V - 50-60 Hz

CONTRACT.

## 2456 Brisa.

GEDY

### Asciugamani con motore ad induzione con fotocellula

Towel with induction motor and photocell  
Sèche-mains à moteur à induction à cellule  
photoélectrique  
Händetrockner mit Induktionsmotor  
und Fotozelle  
Secador de manos con motor  
de inducción con fotocélula  
Сушилка для рук с индукционным  
двигателем и фотоэлементом

ABS



1850 W - IPX2 - 220-240 V - 50-60 Hz

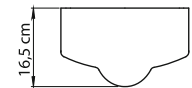
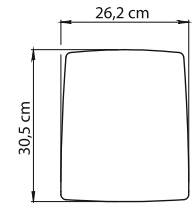
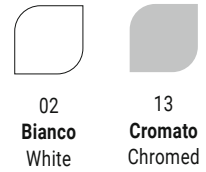

## 2453 Diablo.

GEDY

### Asciugamani elettrico a fotocellula Eco-Jet ad inserimento verticale delle mani

Photocell electronic hand-dryer  
with photocell for vertical insertion of hands  
Sèche-mains électrique à cellule photoélectrique Eco-  
Jet à introduction  
des mains verticale  
Elektrischer Händetrockner mit Öko-Jet-Fotozelle  
und vertikaler Handeinführung - Secador de manos  
eléctrico con fotocélula  
Eco-Jet con introducción vertical de las manos  
Электрическая сушилка для рук с фотоэлементом  
Eco-Jet, вертикальная

ABS



1450 W - IP34 - 220-240 V - 50-60 Hz  
582

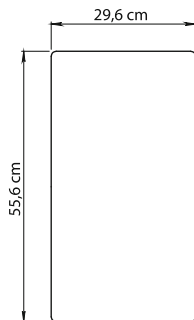

Asciugatura  
10/15 sec.  
Drying time  
10/15 sec.



Velocità aria  
410 Km/h  
Speed air  
410 Km/h



Eco-Green  
Energy saving



Igiene  
integrata  
Integrated  
hygiene

## Distributori di carta

Paper towel dispensers - Distributeur de serviettes

Papierspender - Dispensador de toallas

Ёмкость для бумаги

**2436.**

**GEDY**

**Distributore salviette carta**  
(max 26,5x9,5x32 cm)

**max 400 fogli**

Tissue dispenser - max 400 tissues  
Distributeur serviettes - max 400 serviettes  
Tuchspender - max 400 Tücher  
Dispensador de toallas - max 400 toallas  
Ёмкость для бумажных салфеток.  
максимальные 400 тканей

**Acciaio inox AISI 304**

Stainless steel AISI 304  
Acier inoxydable AISI 304  
Edelstahl AISI 304  
Нержавеющая сталь AISI 304



**15**  
YEARS

GARANZIA  
WARRANTY



13  
**Lucido**  
Polished



38  
**Spazzolato**  
Brushed

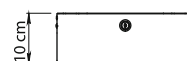
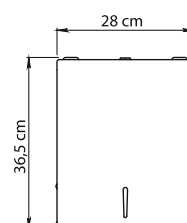

**NEW**

**100%**  
**AISI**  
**304**

**2251**  
**2251/01**

Compatibile  
Compatible



Serratura  
di sicurezza  
Safety lock

**2427.**

**GEDY**

**100% MADE**  
**in Italy**



**Distributore salviette carta**  
(max 25x10x37 cm)

**max 450 fogli**

Tissue dispenser - max 450 tissues  
Distributeur serviettes - max 450 serviettes  
Tuchspender - max 450 Tücher  
Dispensador de toallas - max 400 toallas  
Ёмкость для бумажных салфеток.  
максимальные 450 тканей

**Resine termoplastiche**

Thermoplastic resins  
Thermoplastique  
Kunststoff  
Resinas termoplásticas  
термопластичные смолы



**15**  
YEARS

GARANZIA  
WARRANTY



02  
**Bianco**  
White

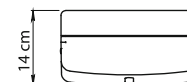
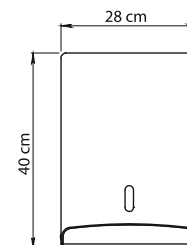

**2251**  
**2251/01**

Compatibile  
Compatible



Serratura  
di sicurezza  
Safety lock

C O N T R A C T .

**2426.**

GEDY

100% MADE  
in **Italy**



**Distributore salviette di carta piegate  
(max 24,5x10x24 cm - max 300 fogli)  
o a rotolo (max ø 14x24,5 cm)**

Dispenser for papersheets  
max 300 tissues - or paper-rolls  
Distributeur papier en feuilles  
max 400 serviettes - ou en rouleau  
Papierspender für Einzelblätter  
max 400 Tücher - oder Rollen  
Dispensador de toallitas  
max 400 toalla - o de papel en rollo  
Ёмкость для салфеток  
максимальные 400 тканей - или рулона

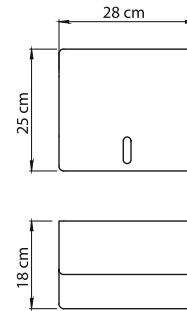

02  
**Bianco**  
White

2251  
2251/01  
2254

Compatibile

Compatibile

**2437.**

GEDY

100% MADE  
in **Italy**



**Distributore di carta asciugamani a spirale  
(max ø 16 x h. max 23 cm)**

Spiral paper hand towel dispenser  
Distributeur de papier essuie-mains en spirale  
Handtuchrollen-Spender  
Dispensador de toallitas para secar las manos en espiral  
Спиральный диспенсер бумаги для рук

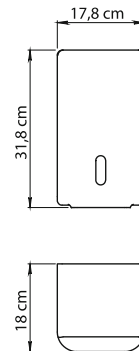

02  
**Bianco**  
White

2254

Compatibile

Compatibile

**2442.**

GEDY

**Distributore salviette carta - max 300 fogli  
(max 24,5 x 8,5 x 24 cm)**

Tissue dispenser - max 300 tissues  
Distributeur serviettes - max 300 serviettes  
Tuchspender - max 300 Tücher  
Dispensador de toallas - max 300 toallas  
Ёмкость для бумажных салфеток.  
максимальные 300 тканей

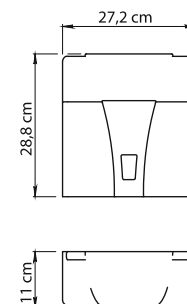

11  
**Azzurro**  
Light blue



02  
**Bianco**  
White

2251  
2251/01

Compatibile

Compatibile



**2440.**

**GEDY**

**Distributore salviette carta  
(max 23,8x8x26 cm) max 200 fogli**

Tissue dispenser - max 200 tissues  
Distributeur serviettes - max 200 serviettes  
Tuchspender - max 200 Tücher  
Dispensador de toallas - max 200 toallas  
Ёмкость для бумажных салфеток.  
максимальные 200 тканей

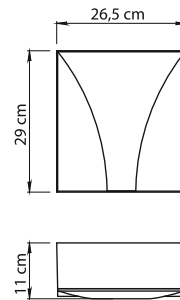

11  
**Azzurro**  
Light blue

**2251**  
**2251/01**

Compatibile  
Compatible

**Resine termoplastiche**

Thermoplastic resins  
Thermoplastique  
Kunststoff  
Resinas termoplásticas  
термопластичные смолы

**2424.**

**GEDY**

**Distributore per rotoli di carta igienica  
(max ø 30 cm)**

Rollpaper dispenser  
Distributeur papier à rouleau  
Rollenpapierspender  
Dispensador rollos de papel  
Ёмкость для туалетной бумаги

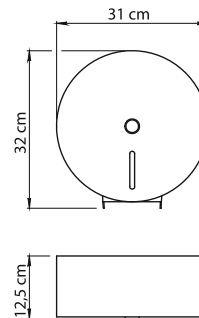

13  
**Lucido**  
Polished

**100%**  
**AISI**  
**304**

**2252**  
**2253**

Compatibile  
Compatible



Serratura  
di sicurezza  
Safety lock

**Acciaio inox AISI 304**

AISI 304 stainless steel - acier inoxydable AISI 304  
Edelstahl AISI 304 - acero inox AISI 304  
нержавеющая сталь AISI 304

**15**  
YEARS

GARANZIA  
WARRANTY

**2446.**

**GEDY**

**Distributore per rotoli di carta igienica  
(max ø 26 cm)**

Rollpaper dispenser  
Distributeur papier à rouleau  
Rollenpapierspender  
Dispensador rollos de papel  
Ёмкость для туалетной бумаги

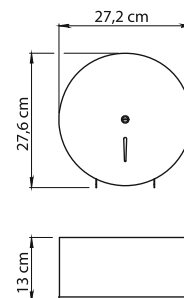

13  
**Lucido**  
Polished



38  
**Spazzolato**  
Brushed

**NEW**

**100%**  
**AISI**  
**304**

**2252**  
**2253**

Compatibile  
Compatible



Serratura  
di sicurezza  
Safety lock

**Acciaio inox AISI 304**

AISI 304 stainless steel  
acier inoxydable AISI 304  
Edelstahl AISI 304  
acero inox AISI 304  
нержавеющая сталь AISI 304

**15**  
YEARS

GARANZIA  
WARRANTY

C O N T R A C T .

## 2429 Jumbo Maxi.

100% MADE  
in Italy

GEDY

**Distributore per rotoli di carta igienica**  
(max ø 34 x 12 cm)

Rollpaper dispenser

Distributeur papier à rouleau

Rollenpapierspender - Dispensador rollos de papel

Ёмкость для туалетной бумаги

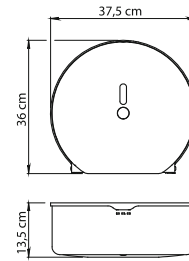

02  
Bianco  
White

2252  
2253

Compatibile  
Compatible

## 2428 Jumbo Mini.

100% MADE  
in Italy

GEDY

**Distributore per rotoli di carta igienica**  
(max ø 24,5 cm)

Rollpaper dispenser

Distributeur papier à rouleau

Rollenpapierspender - Dispensador rollos de papel

Ёмкость для туалетной бумаги

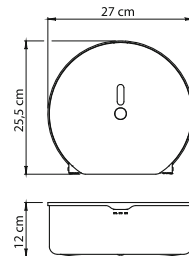

02  
Bianco  
White

2252

Compatibile  
Compatible

## 2443.

GEDY

**Distributore per rotoli di carta igienica**  
(max ø 21,5 x 1 cm)

Rollpaper dispenser

Distributeur papier à rouleau

Rollenpapierspender - Dispensador rollos de papel

Ёмкость для туалетной бумаги

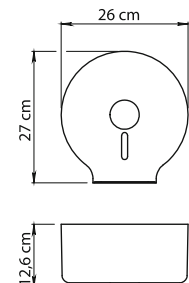

02  
Bianco  
White



11  
Azzurro  
Light blue



Serratura  
di sicurezza  
Safety lock

2252

Compatibile  
Compatible

## 2441.

GEDY

**Distributore per rotoli di carta igienica**  
(max ø 19 x 10 cm)

Rollpaper dispenser

Distributeur papier à rouleau

Rollenpapierspender - Dispensador rollos de papel

Ёмкость для туалетной бумаги

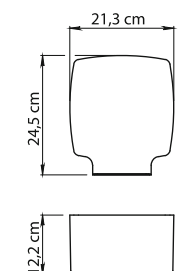

85  
Antracite  
Anthracite

2252

Compatibile  
Compatible

## A624 Maldive.

TOP DESIGN

### Portarotolo

Toilet paper holder  
Porte rouleau  
Papierrollenhalter  
Portarrollos  
Бумагодержатель

### Ottone e Cromall®

brass and Cromall®  
laiton et Cromall®  
Messing und Cromall®  
latón y Cromall®  
Нержавеющая латунь и Cromall®

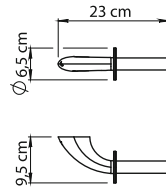

13  
**Cromato**  
Chromed



**15**  
YEARS  
GARANZIA  
WARRANTY

## 2839.

RETAIL

### Portarotolo singolo coperto con piano d'appoggio

Single covered roll holder with support surface  
Porte-rouleau papier toilette avec couvercle  
et support de rangement  
Einzelrollenhalter mit Abdeckung und Auflagefläche  
Portarrollos individual cubierto con superficie de apoyo  
Одинарный держатель туалетной бумаги  
закрытого типа с опорной поверхностью

### Acciaio inox AISI 304 e Cromall®

Stainless steel AISI 304 and Cromall®  
Acier inoxydable AISI 304 et Cromall®  
Edelstahl AISI 304 und Cromall®  
Acero inox AISI 304 y Cromall®  
Нержавеющая сталь AISI 304 и Cromall®

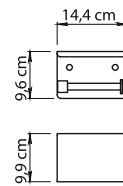

13  
**Cromato**  
Chromed



14  
**Nero matt**  
Matt black



**15**  
YEARS  
GARANZIA  
WARRANTY

## 2339.

GEDY

### Portarotolo doppio coperto con piano d'appoggio

Double toilet paper holder with support stand  
Porte rouleau papier WC couvert  
Doppelte Rollenhalterung, abgedeckt durch Auflagefläche  
Portarrollos doble cubierto con superficie de apoyo  
Стойка с двойным закрытым держателем рулона

### Acciaio inox AISI 304

Stainless steel AISI 304  
Acier inoxydable AISI 304  
Edelstahl AISI 304  
Acero inox AISI 304  
Нержавеющая сталь AISI 304

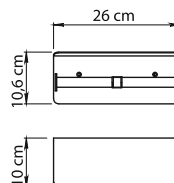

13  
**Lucido**  
Polished



**15**  
YEARS  
GARANZIA  
WARRANTY

## 2039.

GEDY

### Portarotolo singolo coperto con piano d'appoggio

Single covered roll holder with support surface  
 Porte-rouleau papier toilette avec couvercle et support de rangement  
 Einzelrollenhalter mit Abdeckung und Auflagefläche  
 Portarrollos individual cubierto con superficie de apoyo  
 Одинарный держатель туалетной бумаги закрытого типа с опорной поверхностью

### Acciaio inox e Cromall®

Stainless steel and Cromall®  
 Acier inoxydable et Cromall®  
 Edelstahl und Cromall®  
 Acero inox y Cromall®  
 Нержавеющая сталь и Cromall®



02  
Bianco  
White



13  
Cromato  
Chromed



14  
Nero matt  
Matt black

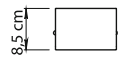
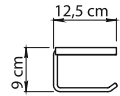

GARANZIA  
WARRANTY

## 2225 Sparrow.

GEDY

### Portarotolo coperto

Paper holder with cover  
 Porte rouleau avec couvercle  
 Papierrollenhalter mit Deckel  
 Portarrollo con tapa  
 Бумагодержатель с крышкой

### Acciaio inox e Cromall®

Stainless steel and Cromall®  
 Acier inoxydable et Cromall®  
 Edelstahl und Cromall®  
 Acero inox y Cromall®  
 Нержавеющая сталь и Cromall®



Con colla  
With glue

Venduta a parte  
Sold separately



Con viti  
With screws



Gira la placca  
come vuoi  
Turn the plate



13  
Cromato  
Chromed

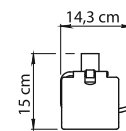

GARANZIA  
WARRANTY

## 2308.

GEDY

### Porta fazzoletti (max 24,5 x 12,5 cm)

Tissue box - Boîte à mouchoirs - Tücherbehälter  
 Porta pañuelos - Ёмкость для салфеток

### Acciaio inox AISI 304

Stainless steel AISI 304  
 Acier inoxidable AISI 304  
 Edelstahl AISI 304  
 Acero inox AISI 304  
 Нержавеющая сталь AISI 304



13  
Lucido  
Polished



38  
Spazzolato  
Brushed



2251  
2251/01  
Compatibile  
Compatible

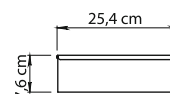

GARANZIA  
WARRANTY

Distributori di carta - Paper dispensers.

**2002.**

GEDY

**Porta fazzoletti**

Tissue box - Boîte à mouchoirs - Tücherbehälter  
Porta pañuelos - Ёмкость для салфеток

**Acciaio inox AISI 304**

Stainless steel AISI 304 - Acier inoxydable AISI 304  
Edelstahl AISI 304 - Acero inox AISI 304  
Нержавеющая сталь AISI 304

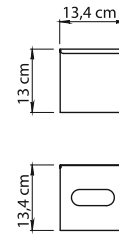

**2008.**

GEDY

100% MADE  
in Italy



**design Makio Hasuike**

**Porta fazzoletti**

Tissue box - Boîte à mouchoirs  
Tücherbehälter - Porta pañuelos  
Ёмкость для салфеток

**Resine termoplastiche**

Thermoplastic resins - Résine thermoplastique  
Kunststoff - Resinas termoplásticas  
Термопластичные смолы

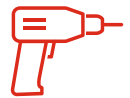
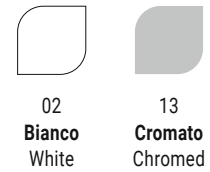
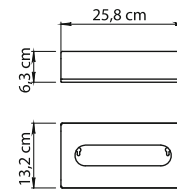

Con viti  
With screws

**2330.**

GEDY

**Porta sacchetti igienici**

Holder for sanitary towel bags  
Porte-sachets hygiéniques  
Behälter für Hygienebeutel  
Porta-bolsitas higiénicas  
Урна для гигиенических прокладок

**Acciaio inox AISI 304**

Stainless steel AISI 304 - Acier inoxydable AISI 304  
Edelstahl AISI 304 - Acero inox AISI 304  
Нержавеющая сталь AISI 304

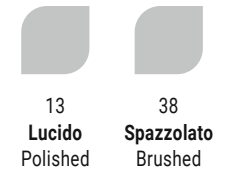
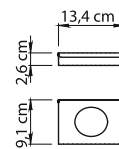

**2430.**

GEDY

100% MADE  
in Italy

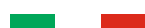

**Porta sacchetti igienici**

Holder for sanitary towel bags  
Porte-sachets hygiéniques  
Behälter für Hygienebeutel  
Porta-bolsitas higiénicas  
Урна для гигиенических прокладок

**Resine termoplastiche**

Thermoplastic resins - Résine thermoplastique  
Kunststoff - Resinas termoplásticas - Термопластичные смолы

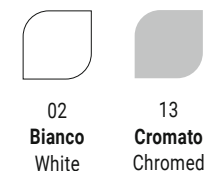
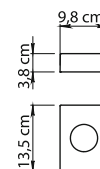

Con viti  
With screws



Con biadesivo  
With double sided tape

CONTRACT.

## Materiale di consumo

Refills - Pièces de recharge - Nachfüllungsteile  
Piezas de recarga - Заполнение

**Aloe.**

GEDY

100% MADE  
in Italy



Prodotto riciclato  
Recycled product

**2251.**



21 x 11 x 8 cm - 21 x 8 (1pz/pcs)

conf. da 150 pz.

box of 150 pcs - confection de 150 pièces - Box von 150 St.  
confección de 150 piezas - коробка 150 уастей

**2251-01.**



21 x 11 x 16 cm - 21 x 8 (1pz/pcs)

conf. da 300 pz.

box of 300 pcs - confection de 300 pièces - Box von 300 St.  
confección de 300 piezas - коробка 300 уастей

### Salviette in carta ecologica riciclata piegate a Z

Serviettes écologiques en papier recyclé plié en Z - Servietten mit Z-Falz aus umweltfreundlichem Recyclingpapier  
Toallitas de papel ecológico reciclado intercaladas - Ανακυκλωμένα οικολογικά μαντηλάκια τυλιγμένα σε Z

**2252.**



ø 19 x 18 cm - ø 19 x 9 (1 pz/pcs) - mt 150 cad./each

conf. da 150 pz.

box of 150 pcs - confection de 150 pièces - Box von 150 St.  
confección de 150 piezas - коробка 150 уастей

**2253.**



ø 26,5 x 18 cm - ø 26,5 x 9 (1 pz/pcs) - mt 300 cad./each

conf. da 300 pz.

box of 300 pcs - confection de 300 pièces - Box von 300 St.  
confección de 300 piezas - коробка 300 уастей

### Carta igienica in carta ecologica riciclata - confezione da 2 rotoli

Papier toilette écologique recyclé - Colis de 2 rouleaux - Toilettenpapier aus umweltfreundlichem Recyclingpapier Packung mit 2 Rollen - Papel higiénico de papel ecológico reciclado - paquete de 2 rollos - Туалетная бумага из рециклированной экологичной бумаги - в упаковке 2 рулона

**2254.**

### Carta asciugamani a spirale in carta ecologica riciclata - confezione da 2 rotoli

Essuie-mains en papier écologique recyclé à dévidage en spirale - Colis de 2 bobines  
Handtuchrollen mit Innenabzug aus umweltfreundlichem Recyclingpapier  
Packung mit 2 Rollen - Toalla de papel en rollo de papel ecológico reciclado - paquete de 2 rollos - Полотенца спиральной навивки из рециклированной экологичной бумаги - в упаковке 2 рулона



26 x 12,5 x 19 cm - ø 12,5 x 19 (1 pz/pcs)  
mt 68 cad./each

## Filo stendibiancheria riavvolgibile

Retractable clothes line - Sèche linge retractable  
 Aufrollbarer Wäschetrockner - Tendedero enrollable ocultador  
 Выдвижная нить для сушки белья

### 2450 Tullo.

GEDY

#### Acciaio inox

Stainless steel  
 Acier inoxydable  
 Edelstahl  
 Acero inox  
 Нержавеющая сталь

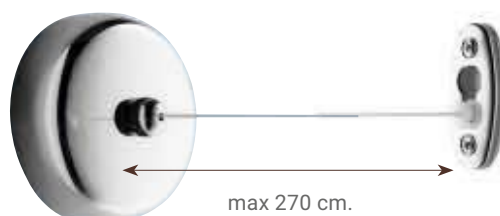

max 270 cm.

ø 9,3 x H5,5 cm



13  
**Lucido**  
 Polished



**Estensibile**  
 Extensible

## Mensole porta asciugamani

Shelves for towels - Etagères porte serviette - Handtuchablage  
 Estantes para toallas - Держатель полотенца

### 3235 Outline.

TOP DESIGN

design Simone Micheli

#### Acciaio inox, ottone e Cromall®

Stainless steel, brass and Cromall®  
 Acier inoxydable, laiton et Cromall®  
 Edelstahl, Messing und Cromall®  
 Acero inox, latón y Cromall®  
 Нержавеющая сталь,  
 латунь и Cromall®

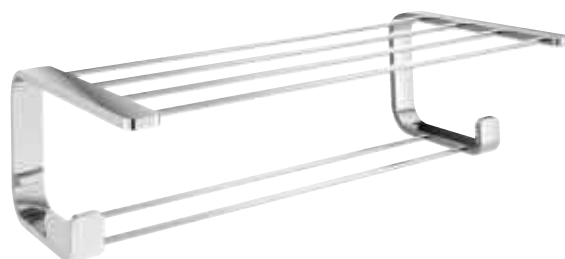

15  
 YEARS

GARANZIA  
 WARRANTY

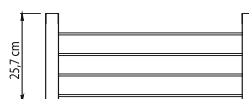
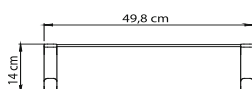

13  
**Cromato**  
 Chromed



14  
**Nero matt**  
 Matt black



22  
**Bianco matt**  
 Matt white

### A235 Canarie.

TOP DESIGN

#### Ottone e Cromall®

Brass and Cromall®  
 Laiton et Cromall®  
 Messing und Cromall®  
 Latón y Cromall®  
 Латунь и Cromall®



15  
 YEARS

GARANZIA  
 WARRANTY

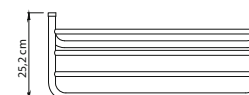
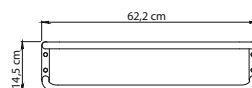

13  
**Cromato**  
 Chromed

CONTRACT.

## Febo.

RETAIL

### Acciaio inox e Cromall®

Stainless steel and Cromall®  
Acier inoxidable et Cromall®  
Edelstahl und Cromall®  
Acero inox y Cromall®  
Нержавеющая сталь  
и Cromall®

10  
YEARS

GARANZIA  
WARRANTY



13  
Cromato  
Chromed

5335

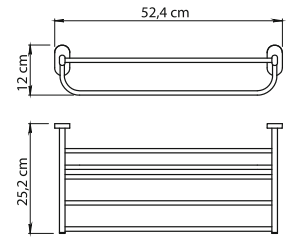

5344

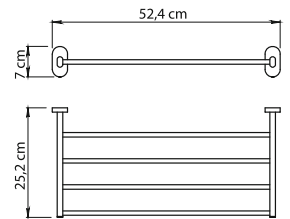
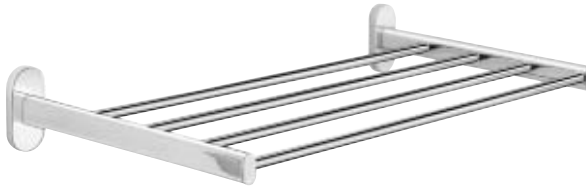

## Project.

GEDY

### Acciaio inox AISI 304

Stainless steel AISI 304  
Acier inoxidable AISI 304  
Edelstahl AISI 304  
Acero inox AISI 304  
Нержавеющая сталь AISI 304

100%  
AISI  
304

15  
YEARS

GARANZIA  
WARRANTY



13  
Lucido  
Polished

5035

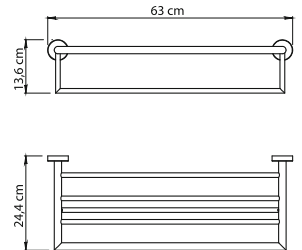

5044

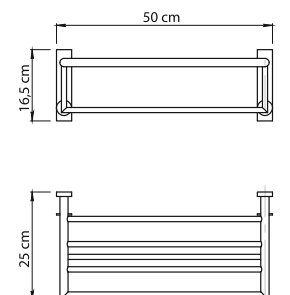

NEW



13  
Lucido  
Polished



38  
Spazzolato  
Brushed



**Ascot.**

GEDY

design Carlo Vietri

**Acciaio inox e Cromall®**

Stainless steel and Cromall®

Acier inoxydable et Cromall®

Edelstahl und Cromall®

Acero inox y Cromall®

Нержавеющая сталь

и Cromall®

2435

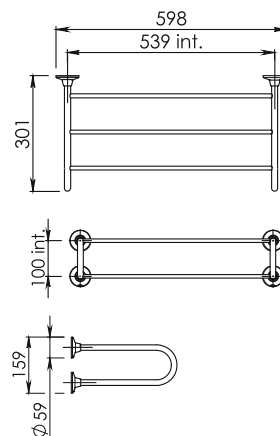
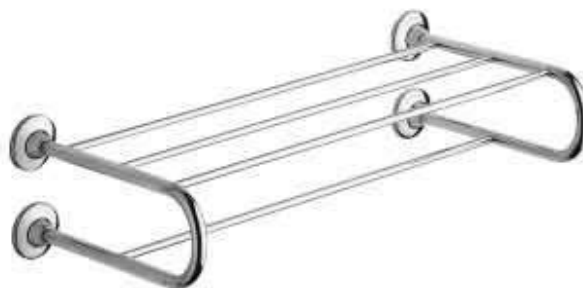

2735

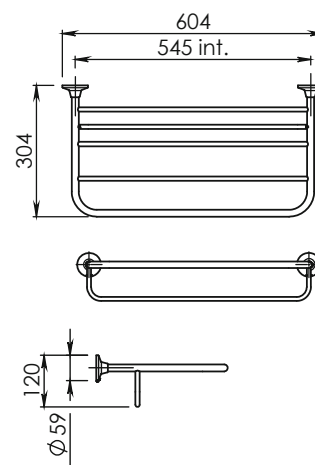
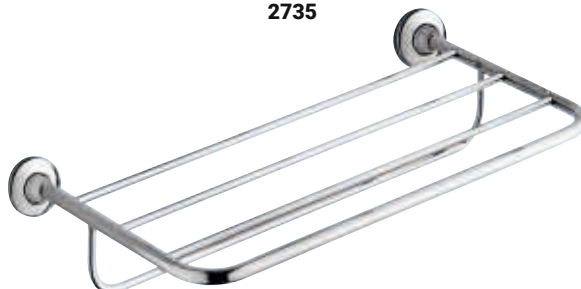

2744

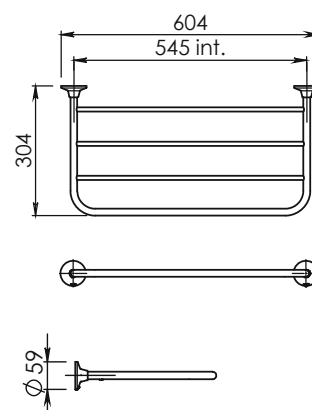

13

**Cromato**  
Chromed

## Edera.

GEDY

**Acciaio inox e Cromall®**  
 Stainless steel and Cromall®  
 Acier inoxydable et Cromall®  
 Edelstahl und Cromall®  
 Acero inox y Cromall®  
 Нержавеющая сталь  
 и Cromall®

ED35

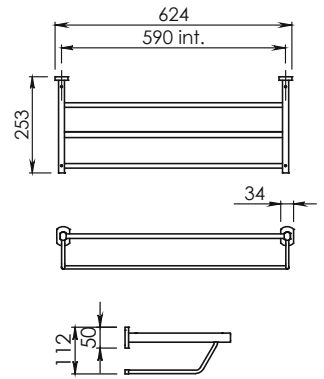

ED44

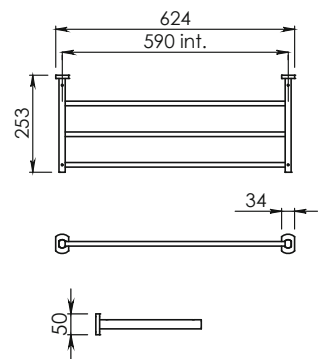

13  
**Cromato**  
 Chromed

## Felce.

GEDY

**Acciaio e Cromall®**  
 Steel and Cromall®  
 Acier et Cromall®  
 Stahl und Cromall®  
 Acero y Cromall®  
 Сталь и Cromall®

FE35

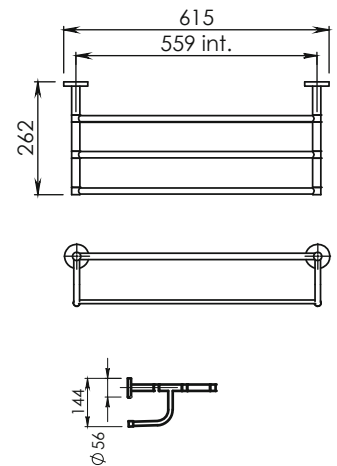

FE44

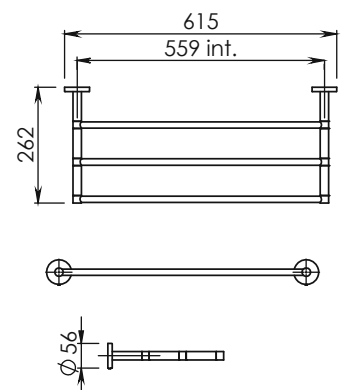

13  
**Cromato**  
 Chromed

Mensole porta asciugamani - Shelves for towels.

## Maniglioni

Grab bar - Barre d'appui - Wannengriff- Asideros - Поручень



### A621-50 Maldive.

TOP DESIGN

#### Cromall® e ottone

Cromall® and brass

Cromall® et laiton

Cromall® und Messing

Cromall® y latón

Cromall® и латунные



13  
Cromato  
Chromed



15  
YEARS

GARANZIA  
WARRANTY

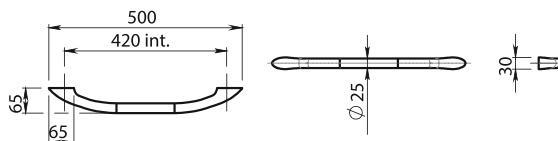

CONTRACT.

Canarie.

TOP DESIGN

Cromall® e ottone

Cromall® and brass  
 Cromall® et laiton  
 Cromall® und Messing  
 Cromall® y latón  
 Cromall® и латунные



A221-28

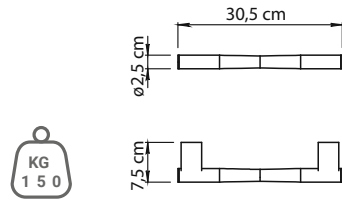

13  
**Cromato**  
 Chromed



GARANZIA  
 WARRANTY



A222

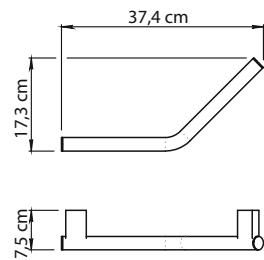

Outline.

TOP DESIGN

design Simone Micheli

Cromall® e ottone

Cromall® and brass  
 Cromall® et laiton  
 Cromall® und Messing  
 Cromall® y latón  
 Cromall® и латунные



3221-25



13 **Cromato** Chromed  
 14 **Nero matt** Matt black  
 22 **Bianco matt** Matt white

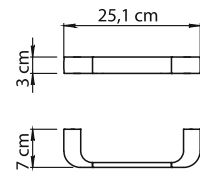

3221-35

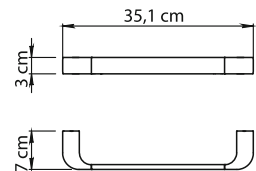

3221-55

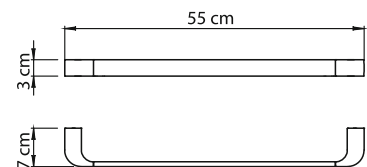

GARANZIA  
 WARRANTY



## Project.

GEDY

### Acciaio inox AISI 304

304 AISI stainless steel

Acier inox AISI 304

Edelstahl AISI 304

Acero inox AISI 304

Сталь AISI 304

CONFORME  
IN CONFORMITY WITH  
UNI11064:2003

15  
YEARS

GARANZIA  
WARRANTY

100%  
AISI  
304

KG  
160



Reversibile  
Reversible



13  
Lucido  
Polished



38  
Spazzolato  
Brushed



5022

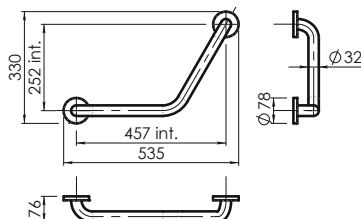

KG  
180

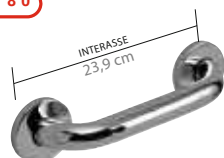

5021-24

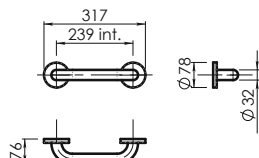

KG  
160

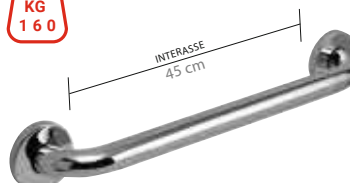

5020-45

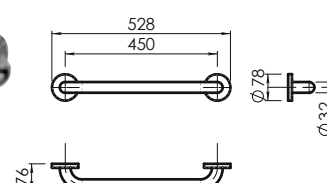

## Ascot.

GEDY

design Carlo Vietri

### Acciaio inox AISI 304, alluminio e Cromall®

Stainless steel AISI 304, aluminum and Cromall®

Acier inoxydable AISI 304, aluminium et Cromall®

Edelstahl AISI 304, Aluminium und Cromall®

Acero inox AISI 304, aluminio y Cromall®

Нержавеющая сталь AISI 304, алюминия и Cromall®

AISI  
304



Reversibile  
Reversible

KG  
127

10  
YEARS

GARANZIA  
WARRANTY



13  
Cromato  
Chromed



2720

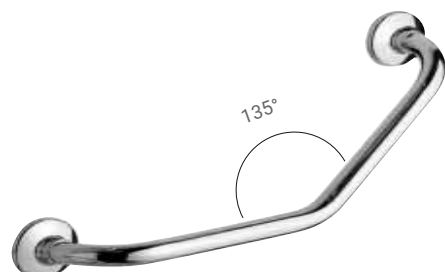
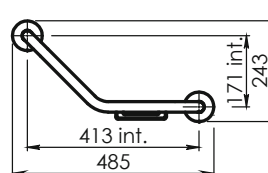
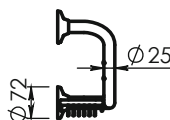

2722

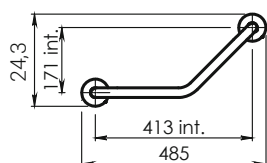

con portasapone in filo reversibile in acciaio inox  
with reversible wire soap holder in stainless steel  
avec porte savon fil réversible en acier inoxydable  
mit umkehrbarer Stabseifenschale aus Edelstahl  
con jabonera de varillas movil en acero inox  
с мыльницей с проволочным основанием ие нержавеющей стали

**Edera.**

GEDY

**Acciaio inox AISI 304 e Cromall®**

Stainless steel AISI 304 and Cromall®  
 Acier inoxydable AISI 304 et Cromall®  
 Edelstahl AISI 304 und Cromall®  
 Acero inox AISI 304 y Cromall®  
 Нержавеющая сталь AISI 304 и Cromall®



GARANZIA  
WARRANTY



13  
Cromato  
Chromed



ED21/28

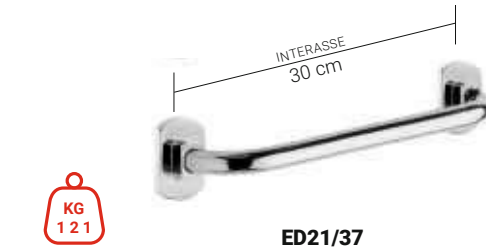
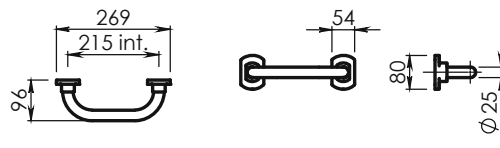

ED21/37

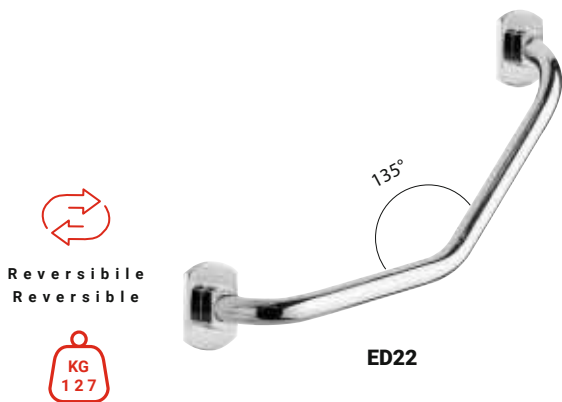
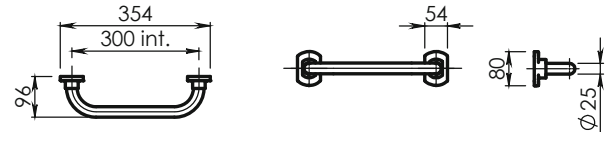

ED22

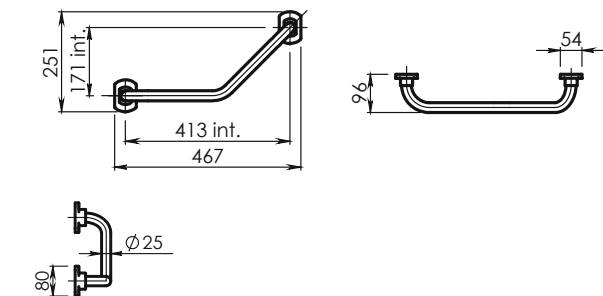

ED20

**Acciaio inox AISI 304, alluminio e Cromall®**

Stainless steel AISI 304, aluminum and Cromall®  
 Acier inoxydable AISI 304, aluminium et Cromall®  
 Edelstahl AISI 304, Aluminium und Cromall®  
 Acero inox AISI 304, aluminio y Cromall®  
 Нержавеющая сталь AISI 304, алюминия и Cromall®

**con portasapone in filo reversibile in acciaio inox**

with reversible wire soap holder in stainless steel  
 avec porte savon fil réversible en acier inoxydable  
 mit umkehrbarer Stabseifenschale aus Edelstahl  
 con jabonera de varillas móvil en acero inox  
 с мыльницей с проволочным основанием ие нержавеющей стали

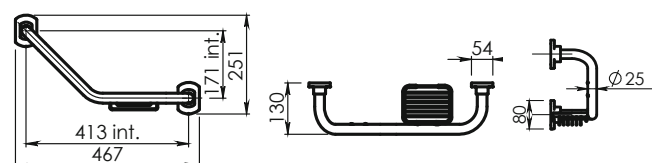

Maniglioni - Grab bars.

Up.

CONFORME - IN CONFORMITY WITH UNI11064:2003

GEDY

Acciaio inox

Stainless steel - Acier inox - Edelstahl - Acero inox - Сталь

10 YEARS

GARANZIA WARRANTY



02 Bianco White



14 Nero matt Matt black



13 Cromato Chromed

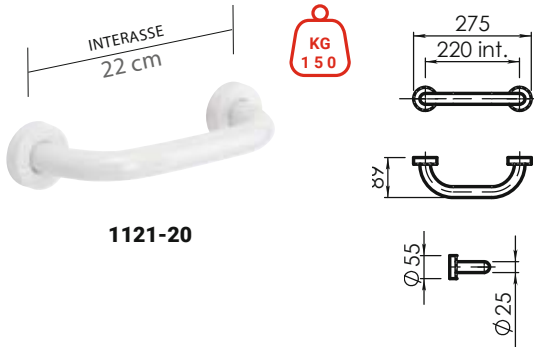

1121-20



1121-30



1121-45

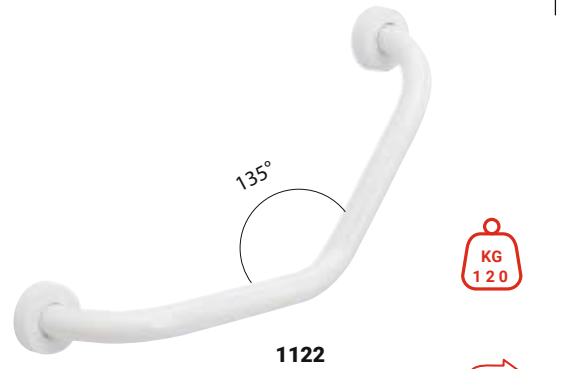

1122



Reversible Reversible

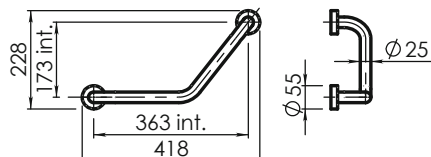
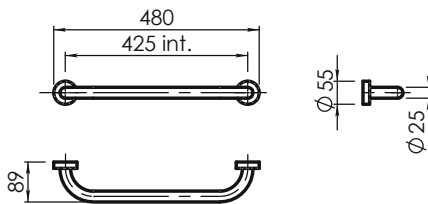

5657 Snug.

NEW

GEDY

Acciaio inox AISI 304

304 AISI stainless steel - Acier inox AISI 304

Edelstahl AISI 304 - Acero inox AISI 304 - Сталь AISI 304

100% AISI 304

10 YEARS

GARANZIA WARRANTY



13 Cromato Chromed



14 Nero matt Matt black



38 Spazzolato Brushed

Meccanismo di ribaltamento in posizione orizzontale e verticale  
 Collapsible mechanism in horizontal and vertical position  
 Mécanisme de basculement en position horizontale et verticale  
 Kippmechanismus in waagerechter und in senkrechter Position  
 Mecanismo de abatimiento en posición horizontal y vertical  
 Откидной механизм в вертикальном и горизонтальном положении



KG 150

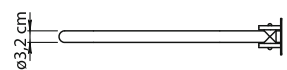
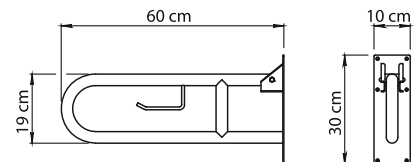

CONTRACT.

GEDY

## Project.

### Realizzata in acciaio inox AISI 304 con contenitori in vetro satinato

Made of AISI 304 stainless steel with frosted glass containers

Réalisée en acier inoxydable AISI 304 avec boîtiers en verre satiné

Hergestellt aus Edelstahl AISI 304 mit Behältern aus satiniertem Glas

Realizada en acero inox AISI 304 con contenedores en cristal satinado

Изготовлено из нержавеющей стали AISI 304 с ёмкостями из матового стекла

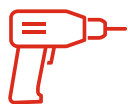

Con viti

With screws



GARANZIA

WARRANTY



13

Lucido  
Polished



38

Spazzolato  
Brushed



Project.



CONTRACT

**GEDY**



CONFORME / IN CONFORMITY WITH UNI11064:2003

**K G 180**

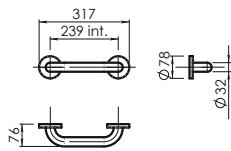

**5020-24**

**K G 160**

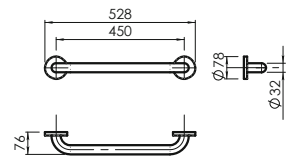

**5020-45**

**K G 160**



Reversible  
Reversible

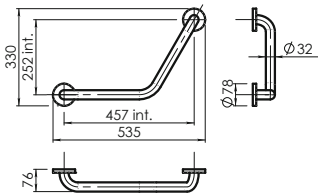

**5022**

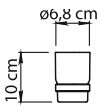

**5010**

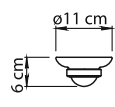

**5011**

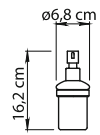

**5081**

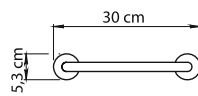

**5021-30**

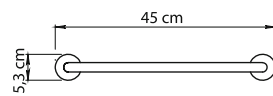

**5021-45**

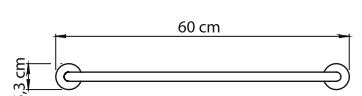

**5021-60**

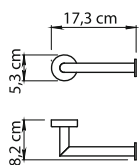

5024

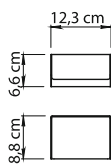

5025

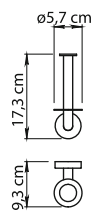

5024-02

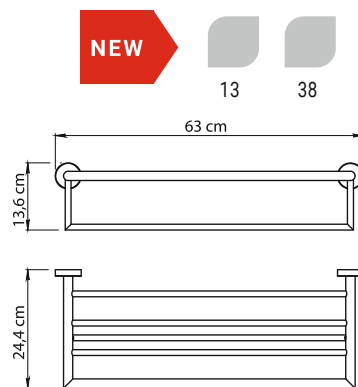

5044

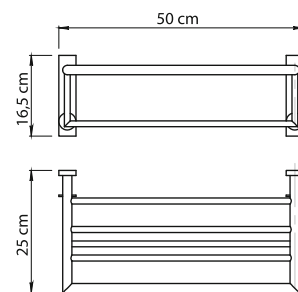

5035

13  
solo - only

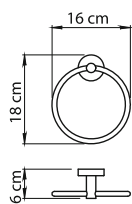

5070

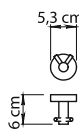

5026

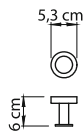

5027

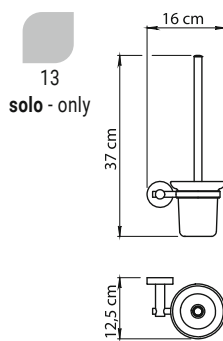

5033-03

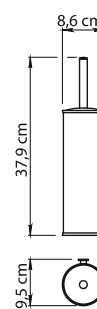

5034-03



5034

NEW

13 38

## PRIMA CLASSE

## Programma in acciaio inox e nylon

Program made of stainless steel and nylon

Programme en acier inoxydable et nylon

Programm aus Edelstahl und Nylon - Programa en acero inox y nylon

Программа из нержавеющей стали и нилон



13

Cromato  
Chromed

Ø 32 mm

100% MADE  
in Italy

Massima funzionalità, materiali di alta qualità e un sistema modulare: questo il programma PRIMA CLASSE. Il sistema di maniglioni è realizzato in acciaio inox in finitura lucida e completato con il maniglione di sostegno e l'appoggio ribaltabile, con o senza portarotolo, dalla forma moderna e chic.

Absolute functionality, high-quality materials and modular construction system: those are the outstanding characteristics of the PRIMA CLASSE program of safety grab bars. The handles are made of stainless steel in polished finishing and rounded off by the folding and support handle, with or without paper holder, in a modern and elegant design.

Absolute Funktionalität, hochwertige Materialien und modulares Baukastensystem: diese sind die herausragenden Merkmale des Sitz- und Griffsystems PRIMA CLASSE. Das Griffsystem besteht aus poliertem Edelstahl und abgerundet wird dieses Programm durch den Klapp- und Stützgriff, mit oder ohne Papierrollenhalter, mit einer modernen eleganten Form.

Materiales de alta calidad, funcionalidad absoluta y modularidad: este el programa de asientos y de asideros de seguridad PRIMA CLASSE. El programa de asideros es realizado en acero inoxidable en acabado brillo y es completado por el asidero móvil, con o sin portarrollo y el asidero de apoyo, de forma moderna y elegante.

Une extrême fonctionnalité, des matériaux de haute qualité et un système modulaire: c'est la collection PRIMA CLASSE. Le système de barres est réalisé en acier inoxydable avec finition polie et complété par la barre d'appui et par la barre à abattant, avec ou sans porte papier, de forme moderne et chic.

Максимальная функциональность, высококачественные материалы и модульная система - все это программа "ПЕРВЫЙ КЛАСС". Система ручек изготовлена из нержавеющей стали с блестящей отделкой, дополнена поручнем и откидной ручкой с держателем для туалетной бумаги или без него в современном и шикарном стиле.



## 6008.

### Specchio basculante infrangibile in acciaio inox AISI 304

Shatterproof tilting mirror  
in AISI 304 stainless steel  
Miroir basculant infrangible  
en acier inox AISI 304  
Neigbarer bruchsicherer Spiegel  
aus Edelstahl AISI 304  
Espejo basculante irrompible  
de acero inoxidable AISI 304  
Поворотное зеркало небьющееся  
из нержавеющей стали AISI 304



13  
Super  
Mirror

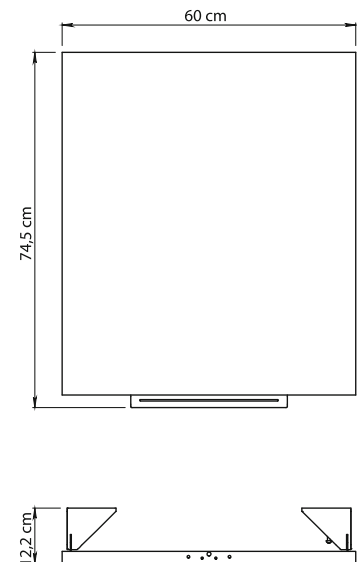

GARANZIA  
WARRANTY

## 6046.

### Sostegno per doccia con saliscendi

Shower support with sliding rail  
Barre pour douche avec système  
de fixation ajustable  
Duschstangenhalterung  
Soporte para ducha con columna  
Штанга для душа

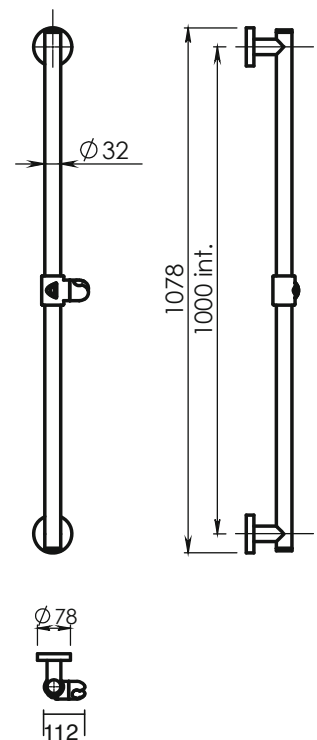

## 6047.



08  
Grigio  
Grey

L6,5 x P5 x H10 cm

### Saliscendi - ABS

Shower support - ABS  
Fixation douche ajustable - ABS  
Duschhalterung - ABS  
Soporte para ducha - ABS  
Подвижный держатель для душа - ABS

CONTRACT.

**6021-25.**

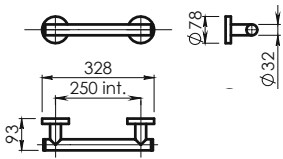

**6021-45.**

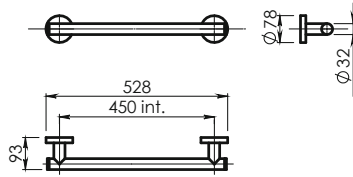

**6021-55.**

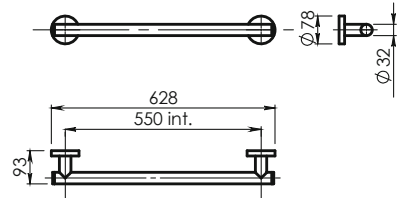

**6021-65.**

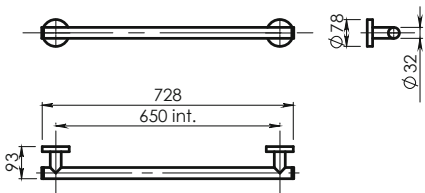

**6043-10.**

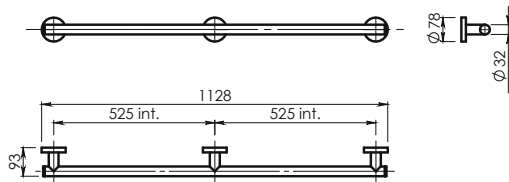

**6090-44.**

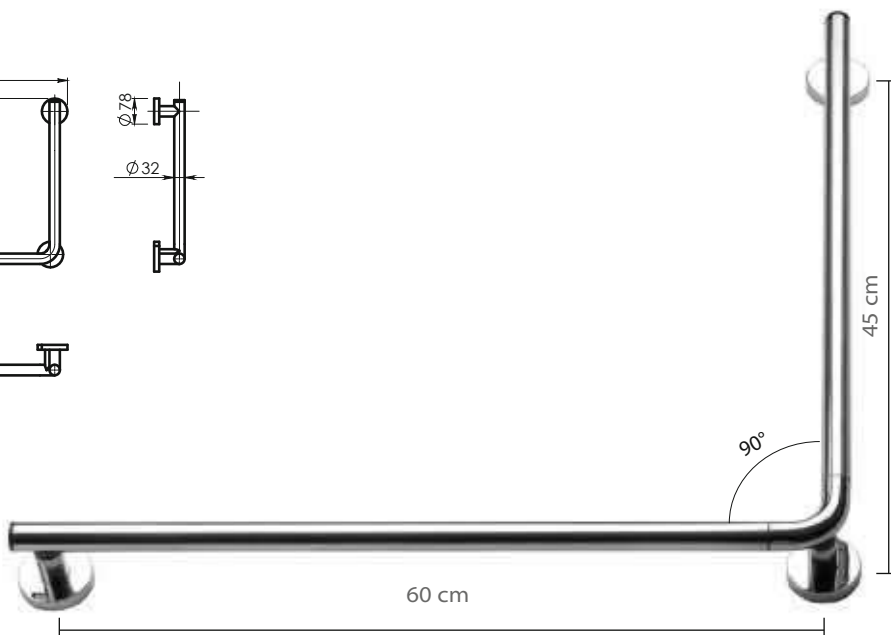
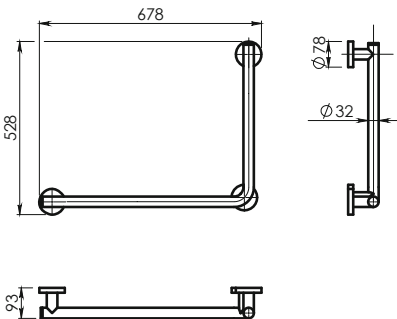

Reversible  
Reversible

**Appoggio ribaltabile**

Safety folding handle - Barre à abattant  
 Klappgriff - Soporte móvil - Мобильный поручень

design Studio Talocci Design

**6057-65.\***

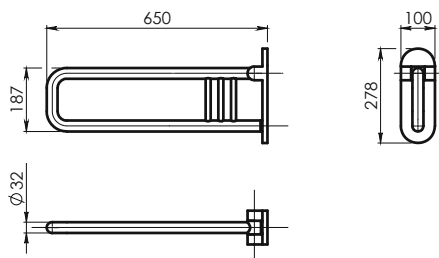

**6057-75.\***

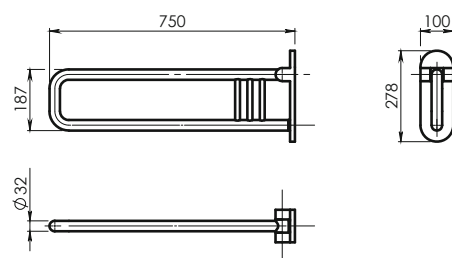

**con portarotolo**

with paper holder - avec porte rouleau  
 mit Papierrollenhalter - con portarollo  
 с бумагодержателям

**6058-65.\***

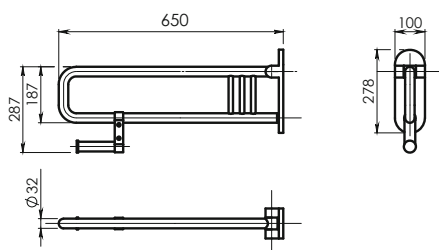

**6058-75.\***

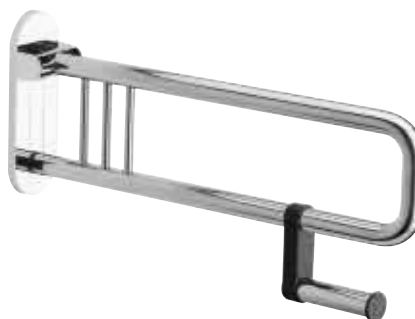
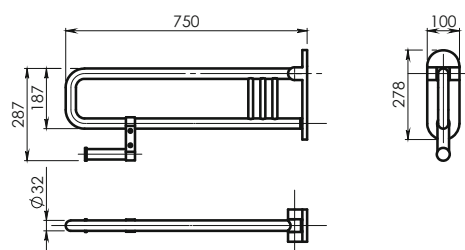

\* Meccanismo di ribaltamento in posizione orizzontale e verticale - Collapsible mechanism in horizontal and vertical position - Mécanisme de basculement en position horizontale et verticale - Kippmechanismus in waagerechter und in senkrechter Position - Mecanismo de abatimiento en posición horizontal y vertical - Откидной механизм в вертикальном и горизонтальном положениях

**6059-65.**

**Appoggio**

Safety handle - Support - Wandstützgriff  
 Soporte - Обратимый

design Studio Talocci Design

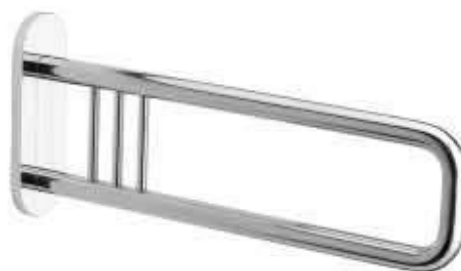
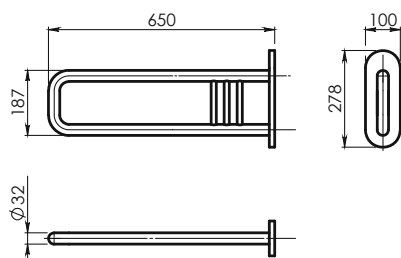

CONTRACT.

6082.



Movimento soft  
Soft moving



02  
Bianco  
White



85  
Antracite  
Anthracite

design Studio Talocci Design

**Sedile ribaltabile per doccia**

Shower seat

Siège pour douche repliable

Duschsitz hochklappbar

Asiento móvil para ducha

Сиденье для душа

**Alluminio e ABS**

Aluminium and ABS

Aluminium et ABS

Aluminium und ABS

Aluminio y ABS

Алюминий и ABS

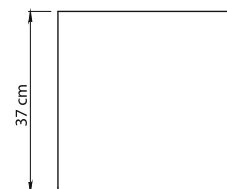
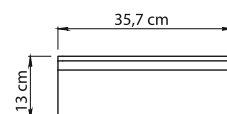

6073.

design  
Studio Talocci Design & Pallocca

**Sgabello**

Stool

Tabouret

Hoher

Taburete

Табурет

**Alluminio e ABS**

Aluminium and ABS

Aluminium et ABS

Aluminium und ABS

Aluminio y ABS

Алюминий и ABS



02  
Bianco  
White



85  
Antracite  
Anthracite

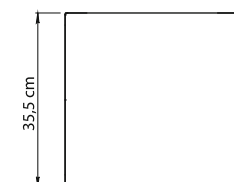
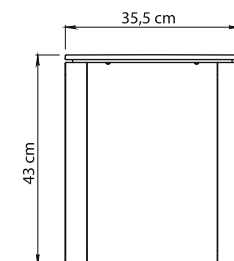



6083.



Movimento soft  
Soft moving



02  
Bianco  
White



23  
Bianco/Cromo  
White/Chromed



43  
Antracite/Cromo  
Anthracite/Chromed

design Studio Talocci Design

**Sedile ribaltabile per doccia**

Shower seat

Siège pour douche repliable

Dushsitz hochklappbar

Asiento móvil para ducha

Сиденье для душа



— 4,8 —

**Alluminio e ABS**

Aluminium and ABS

Aluminium et ABS

Aluminium und ABS

Aluminio y ABS

Алюминий и ABS

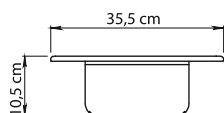
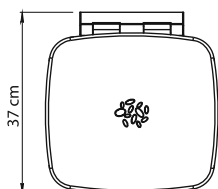

6072.



02  
Bianco  
White



23  
Bianco/Cromato  
White/Chromed



43  
Antracite/Cromato  
Anthracite/Chromed

design Studio Talocci Design

**Sgabello**

Stool

Tabouret

Hoher

Taburete

Табулет

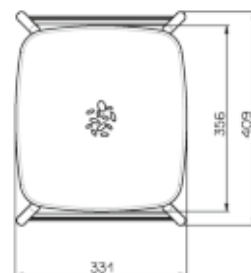
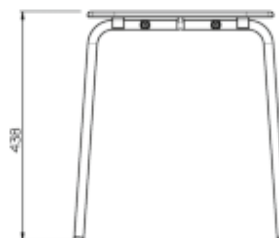

**Alluminio e ABS**

Aluminium and ABS

Aluminium et ABS

Aluminium und ABS

Aluminio y ABS

Алюминий и ABS

## SICURA

### Programma in alluminio e nylon

Program made of aluminium and nylon - Programme en aluminium et nylon

Programm aus Aluminium und Nylon - Programa en aluminio y nylon

Программа из алюминий и нейлон



02  
Bianco  
White

Ø 32 mm

★ **Articolo disponibile su richiesta** - Item available on request  
Article disponible sur demande - Auf Anfrage erhältlich Artikel  
Artículo disponible bajo petición - Продукция, изготавливаемая по заказу



100% MADE  
in Italy



Un vastissimo programma di maniglioni e sistemi d'appoggio fissi e mobili in grado di soddisfare tutte le esigenze. Il sistema Sicura, offre sicurezza e libertà dalle barriere architettoniche. Copertura trattata con polveri speciali in resine epossidiche e poliestere, antiurto, antigraffio e non attaccabile dalle sostanze disinfettanti.

A very wide range of handles and fixed and movable supporting systems which will satisfy any requirements. The Sicura system, offers safety and freedom from architectural barriers. Covering treated with special epoxy and polyester resins, shockproof, scratch-proof and resistant to attack by disinfectants.

Un très vaste éventail de poignées et de systèmes d'appui fixes et mobiles en mesure de satisfaire toutes les exigences. Le système Sicura,, permet de surmonter en toute sécurité et liberté les barrières architectoniques. Couverture traitée avec des poudres spéciales en résines époxy et polyester, antichoc, anti-égratignures et résistante aux substances désinfectantes.

Ein großes Angebot an Griffen, sowie festen und mobilen Stützsysteemen, die allen Ansprüchen entsprechen. Sicura System bietet Sicherheit und Unabhängigkeit von architektonischen Barrieren. Die mit Spezialpulver aus Epoxyd- und Polyesterharzen oberflächenbehandelte Serie aus Aluminium und Nylon ist schlagfest, kratzfest und

Un amplísimo programa de grilletes y de sistemas de apoyo fijos y de muebles capaces de satisfacer todas las exigencias. El sistema Sicura, ofrece seguridad y libertad de las barreras arquitectónicas. Revestimiento tratado con polvos especiales de resinas epoxídicas y poliéster, antichoque, irrayable y no atacable por las sustancias desinfectantes.

Предлагаем широкий ассортимент поручней и опорных приспособлений, как съёмных, так и стационарных, отвечающих самым разнообразным требованиям. Система Sicura, обеспечивает безопасность при отсутствии капитальных ограждений. При изготовлении используется алюминий и нейлон, а также покрытия, обработанные специальными эпоксидными и полиэфирными порошками, устойчивыми к механическим и химическим воздействиям.

### 4008.

#### Specchio basculante

Balancing mirror  
Miroir basculant  
Bewegbarer Spiegel  
Espejo basculante  
Вращающееся зеркало



GARANZIA  
WARRANTY

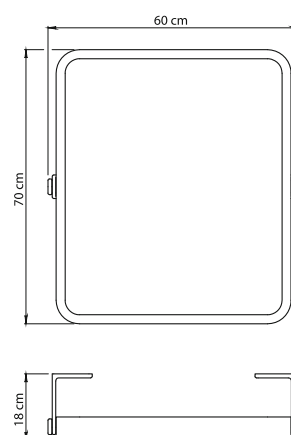

#### Resine termoplastiche e nylon

Thermoplastic resins and nylon  
Thermoplastique et nylon  
Kunststoff und nylon  
Resinas termoplásticas y nylon  
Термопластичных смол и нейлона

**Maniglioni antiscivolo, con superfici prive di angoli**

Non-slip handles, with smooth, rounded surfaces  
 Poignées antidérapantes, avec surfaces sans arêtes  
 Elemente mit rutschfesten Griffen und kantenlosen Oberflächen  
 Grilletes antideslizantes, con superficies sin ángulos  
 Нескользящие поручни с округлой поверхностью

**Fissaggio orizzontale e verticale**  
 Horizontal and vertical fixing

**4840-25.\***

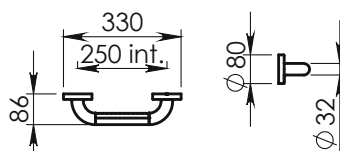

**4840-45.**

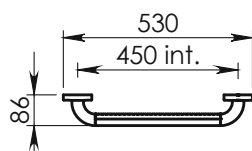

**4841-55.**

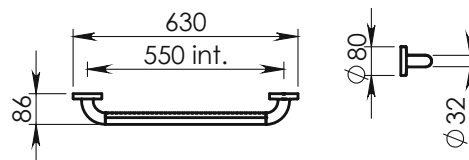

**4842-65.**

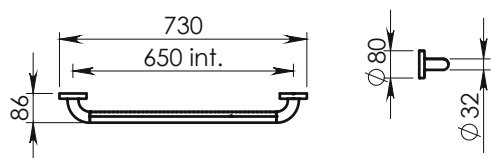

**Corrimano**

Wall handrail - Main courante - Wandhandlauf  
 Barandilla de pared - Угловой поручень для ванной комнаты

**4843-10.**

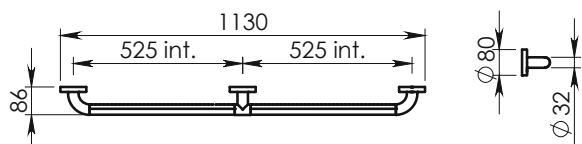

**4844-11.\***

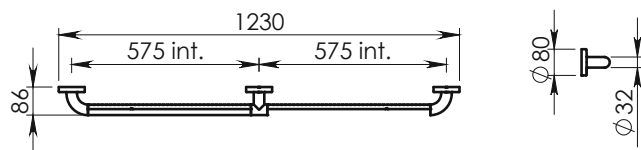

**Sostegno a 90°**

Holding handle 90° - Barre 90° - Wandhaltegriff 90°  
 Soporte de 90° - Настенный поручень под углом 90°

**4844-44.**

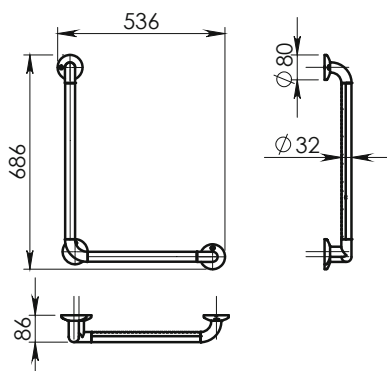

**4849-44.\***

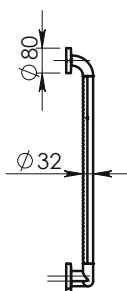
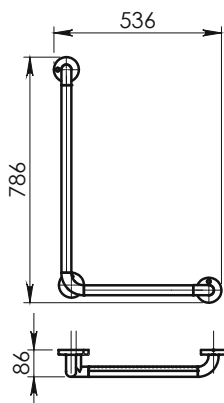

Reversibile  
 Reversible

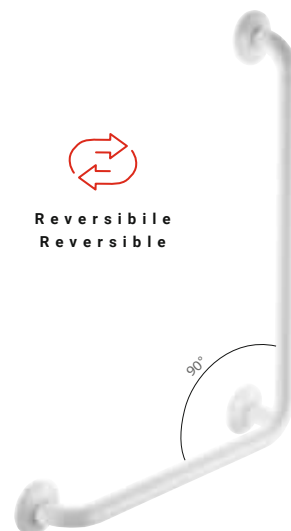

CONTRACT.

**4854-77.\***

**Sostegno a 90°**

Holding handle 90° - Barre 90° - Wandhaltegriff 90°  
 Soporte de 90° - Настенный поручень под углом 90°



Reversibile  
 Reversible

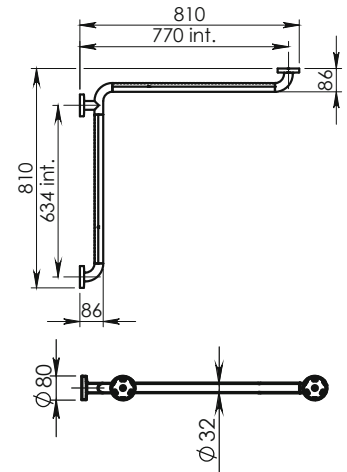

**4857-64.**

**Appoggio ribaltabile**

Safety folding handle - Barre à abattant  
 Klappgriff - Soporte móvil - Мобильный поручень

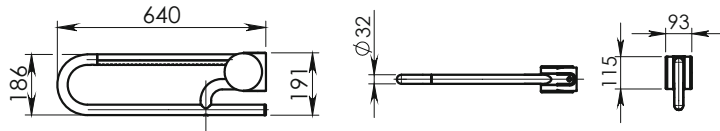

**4858-74.**

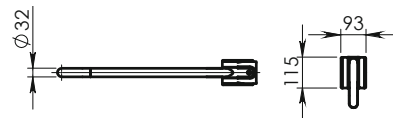
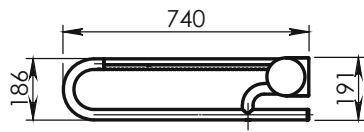

**Meccanismo di ribaltamento in posizione orizzontale e verticale**  
 Collapsible mechanism in horizontal and vertical position  
 Mécanisme de basculement en position horizontale et verticale  
 Kippmechanismus in waagerechter und in senkrechter Position  
 Mecanismo de abatimiento en posición horizontal y vertical  
 Откидной механизм в вертикальном и горизонтальном положении

**4859-64.**

**Appoggio reversibile**

Reversible safety handle - Support réversible - Wandstützgriff reversibile  
 Soporte reversible - Поручень обратимый

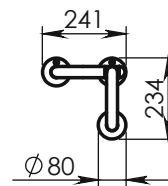
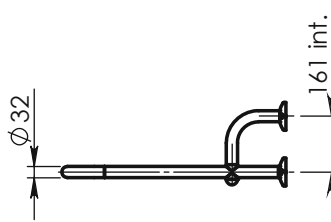
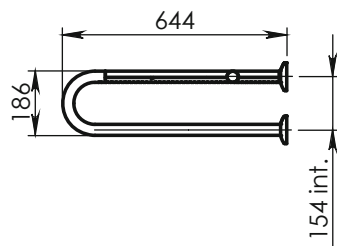

Reversibile  
 Reversible

**4863.\***

**Maniglione per vasca. Adattabile a vasche con bordo da 6 cm a 12,5 cm**

Safety handle for bath. Adaptable for bath-tubs with rims from 6 cm to 12,5 cm  
 Barre de sûreté pour baignoire. Adaptable à baignoires avec bord de 6 cm à 12,5 cm  
 Wanneneinsteighilfe. Verwendbar für Wannen mit einer Wandstärke von 6 cm bis 12,5 cm  
 Asidero para bañera.  
 Adaptable a bañeras con borde de 6 cm a 12,5 cm  
 Двойной поручень на ванну. Устанавливается на ванны, имеющие стенку от 6 до 12,5 см

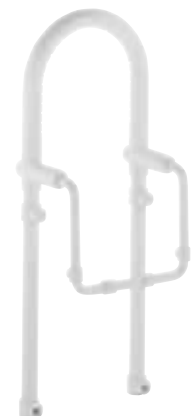
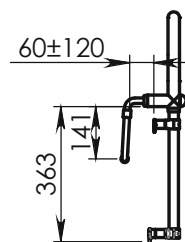
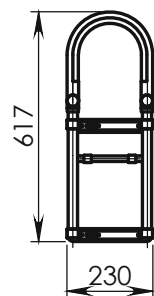

**2284.****Sedile estensibile per vasca**

Bath tub seat - Siège pour baignoire  
 Badewannensitz - Asiento para bañera  
 Раскладное сиденье для ванной

**Resine termoplastiche e alluminio**

Thermoplastic resins and aluminium  
 Thermoplastique et aluminium  
 Kunststoff und Aluminium  
 Resinas termoplásticas y aluminio  
 Термопластичных смол и алюминий

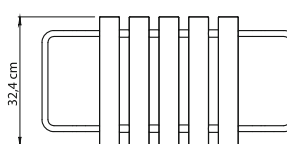
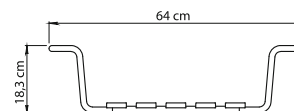

**Regolabile**  
**Adjustable**

**Braccioli estensibili per vasche con misura interna di 50-65 cm**

Extendable arms for baths with internal measurement 50-65 cm  
 Bras extensibles pour baignoires aux dimensions intérieures de 50-65 cm  
 Verlängerbare Armlehnen für Wannen mit einem Innenmaß von 50-65 cm  
 Ароуабразос extensibles para bañeras con medidas interiores de 50-65 cm  
 Выдвижные поручни для ванны, имеющей внутреннюю ширину от 50 до 65 см

**2283.****Sedile ribaltabile per doccia**

Shower seat - Siège pour douche repliable  
 Duschsitz hochklappbar - Asiento móvil para ducha  
 Сиденье для душа

**Resine termoplastiche e alluminio**

Thermoplastic resins and aluminium  
 Thermoplastique et aluminium  
 Kunststoff und Aluminium  
 Resinas termoplásticas y aluminio  
 Термопластичных смол и алюминий

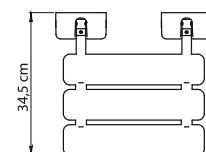
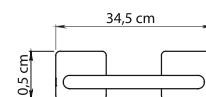
**4896.\*****Sedile con seduta liscia ergonomica agganciabile a maniglione**

Hanging smooth shower seat for grab bar system  
 Siège pour douche avec assise lisse, accrochable à barre d'appui  
 Einhängesitz für Grifffsystem mit glatter Sitzfläche  
 Asiento colgado para ducha con silla lisa ergonómica por el sistema de asideros  
 Сиденье с гладкой поверхностью, прицепляемое к рукоятке

**Resine termoplastiche e alluminio**

Thermoplastic resins and aluminium  
 Thermoplastique et aluminium - Kunststoff und Aluminium  
 Resinas termoplásticas y aluminio  
 Термопластичных смол и алюминий

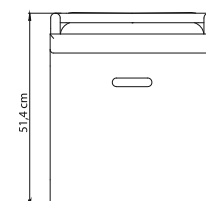
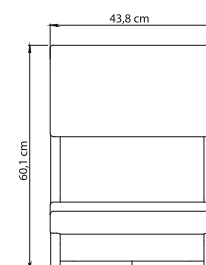

CONTRACT.



GARANZIA  
WARRANTY

## FORTIS



Ø 30 mm

02  
Bianco  
White



100% MADE  
in Italy



Programma di maniglioni e sistemi d'appoggio fissi e mobili realizzato in acciaio zincato con verniciatura con polveri speciali in resine epossidiche e poliestere e attacchi in Ultraform®.

Range of handles and fixed and movable supporting systems made of zincated steel with covering treated with special epoxy and polyester resins and wall plates in Ultraform®.

Programme de poignées et de systèmes d'appui fixes et mobiles, réalisé en acier zingué avec laquage traité avec des poudres spéciales en résines époxy et polyester et plaques à mur en Ultraform®.

Serie von Griffen, sowie festen und mobilen Stützsystemen, hergestellt aus mit Spezialpulver aus Epoxyd- und Polyesterharzen oberflächenbehandeltem verzinkten Stahl mit Wandbefestigungen aus Ultraform®.

Programa de grilletes y de sistemas de apoyo fijos y de muebles realizado en acero galvanizado con revestimiento tratado con polvos especiales de resinas epoxídicas y poliéster y placas de pared en Ultraform®.

Ассортимент поручней и опорных приспособлений, как съёмных, так и стационарных, изготовлено из оцинковыванной стали, а также покрытия, обработанные специальными эпоксидными и полиэфирными порошками и с плитами стены в Ultraform®.



**Maniglioni**

Grab bar - Barre d'appui - Wannengriff- Asideros - Поручень

**Fissaggio orizzontale e verticale**

Horizontal and vertical fixing

**6421-30.**

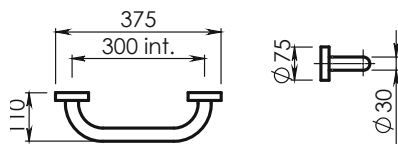

**6421-45.**

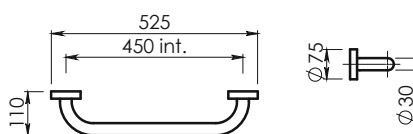

**6421-60.**

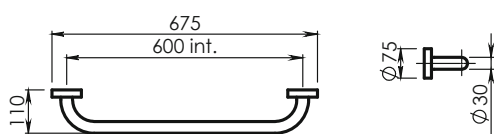

**6421-90.**

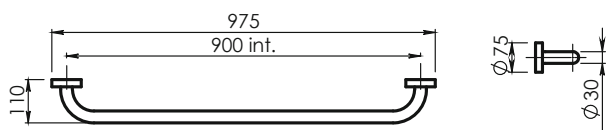

**Sostegno a 90°**

Holding handle 90° - Barre 90° - Wandhaltegriff 90°  
 Soporte de 90° - Настенный поручень под углом 90°

**6490-00.**

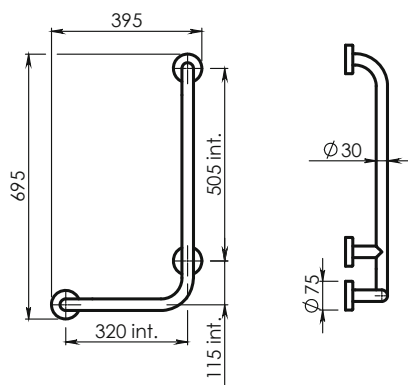

**6490-01.**

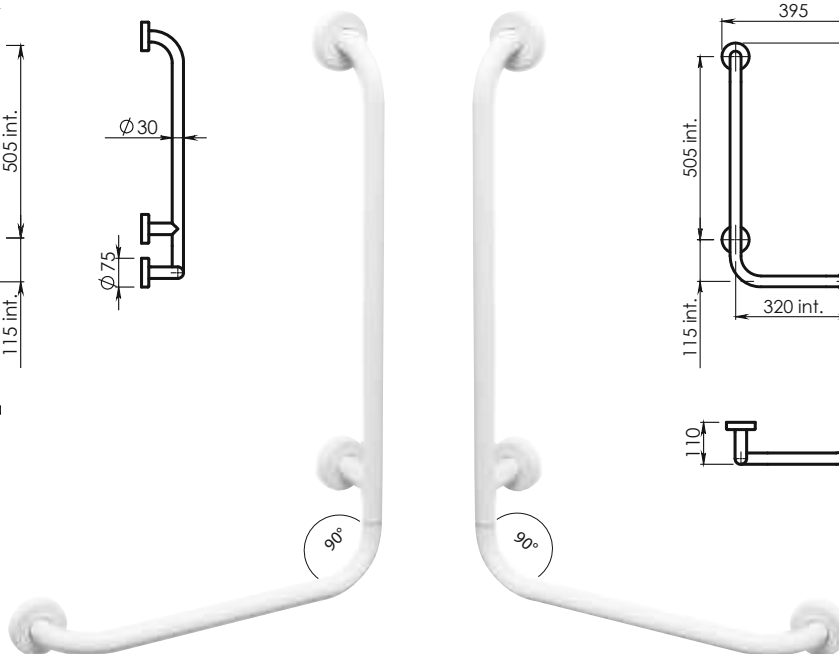
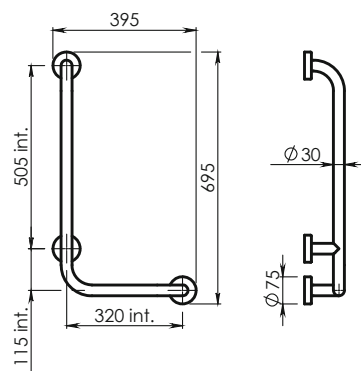

## CONTRACT.

### Sostegno a 90°

Holding handle 90° - Barre 90° - Wandhaltegriff 90°  
Soporte de 90° - Настенный поручень под углом 90°

#### 6445.

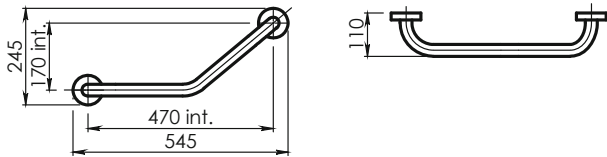

Reversibile  
Reversible

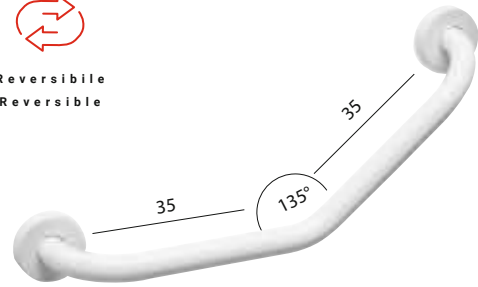

### Appoggio ribaltabile

Safety folding handle - Barre à abattant  
Klappgriff - Soporte móvil - Мобильный поручень

#### 6465.

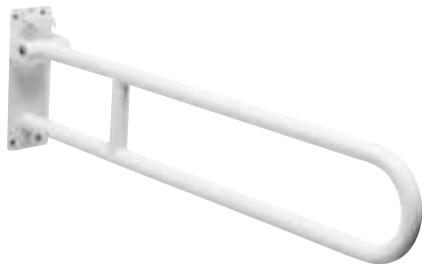
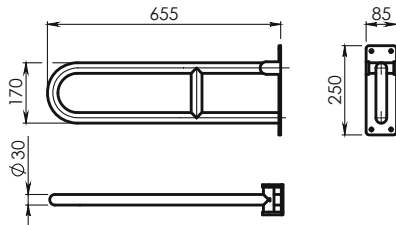

#### 6466.

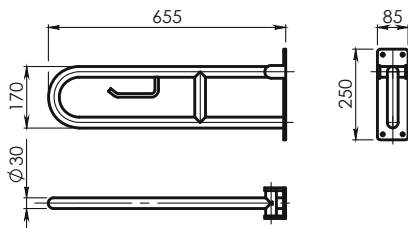

#### con portarotolo

with paper holder - avec porte rouleau  
mit Papierrollenhalter - con portarollo  
с бумагодержателям

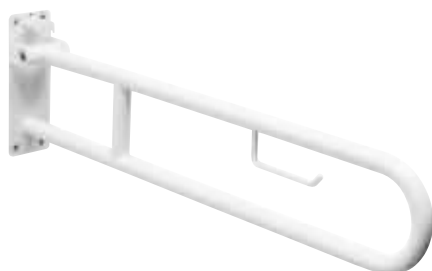

### Maniglione verticale parete-parete

Wall-wall upright handle  
Barre de relèvement  
verticale pari-paroi  
Senkrechter Griff Wand-Wand  
Barra vertical pared-pared  
Вертикальная ручка  
стена-стена

#### 6450.

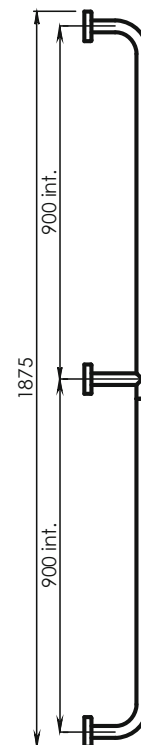
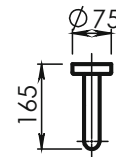

**Meccanismo di ribaltamento in posizione orizzontale e verticale** - Collapsible mechanism in horizontal and vertical position - Mécanisme de basculement en position horizontale et verticale - Kippmechanismus in waagerechter und in senkrechter Position - Mecanismo de abatimiento en posición horizontal y vertical - Откидной механизм в вертикальном и горизонтальном положении



# FRIEND

## Programma in resine termoplastiche

Program made of thermoplastic resins  
 Programme en résine thermoplastique  
 Programm aus Kunststoff - Programa en resinas termoplásticas  
 Программа из термопластичная смоль



02  
 Bianco  
 White

### 1021-20.

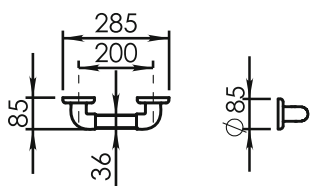

100% MADE  
 in Italy



CONFORME - IN CONFORMITY WITH UNI11064:2003

### 1021-30.

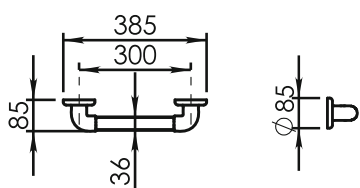

### 1021-45.

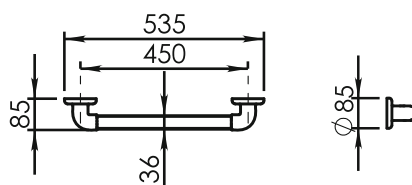

### 1083.

#### Sedile estensibile per vasca

Extending bath seat  
 Siège de baignoire extensible  
 Ausziehbarer Badewannensitz  
 Asiento extensible para bañera  
 Сиденье для ванны раздвижное



Regolabile  
 Adjustable

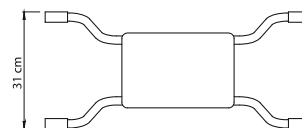
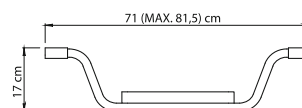

#### Alluminio e polietilene

Aluminum and Polyethylene - Aluminium et Polyéthylène  
 Aluminium und Polyethylen - Aluminio y Polietileno - Алюминий и Полиэтилен

### 1072.

#### Sgabello

Stool  
 Tabouret  
 Hocker  
 Taburete  
 Табурет



Regolabile  
 Adjustable

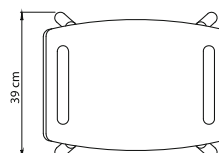
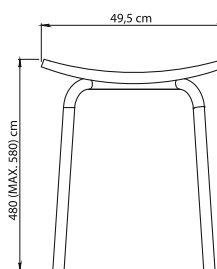

#### Alluminio e polietilene

Aluminum and Polyethylene - Aluminium et Polyéthylène  
 Aluminium und Polyethylen - Aluminio y Polietileno - Алюминий и Полиэтилен



 bamboom

# Himalaya.



## Realizzata in bambù

Made of bamboo

Réalisée en bambou

Hergestellt aus Bambus

Realizada en bambù

Изготовлено из бамбука



Con viti

With screws



Natural



Bambù

Bamboo



Save

the planet



GARANZIA

WARRANTY



35

Naturale  
Natural

# Himalaya.

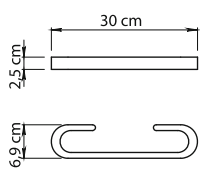
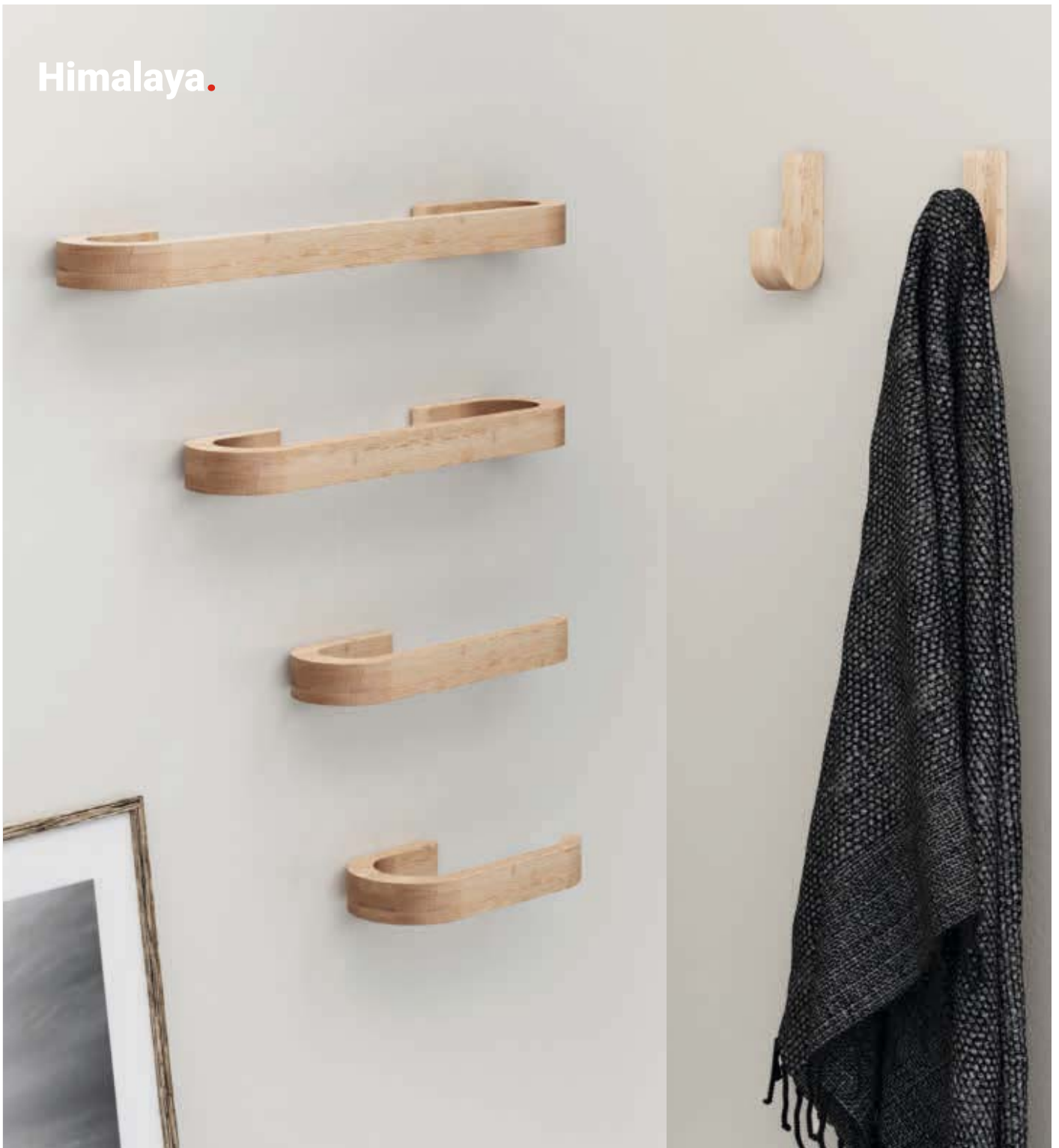

**HY21-30**

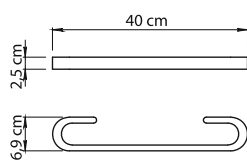

**HY21-40**

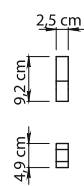

**HY26**  
2 pz - 2 pcs

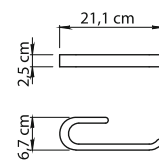

**HY70**

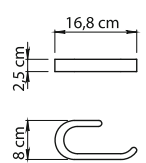

**HY24**

BAMBOOM .

GEDY

bamboom®

## Afrodite.

Realizzata in cemento e bambù

Made of concrete and bamboo

Réalisée en béton et bambou

Hergestellt aus Zement und Bambus

Realizada en cemento y bambú

Изготовлено из бетона и бамбука



Natural



Bambù

Bamboo



Save  
the planet



08  
Grigio  
Grey



4998

ø 7,5 x H11,5 cm



4911

L12,8 x P8,4 x H3 cm



4980

ø 7,6 x H17,2 cm



4906

L30,5 x P10,4 x H3,2 cm



4933

ø 9,3 x H47 cm

BAMBOOM .

GEDY

## Dafne.

### Realizzata in bambù

Made of bamboo

Réalisée en bambou

Hergestellt aus Bambus

Realizada en bambú

Изготовлено из бамбука

bambocom®



Natural



Bambù

Bamboo



Save

the planet



30

Noce

Walnut colour

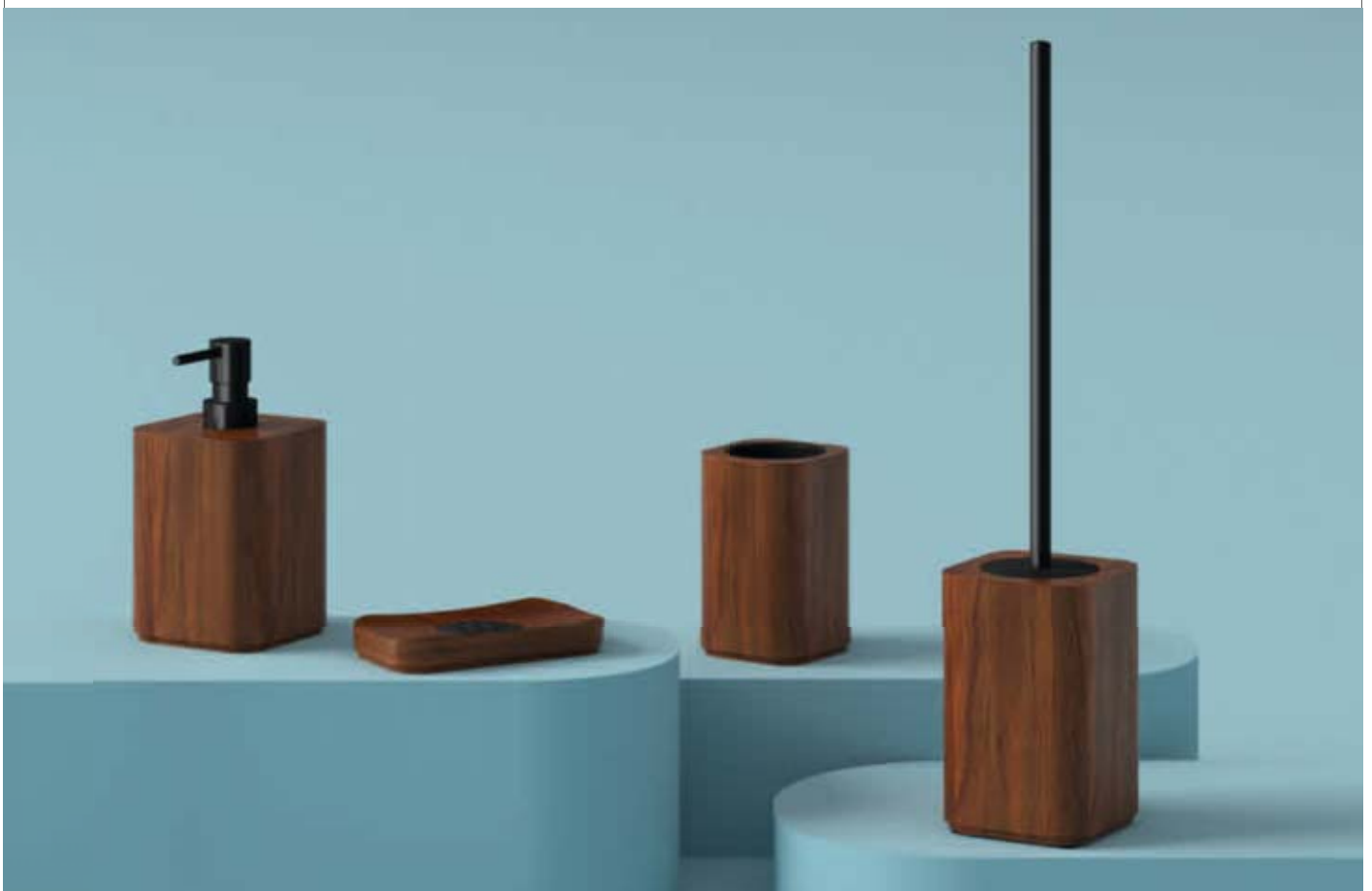

3998

L8 x P8 x H13 cm



3911

L14 x P8 x H2,2 cm



3980

L8 x P8 x H18,5 cm



3933

L9,5 x P9,5 x H47 cm

BAMBOOM .

GEDY

## Altea.

### Realizzata in bambù

Made of bamboo

Réalisée en bambou

Hergestellt aus Bambus

Realizada en bambú

Изготовлено из бамбука

bamboom®



Natural

Bambù

Bamboo

Save  
the planet

35  
Naturale  
Natural



**AL98**

ø 7 x H12 cm



**AL11**

ø 11,7 x H2 cm



**AL80**

ø 7 x H17,2 cm



**AL33**

ø 8,5 x H47,5 cm



BAMBOOM.

GEDY

Bonnie.



bamboom®



Natural

Bambù

Bamboo

Save

the planet

41

Naturale/nero matt  
Natural/matt black

Realizzata in bambù

Made of bamboo

Réalisée en bambou

Hergestellt aus Bambus

Realizada en bambú

Изготовлено из бамбука



35  
Naturale  
Natural



BN98

L7,4 x P7,4 x H11 cm



35  
Naturale  
Natural



BN11

L13,4 x P9,6 x H2,5 cm



BN80

L7,4 x P7,4 x H16,8 cm



BN33

L10 x P10 x H36,5 cm



BN34

L10 x P10 x H39,5 cm



BAMBOOM .

GEDY

bamboom®

# Ninfea.

Realizzata in resina e bambù

Made of resin and bamboo

Réalisée en résine et bambou

Hergestellt aus Harz und Bambus

Realizada en resina y bambú

Изготовлено из бамбука и смол



Natural



Bambù

Bamboo



Save

the planet



02

Bianco matt  
Matt white



14

Nero matt  
Matt black



1398

L12,8 x P5,6 x H8,5 cm



1311

L12,8 x P8,2 x H3 cm



1380

L12,8 x P5,6 x H15,7 cm



35  
Naturale  
Natural



1306

L29,7 x P15,2 x H2 cm



1333

L9,3 x P9,3 x H46,2 cm

BAMBOOM .

GEDY

bambocom®

Thea.

NEW



Natural

Bambù

Save

47  
Naturale/Verde  
Natural/Green

Bamboo

the planet

Realizzata in bambù e resina

Made of bamboo and resin

Réalisée en bambou et résine

Hergestellt aus Bambus und Harz

Realizada en bambú y resina

Изготовлено из бамбука и бамбука



07  
Verde  
Green



TH98

ø 7,5 x H10,5 cm



TH11

ø 12 x H2,3 cm



TH80

ø 7,5 x P8,5 x H15 cm



TH03

ø 9,5 x H7,3 cm



35  
Naturale  
Natural



TH06

L27,5 x P11,8 x H1,5 cm



TH33

ø 9,5 x H35 cm

BAMBOOM.

# Kenta.

GEDY

## Realizzate in bambù e metallo

Made of bamboo and metal

Réalisés en bambou et métal

Hergestellt aus Bambus und Metall

Realizadas en bambù y metal

Изготовлено из бамбука и металл



40

Naturale/Bianco matt  
Natural/Matt white



41

Naturale/Nero matt  
Natural/Matt black



Natural



Save  
the planet



Bambù  
Bamboo



1409 - 5 lt

ø 20,5 x 26 x 26,5 cm



1309 - 3 lt

ø 17 x 22 x 25 cm



Soft close

BAMBOOM.

# Trilly.

GEDY

## Acciaio inox e bambù

Stainless steel and bamboo

Acier inoxydable et bambou

Edelstahl und bambus

Acero inox y bambú

Нержавеющей стали и Бамбука



41  
Naturale/Nero matt  
Natural/Matt black



GARANZIA  
WARRANTY



Natural



Save  
the planet



Bambù  
Bamboo



TR31

H84 cm

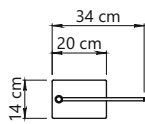

TR32

H63 cm



BAMBOOM .

# Panda.

GEDY

## Bambù

Bamboo  
Bambou  
Bambus  
Bambú  
Бамбука



35  
Naturale  
Natural



Natural



Save  
the planet



Bambù  
Bamboo



1031

H190 cm

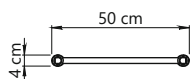



BAMBOOM.

# Juncos.

GEDY



41

Naturale/Nero matt  
Natural/Matt black

## Bambù e metallo

Bamboo and metal  
Bambou et métal  
Bambus und Metall  
Bambú y metal  
Бамбука и металл



Con biadesivo  
With double  
sided tape



Natural



Save  
the planet



Bambù  
Bamboo



1126

ø 5 x P3,8 cm



1127

L10 x P3,8 x H5 cm



1126

L5 x P3,8 x H5 cm



1127

L10 x P3,8 x H5 cm



BAMBOOM.

# Merlino.

GEDY



Natural



Save  
the planet



Bambù  
Bamboo



35  
Naturale  
Natural

## Realizzate in bambù

Made of bamboo  
Réalisés en bambou  
Hergestellt aus Bambus  
Realizadas en bambù  
Изготовлено из бамбука



2026

L2,5 x P5,7 x H12,5 cm



# Ilan.

NEW

GEDY



Natural



Save  
the planet



Bambù  
Bamboo



35  
Naturale  
Natural

## Bambù

Bamboo  
Bambou  
Bambus  
Bambú  
Бамбука



IA06

L34 x P23 x H1,8 cm



BAMBOOM.

# Yoshi.

GEDY



Natural



Save  
the planet



Bambù  
Bamboo



05  
Blu  
Blue



08  
Grigio  
Grey

## Bambù e poliestere

Bamboo and polyester - Bambou et polyester

Bambus und polyester - Bambú y poliéster - Бамбука и Полиэстер



1338 - 87 lt

L53 x P34 x H51 cm

# Tatami.

GEDY



Natural



Save  
the planet



Bambù  
Bamboo



02  
Bianco  
White



14  
Nero  
Black

## Bambù e cotone

Bamboo and cotton - Bambou et coton - Bambus und Baumwolle

Bambú y algodón - бамбук и хлопок



TA38 - 68 lt

L35,5 x P35,5 x H63 cm



BAMBOOM .

# Nature.

GEDY

## Bambù

Bamboo  
Bambou  
Bambus  
Bambú  
Бамбука



35  
Naturale  
Natural



Natural



Save  
the planet



Bambù  
Bamboo



2490

L27 x P12 x H61 cm



ΕΚϋπλα



EKOPLA'.

GEDY

# Seventy.

design Matteo Thun

NEW

100% MADE  
in Italy



Save the  
planet



Riciclabile  
Recyclable



Riciclato  
Recycled



14  
Nero matt  
Matt black

## Materiale plastico riciclato

Recycled plastic

Plastique recyclé

Recyceltes Kunststoffmaterial

Material plástico reciclado

Переработанный пластик



6398

L6,5 x P6,5 x H12,2 cm



6312

L12,4 x P8 x H2,1 cm



6382

L6,5 x P7,1 x H16 cm



6333

L9 x P9 x H38,8 cm

design  
R&S Gedy

# Seventy.

GEDY

NEW



08  
Grigio matt  
Matt grey



14  
Nero matt  
Matt black



22  
Bianco matt  
Matt white



Save the  
planet



Riciclabile  
Recyclable



Riciclato  
Recycled

100% MADE  
in Italy



07  
Verde matt  
Matt green



17  
Verde salvia matt  
Matt green sage



6333

L9 x P9 x H38,8 cm

**Materiale plastico riciclato**

Recycled plastic

Plastique recyclé

Recyceltes Kunststoffmaterial

Material plástico reciclado

Переработанный пластик



**GEDY S.p.A**

Via dell'Industria, 6

21040 Origgio (VA) - Italia

Tel. +39.02.96.95.01

Fax +39.02.96.73.43.01

[www.gedy.com](http://www.gedy.com) - [info@gedy.com](mailto:info@gedy.com)

